

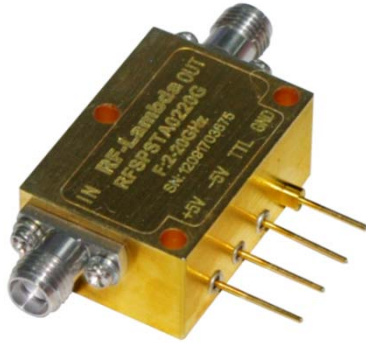

Reflective 2-20.0GHz Coaxial SPST Switch



Features

- Wide Band Operation 2-20.0GHz
- High Power Handle Capability up to 5W upon request.
- TTL compatible driver include
- Fast Switching Speed
- Low Insertion Loss and High Isolation
- Temperature Range -40°C~+85°C
- Customization available upon request

Specification	Reflective type		
	PN: RFSPSTR0220G		
	Low	Med	High
Frequency Range(GHz)	2	11	20
Insertion Loss(dB)	2.0dB typ. @2GHz	2.5dB typ. @11GHz	3.0dB typ. @20GHz
VSWR	1.8	1.8	2
Isolation(dB)	80	80	70
Switching Speed(ns)	150	200	250
P1dB Power (dBm)		31.5	
Absolutely max. Power (W)			1-5W upon request
Weight (g)	15		
IIP3 (Input IP3) dBm	42.92		
Impedance(Ohms)	50Ω		
Power Supply (V)	+/-5 V DC		
Current(mA)	50mA (+5V) 30mA (-5V)		
Input Connector	SMA-Female		
Output Connector	SMA-Female		
Finishing	Gold Plating		
Material	Brass		
Seal	Hermetically Sealed		
Control (TTL Driver Included)	TTL Control		
	TTL	Status	
	0	OFF	
	1	ON	

Reflective Coaxial Single Pole Single Throw Switch 2-20.0GHz



RF-LAMBDA

The power beyond expectations

RFSPSTR0220G

Reflective Coaxial Single Pole Single Throw Switch 2-20.0GHZ

Absolute Maximum Ratings	
Biassing	+/-5 V
TTL Control Voltage	+5V/0V
Input RF power	20dBm
Storage Temperature (C°)	-50 ~ +125

Biassing Up Procedure	
Step 1	-5V
Step 2	+5V
Step 3	TTL
Power OFF Procedure	
Step 1	+5V
Step 2	-5V
Step 3	TTL

Environment specifications	
Operational Temperature (C°)	-45 ~ +85
Storage Temperature (C°)	-50 ~ +125
Altitude	30,000 ft (Controlled environment)
Vibration	15g rms (15 degree 2KHz)
Humidity	100% RH at 35c, 95%RH at 40 deg c
Shock	20G for 11msc

Ordering Information		
Part No	ECCN	Description
RFSPSTR0220G	EAR99	SPST 2-20GHz PIN Diode Switch



Median Lifetime (Tm) vs. Channel Temperature (Tch)

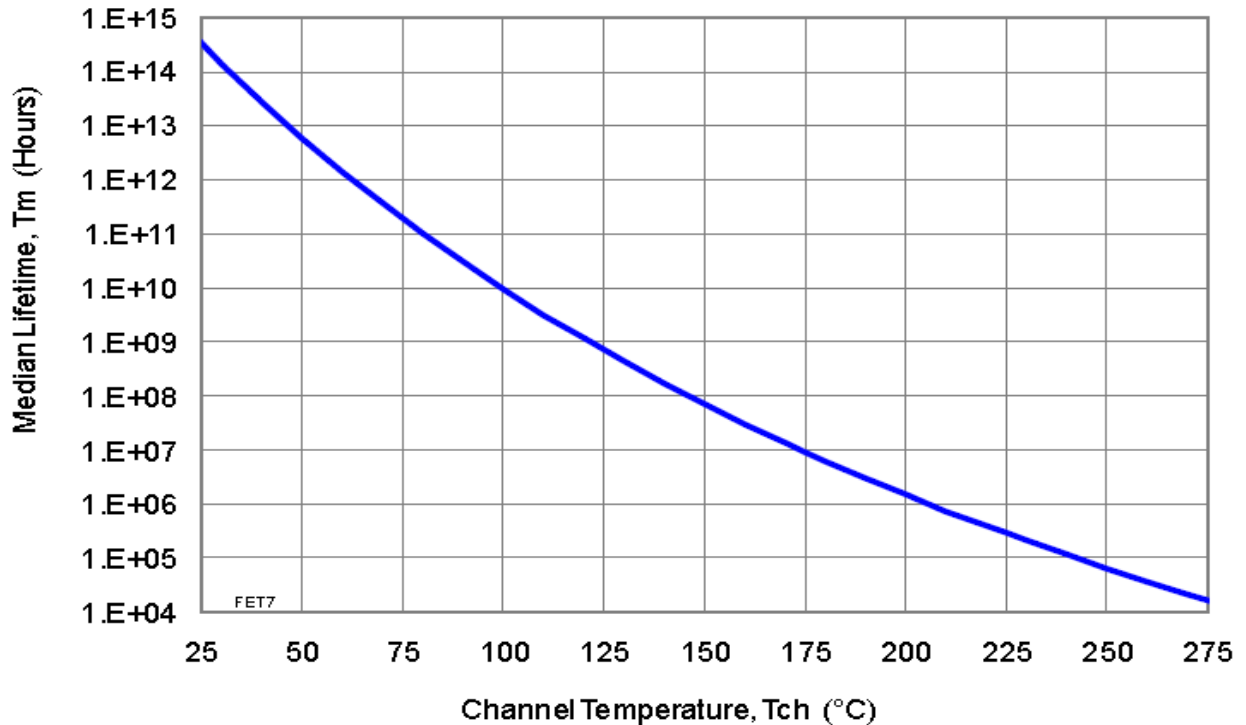



RF-LAMBDA

The power beyond expectations

RFSPSTR0220G

Reflective Coaxial Single Pole Single Throw Switch 2-20.0GHz

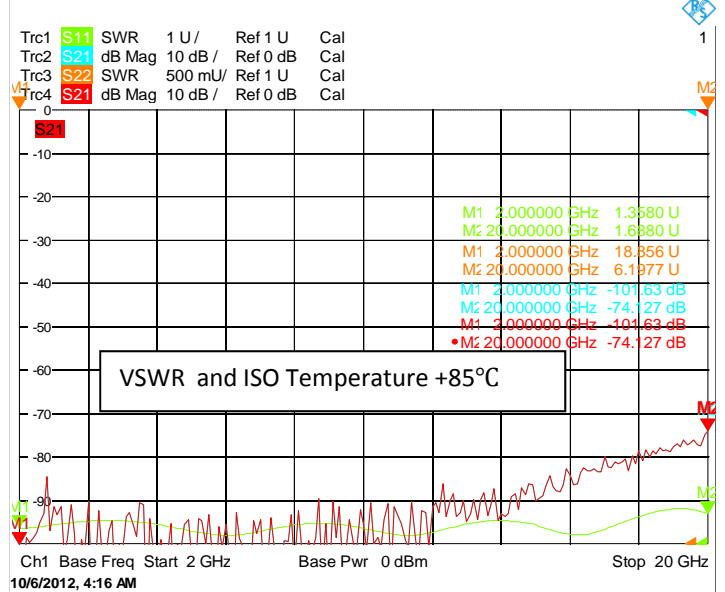
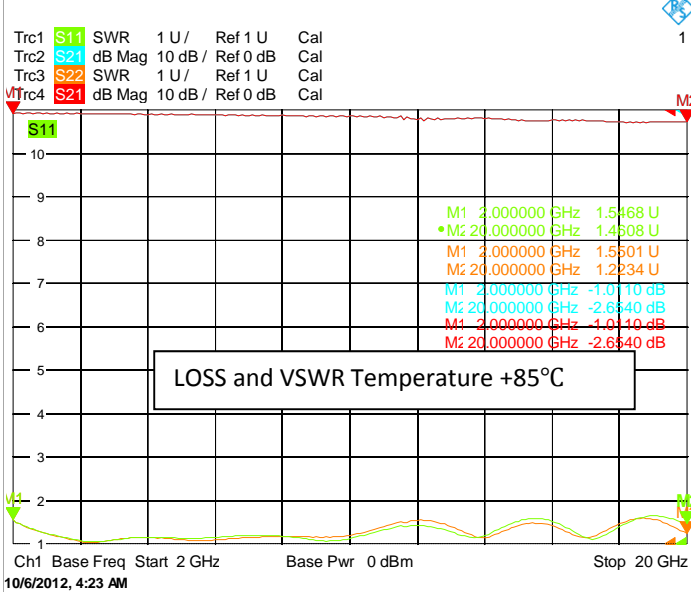
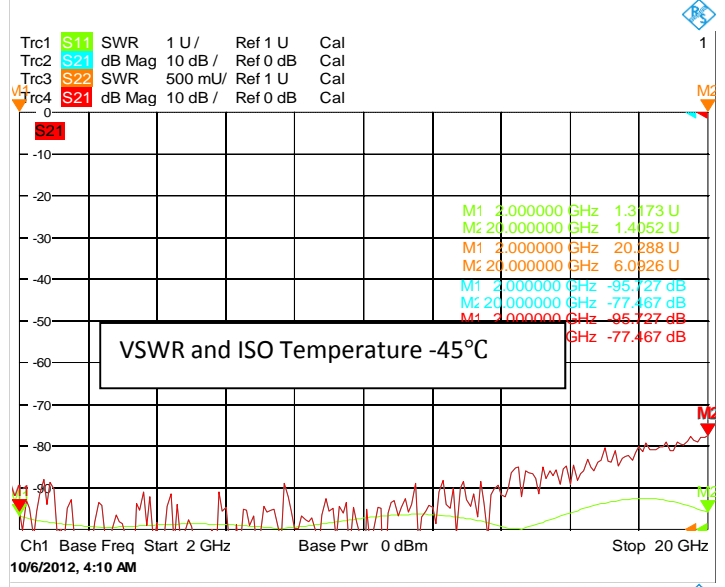
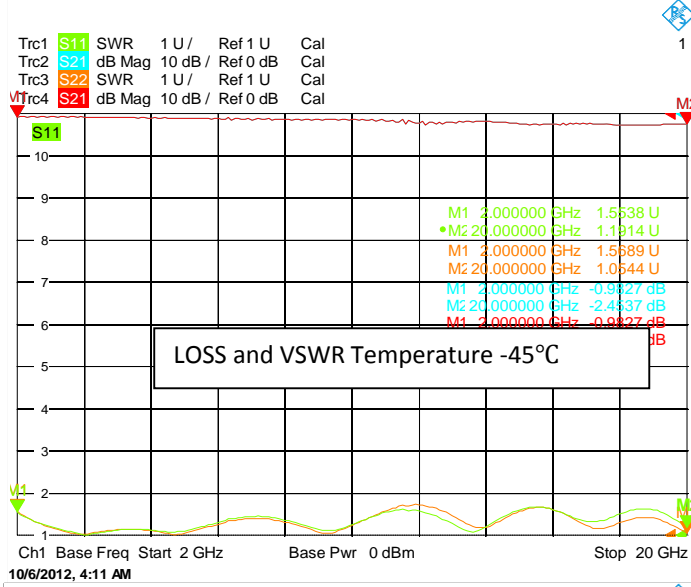
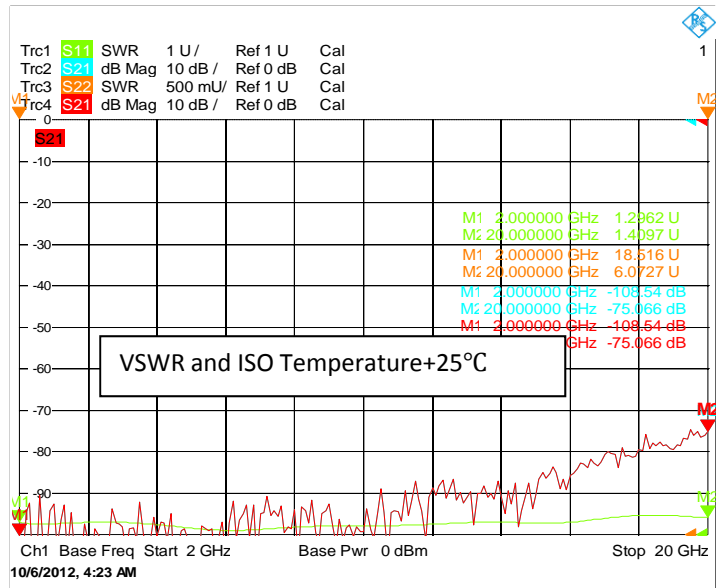
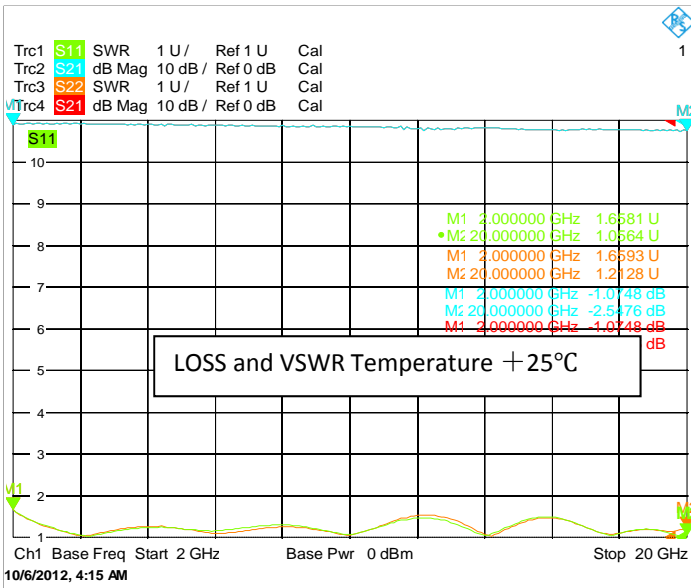



RF-LAMBDA

The power beyond expectations

RFSPSTR0220G

1dB Compression Point

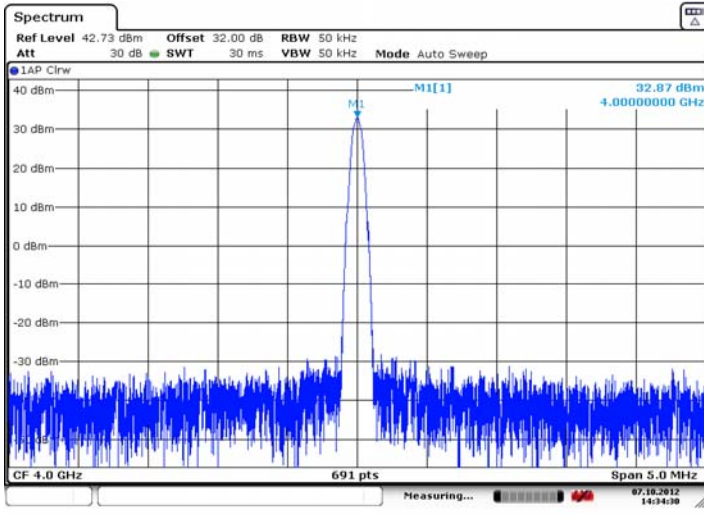

Date: 7.OCT.2012 14:34:30

IP3 – INPUT IP3 Point

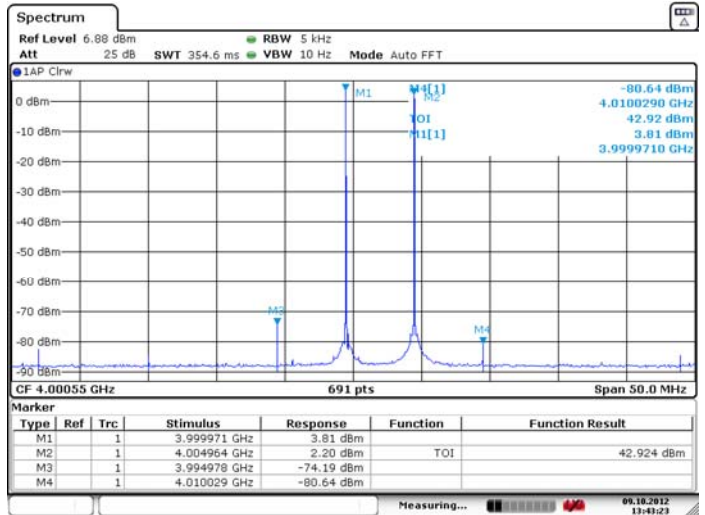

Date: 9.OCT.2012 13:43:23

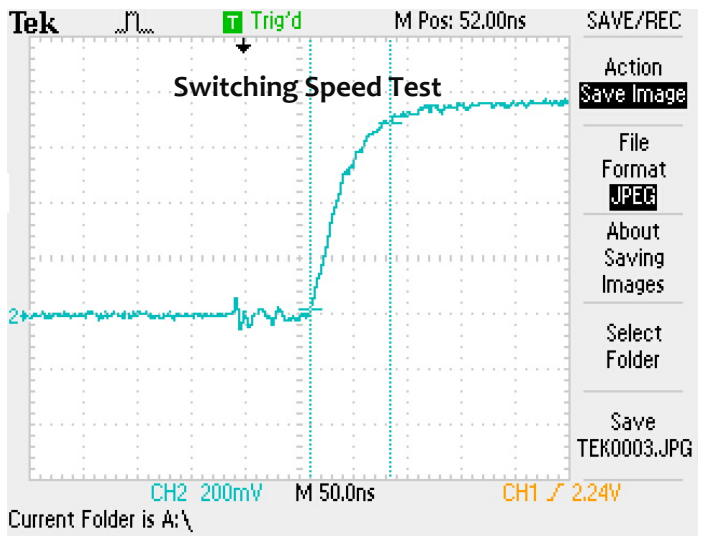
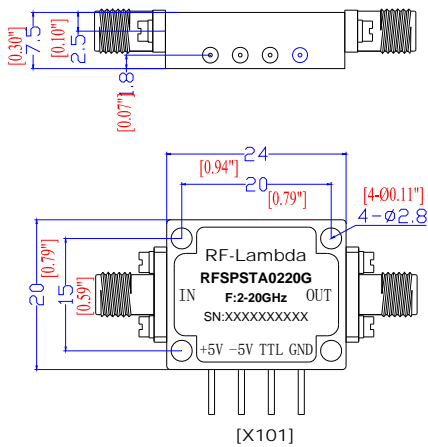

Important Notice

The information contained herein is believed to be reliable. RF-Lambda makes no warranties regarding the information contained herein. RF-Lambda assumes no responsibility or liability whatsoever for any of the information contained herein. RF-Lambda assumes no responsibility or liability whatsoever for the use of the information contained herein. The information contained herein is provided "AS IS, WHERE IS" and with all faults, and the entire risk associated with such information is entirely with the user. All information contained herein is subject to change without notice. Customers should obtain and verify the latest relevant information before placing orders for RF-Lambda products. The information contained herein or any use of such information does not grant, explicitly or implicitly, to any party any patent rights, licenses, or any other intellectual property rights, whether with regard to such information itself or anything described by such information.

RF-Lambda products are not warranted or authorized for use as critical components in medical, life-saving, or life sustaining applications, or other applications where a failure would reasonably be expected to cause severe personal injury or death.

Reflective Coaxial Single Pole Single Throw Switch 2-20.0GHz