

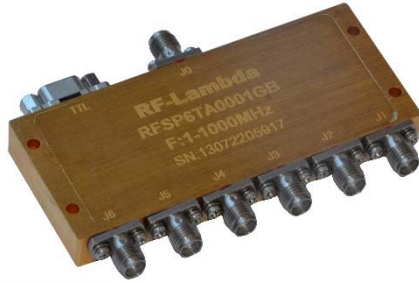

Absorptive 0.5-4GHz Coaxial SP6T Switch



Features

- Wide Band Operation 0.5-4GHz
- High Power Handle Capability up to 5W upon request.
- TTL compatible driver include
- Fast Switching Speed
- Low Insertion Loss and High Isolation
- Temperature Range -45°C~+85°C
- Customization available upon request

Specification	Absorptive type						
	PN: RFSP6TA5M04G						
	Low	Med	High				
Frequency Range(GHz)	0.5	2.25	4				
1.5	2dB typ.	1.8dB typ.	2.5dB typ.				
VSWR	1.5	1.5	1.5				
Isolation(dB)	90	90	90				
Switching Speed(ns)	100	100	100				
P1dB Power (dBm)		24					
Absolutely max. Power (W)			1				
Weight (g)	300						
IIP3 (Input IP3) dBm	40						
Impedance(Ohms)	50Ω						
Power Supply (V)	+/-5 V DC						
Current(mA)	240mA (+5V) 80mA (-5V)						
Input Connector	SMA-Female						
Output Connector	SMA-Female						
Finishing	Gold Plating						
Material	Brass						
Seal	Hermetically Sealed						
Control (TTL Driver Included)	TTL Control						
	C6	C5	C4	C3	C2	C1	Status
	1	1	1	1	1	0	Jo-J1
	1	1	1	1	0	1	Jo-J2
	1	1	1	0	1	1	Jo-J3
	1	1	0	1	1	1	Jo-J4
	1	0	1	1	1	1	Jo-J5
0	1	1	1	1	1	Jo-J6	

Absorptive Coaxial Single Pole Six Throw Switch 0.5-4GHz



RF-LAMBDA

The power beyond expectations

RFSP6TA5M04G

Absolute Maximum Ratings	
Biassing	+/-5 V
TTL Control Voltage	+5V/0V
Input RF power	+23dBm
Storage Temperature (C°)	-50 ~ +125

Biassing Up Procedure	
Step 1	-5V
Step 2	+5V
Step 3	TTL
Power OFF Procedure	
Step 1	+5V
Step 2	-5V
Step 3	TTL

Environment specifications	
Operational Temperature (C°)	-45 ~ +85
Storage Temperature (C°)	-50 ~ +125
Altitude	30,000 ft (Controlled environment)
Vibration	55g rms (15 degree 2KHz)
Humidity	100% RH at 35c, 95%RH at 40 deg c
Shock	20G for 11msc

Ordering Information		
Part No	ECCN	Description
RFSP6TA5M04G	EAR99	SP6T 0.5-4GHz PIN Diode Switch



Median Lifetime (Tm) vs. Channel Temperature (Tch)

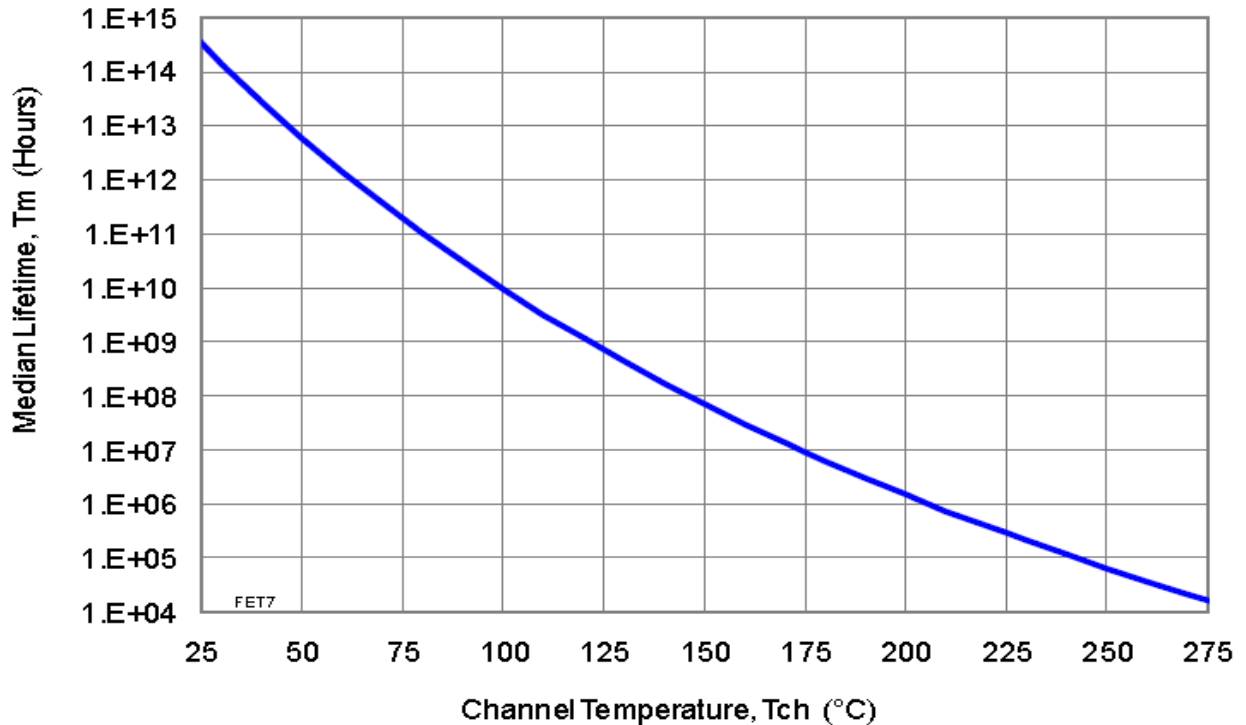

Absorptive Coaxial Single Pole Six Throw Switch 0.5-4GHz



RF-LAMBDA

The power beyond expectations

RFSP6TA5M04G

Absorptive Coaxial Single Pole Six Throw Switch 0.5-4GHz

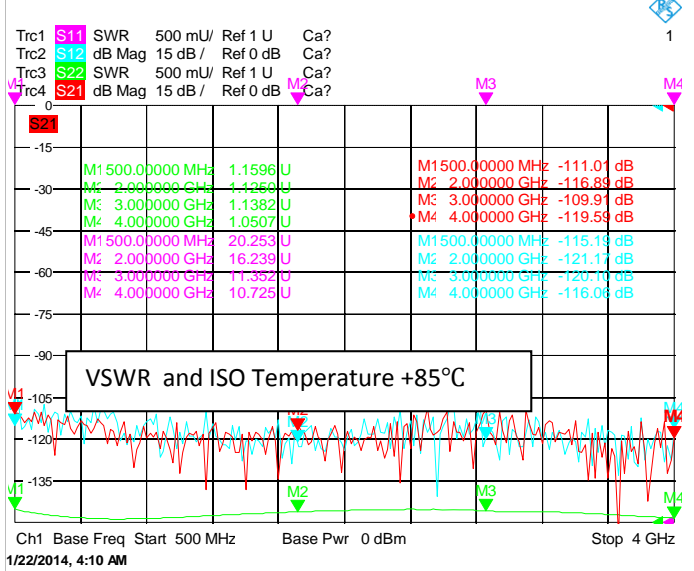
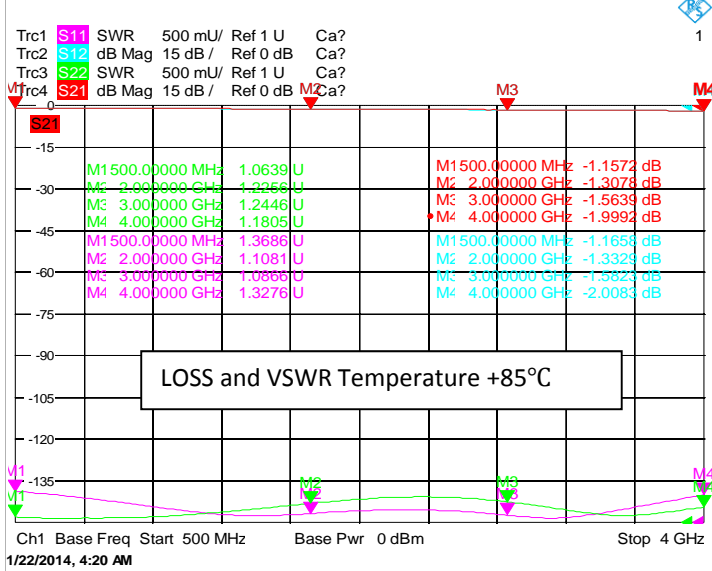
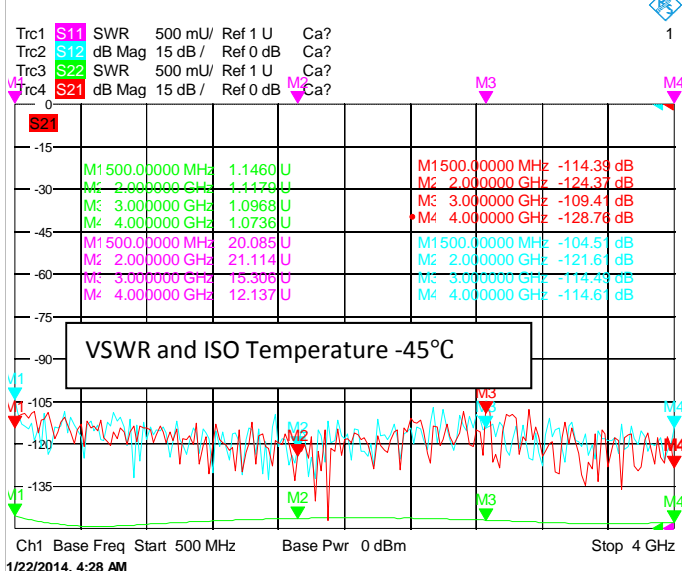
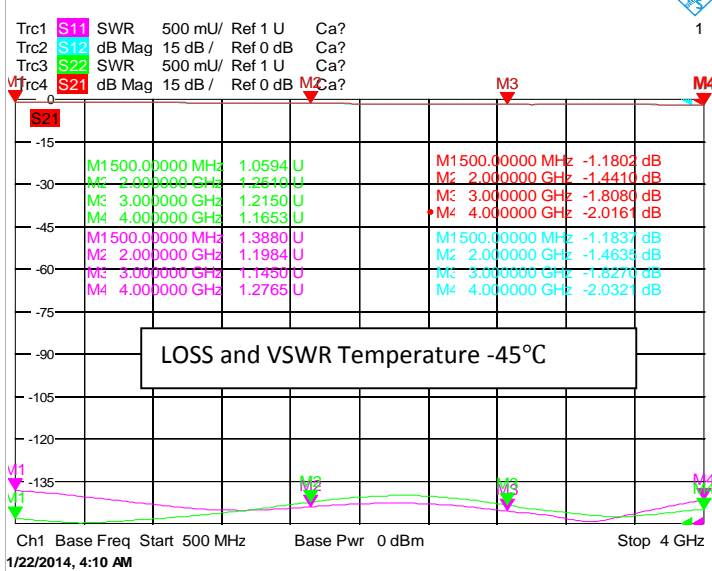
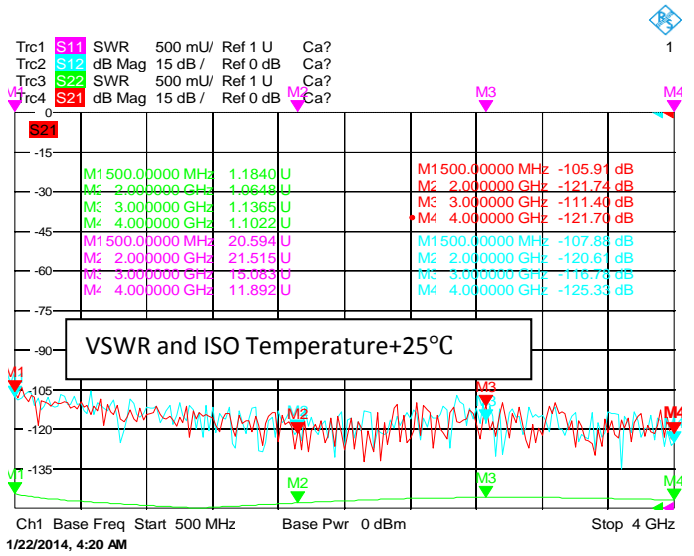
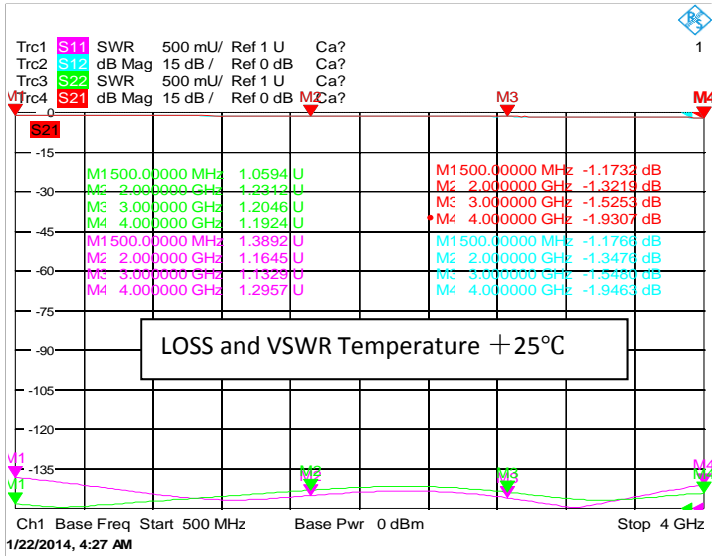



RF-LAMBDA

The power beyond expectations

RFSP6TA5M04G

1dB Compression Point

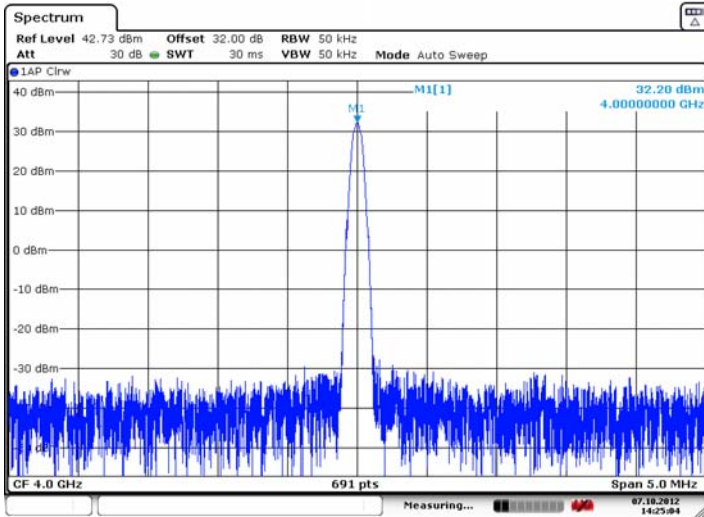

Date: 7.OCT.2012 14:25:04

IP3 – INPUT IP3 Point

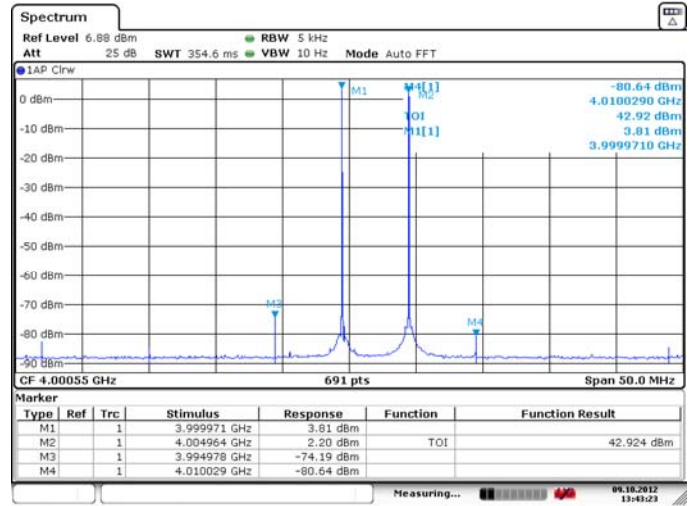

Date: 9.OCT.2012 13:43:23

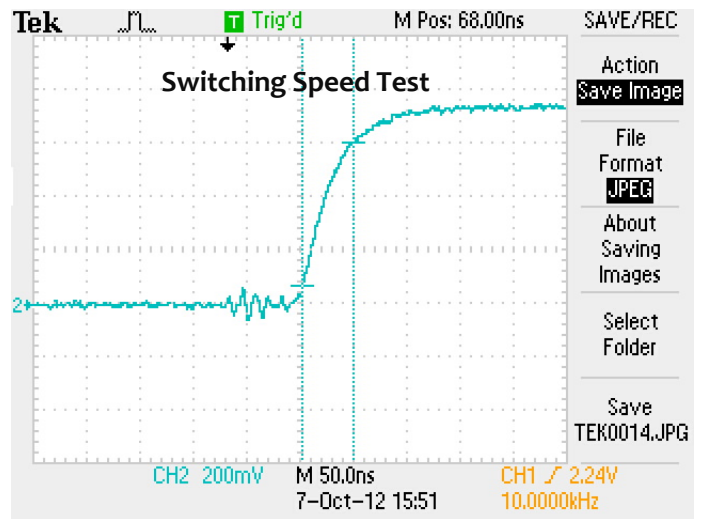
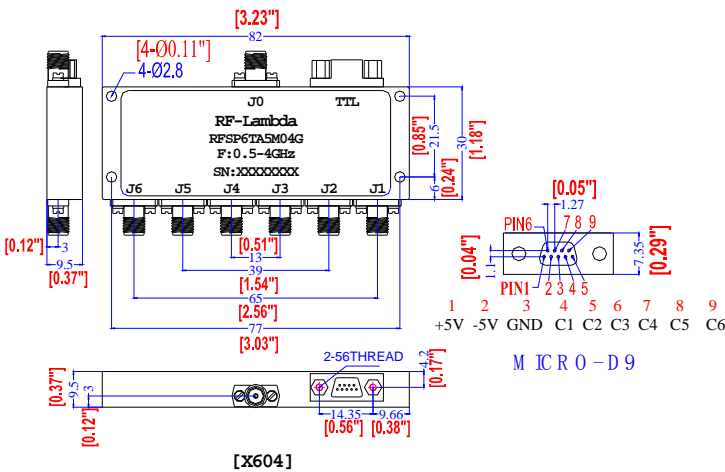

Important Notice

The information contained herein is believed to be reliable. RF-Lambda makes no warranties regarding the information contained herein. RF-Lambda assumes no responsibility or liability whatsoever for any of the information contained herein. RF-Lambda assumes no responsibility or liability whatsoever for the use of the information contained herein. The information contained herein is provided "AS IS, WHERE IS" and with all faults, and the entire risk associated with such information is entirely with the user. All information contained herein is subject to change without notice. Customers should obtain and verify the latest relevant information before placing orders for RF-Lambda products. The information contained herein or any use of such information does not grant, explicitly or implicitly, to any party any patent rights, licenses, or any other intellectual property rights, whether with regard to such information itself or anything described by such information.

RF-Lambda products are not warranted or authorized for use as critical components in medical, life-saving, or life sustaining applications, or other applications where a failure would reasonably be expected to cause severe personal injury or death.

Absorptive Coaxial Single Pole Six Throw Switch 0.5-4GHz