

Hermetically Sealed Reflective Coaxial SP4T Switch 0.5GHz-6GHz

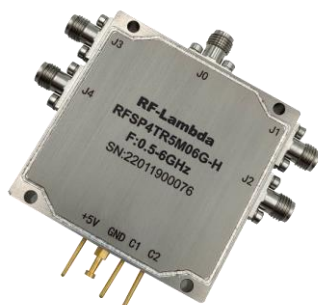

Features

- TTL compatible driver included
- Fast Switching Speed
- High Power Cold Switching
- Insertion Loss 1.8dB
- Isolation 40dB Typical
- 50 Ohm Matched

Product Description

RFSP4TR5M06G-H is a hermetically sealed reflective coaxial single pole four throw switch with a frequency range of 0.5 to 6GHz.

The maximum power input of this switch is 50 Watt. The insertion loss is 1.8dB with a typical isolation of 40dB.

The product features of fast switching speed, low insertion loss and high isolation.

The working temperature of this product is between - 40°C and + 85°C

Typical Applications

- Wireless Infrastructure
- Military and Aerospace Applications
- Test Instrumentation
- Radar Systems
- 5G Wireless Communications
- Microwave Radio Systems
- TR Modules
- Research and Development
- Cellular Base Stations

Electrical Specifications(TA = +25°C), Vdd = +5V, TTL = 0 / +5V

Parameter	Min	Typ	Max	Min	Typ	Max	Units
Frequency Range		0.5 - 3			3 - 6		GHz
Insertion Loss		1.8	2.0		2.8	2.9	dB
Insertion Loss Temperature Coefficient		0.003			0.003		dB/ °C
Isolation	35	45		33	40		dB
Input VSWR		1.4	1.6		1.5	1.8	: 1
Output VSWR		1.4	1.6		1.8	1.8	: 1
RF Input Power (Pulsed, 1% Duty Cycle, 10us pulse width)			51.2			51.2	dBm
DC Power Dissipation		2			2		W
0.1dB Compression Point (P0.1dB)		47			47		dBm
IIP3		51			50		dBm
Switching Speed		300			300		ns
Bias Current (+5V)			200Typ.				mA
Weight			0.14				lbs
Impedance			50				Ω
Input / Output Connectors	SMA-Female(Input) – SMA-Female(Output)						
Package	Hermetically Sealed (Laser Welded)						

Absolute Maximum Ratings

Parameter	Rating
Biasing	+5V±10%

Notes:

1. If the device operates in high power state, recommend keeping case temperature lower than 60°C.
2. Cold Switching: Before changing any TTL signal(s), the RF input power must be blanked or the switch could be damaged.

Environmental Specifications and Test Standards

Parameter	Description
Operational Temperature	-40°C to +85°C (Case Temperature)
Storage Temperature	-50°C to +105°C
Thermal Shock	-40°C → +85°C (5 Cycles / 10 hours)
**Random Vibration	MIL-STD-202G Table 214-I, Test Condition Letter C 1.5 Hours Per Axis
High Temperature Burn In	Temperature +85°C for 72 Hours
Shock	1. Weight >20g, 50g half sine wave for 11ms, Speed variation 3.44m/s 2. Weight <=20g, 100g Half sine wave for 6ms, Speed variation 3.75m/s 3. Total 18 times (6 directions, 3 repetitions per direction).
Altitude	Standard: 30,000 Ft (Epoxy Sealed Controlled Environment) Optional: Hermetically Sealed (60,000 ft. 1.0 PSI min)
Hermetically Sealed (Optional)	MIL-STD-883 (For Hermetically Sealed Units)

** For vibration testing details please see additional information section.

Typical Performance Plots

Insertion Loss @+25°C

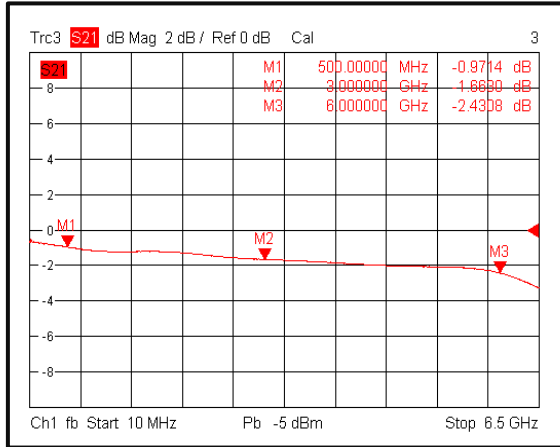

Input VSWR @+25°C

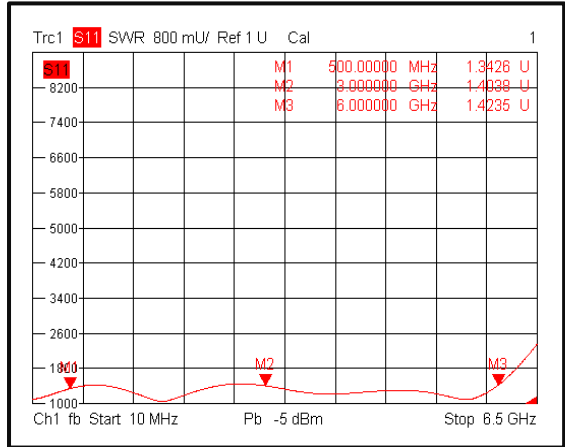

Output VSWR @+25°C

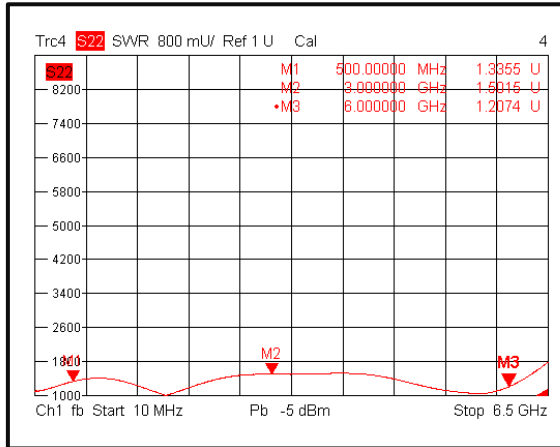

Isolation @+25°C

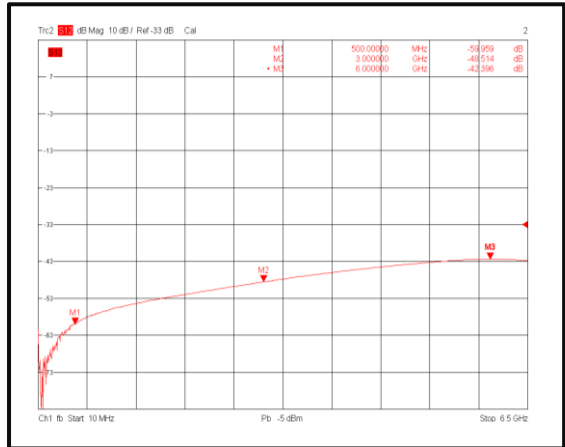

Insertion Loss @-40°C

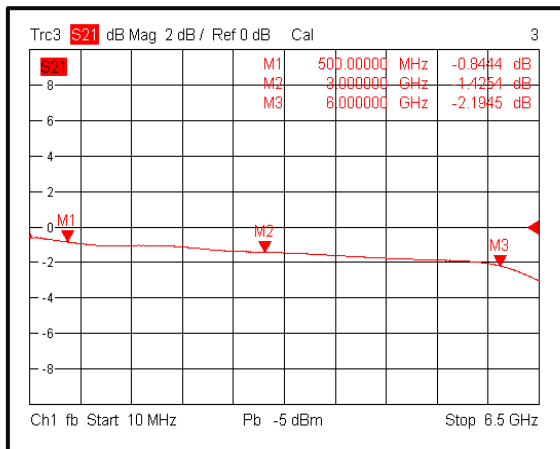

Input VSWR @-40°C

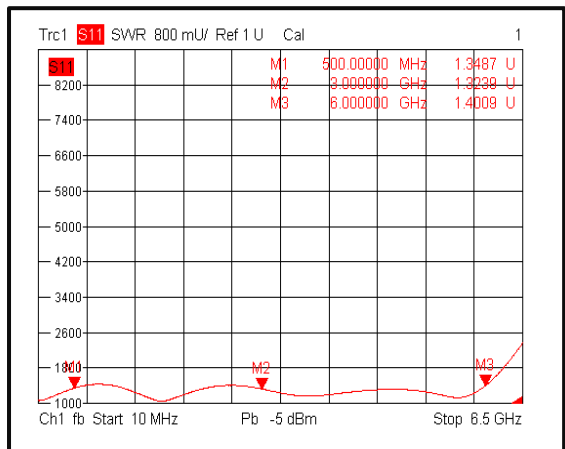

Typical Performance Plots

Output VSWR @-40°C

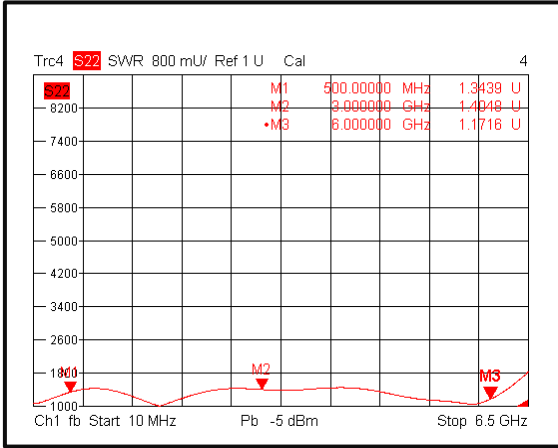

Isolation @-40°C

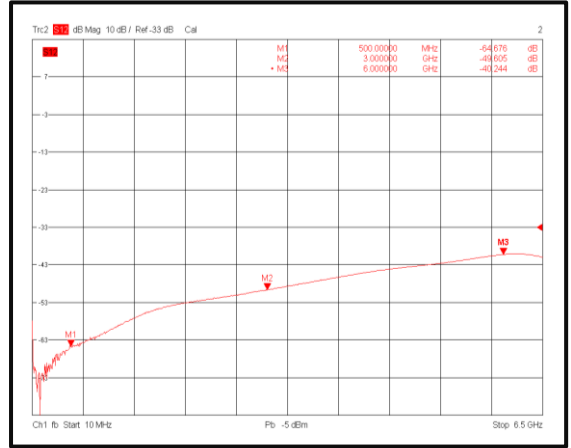

Insertion Loss @+85°C

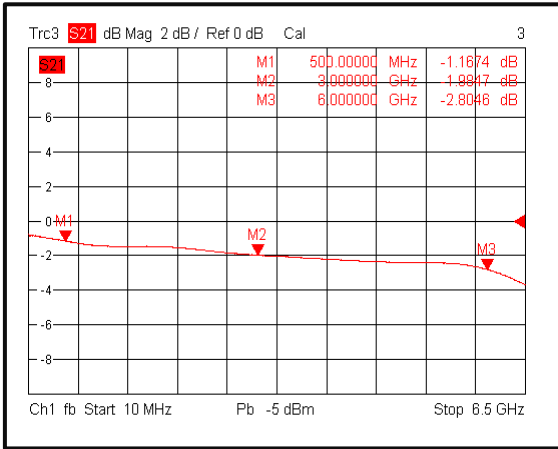

Input VSWR @+85°C

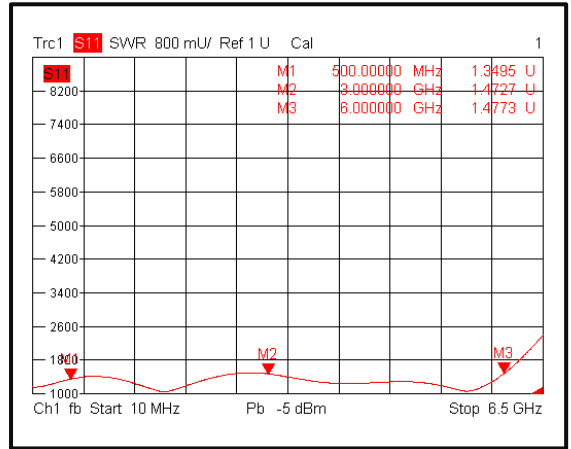

Output VSWR @+85°C

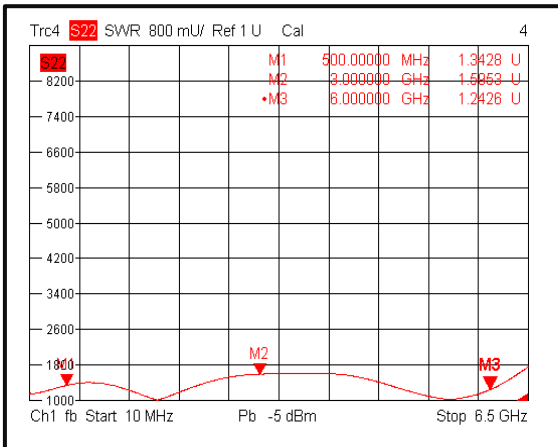

Isolation @+85°C

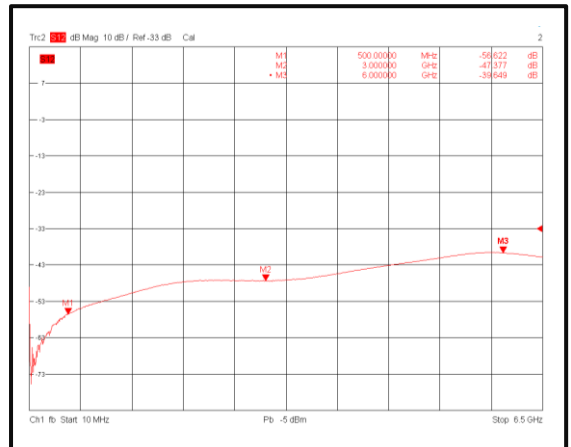

Typical Performance Plots

Insertion Loss Temperature Coefficient

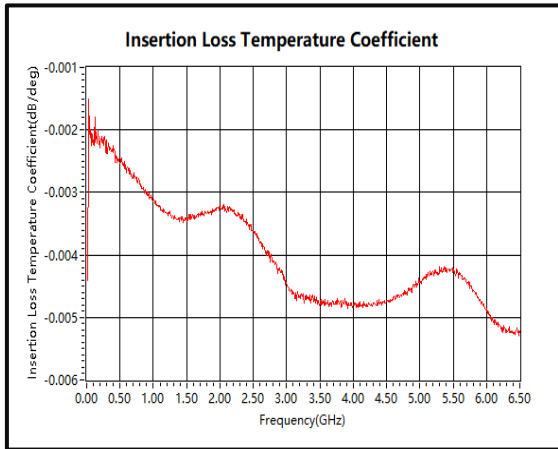

Insertion Loss vs. Temperature

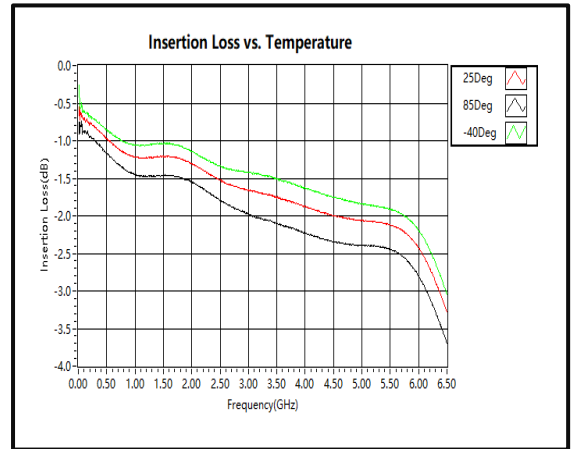

IIP3

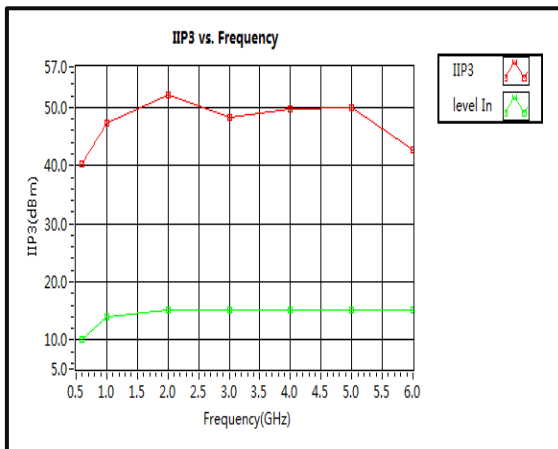

Input Power vs. Frequency (CW)

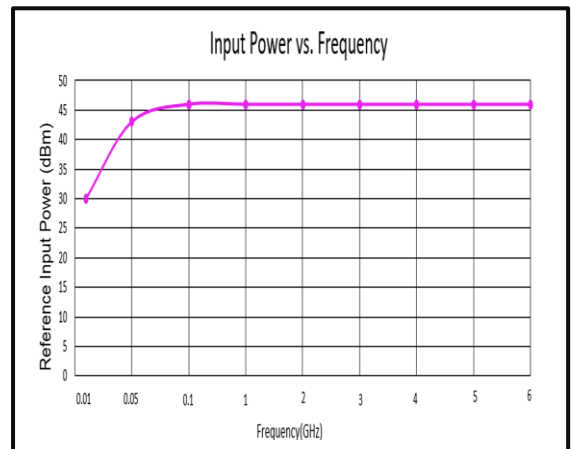

Switching Speed

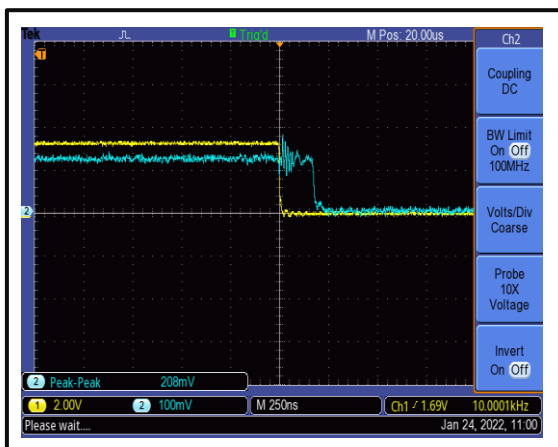

Switching Speed

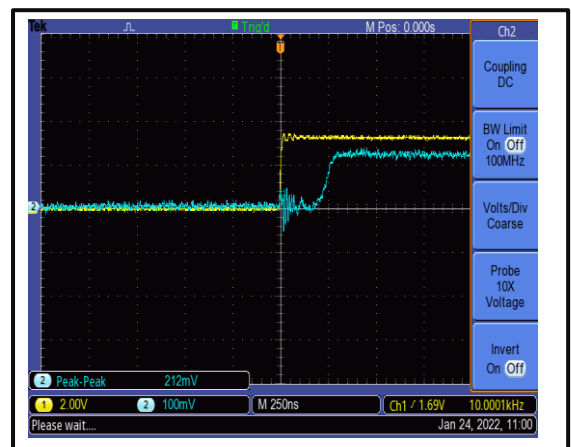

Outline Drawing

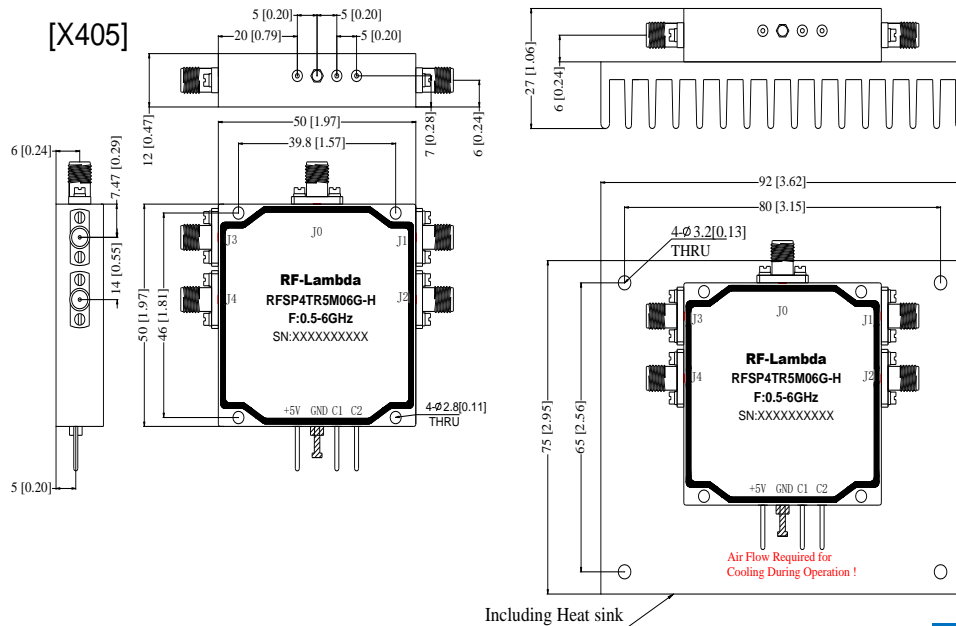

Truth Table

TTL Control Voltage	Low(0)=0~0.8V	
THRESHOLD	High(1)=2.8~5V	
Control Input TTL	Signal Path State	
C1	C2	
0	0	J0-J1
0	1	J0-J2
1	0	J0-J3
1	1	J0-J4
Control Pin		Customization available upon request

Notes:

1. Package Material: Aluminum
2. Finish: Nickel Plated
3. All dimensions are in millimeters [inches].
4. Housing Tolerances ± 0.1 [0.004] unless otherwise specified(Excl Heat Sink).
5. Heatsink Required - Mandatory for High Power Operation. Matching heatsink is listed on our website. If customer would like to use their own cooling method, please make sure the amplifier will operate under the specs that listed in page 2 of this datasheet.
6. Standard torque wrench must be used to secure RF connectors.

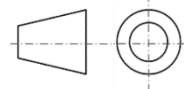

Additional Information

Documentation	Webpage
ESD Policy	https://rflambda.com/pdf/rflambda_esd_control.pdf
Heatsink Lookup Specifications	https://rflambda.com/search_heatsink.jsp
Connector Torque Specifications	https://www.rflambda.com/pdf/Torque_Specifications.pdf
Random Vibration Test Standard	https://www.rflambda.com/pdf/rflambda_random_vibration_MIL-STD-202G.pdf

Ordering Information

Part Number	Modification	Description
RFSP4TR5M06G-H	Standard	0.5GHz-6GHz Hermetically Sealed SP4T PIN Diode Switch

Important Notice

The information contained herein is believed to be reliable. RF-Lambda makes no warranties regarding the information contained herein. RF-Lambda assumes no responsibility or liability whatsoever for any of the information contained herein. RF-Lambda assumes no responsibility or liability whatsoever for the use of the information contained herein. The information contained herein is provided "AS IS, WHERE IS" and with all faults, and the entire risk associated with such information is entirely with the user. All information contained herein is subject to change without notice. Customers should obtain and verify the latest relevant information before placing orders for RF-Lambda products. The information contained herein or any use of such information does not grant, explicitly or implicitly, to any party any patent rights, licenses, or any other intellectual property rights, whether with regard to such information itself or anything described by such information. RF-Lambda products are not warranted or authorized for use as critical components in medical, life-saving, or life sustaining applications, or other applications where a failure would reasonably be expected to cause severe personal injury or death.