

## Wideband Power Amplifier 20GHz-54GHz



### Product Description

RP20G54GSPA is a wideband power amplifier with a frequency range of 20 to 54GHz.

The power output of this amplifier is 29dBm typical. The typical small signal gain is 16dB with a variance of  $\pm 3$ dB. This excellent performance is achieved through the use of GaN devices.

The power amplifier's input and output connectors are 2.4mm.

The operating temperature of this product is within -40 to +85°C.

### Features

- Wideband Solid State Power Amplifier
- Small Signal Gain 16dB Typical
- Output Saturation Power 29dBm Typical
- Supply Voltage +5VDC
- 50 Ohm Matched Input/Output
- Drain Overvoltage Protection
- Drain Overcurrent Protection

### Typical Applications

- Wireless Infrastructure
- Military and Aerospace Applications
- Test Instrumentation
- Radar Systems
- 5G Wireless Communications
- Microwave Radio Systems
- TR Modules
- Research and Development
- Cellular Base Stations

### Electrical Specifications ( $T_A = +25^\circ\text{C}$ )

Parameter	Min	Typ	Max	Min	Typ	Max	Units
Frequency Range		20 – 40			40 – 54		GHz
Small Signal Gain		16			15		dB
Gain Variance		+/-3			+/-3		dB
Gain Variation Over Temperature (-40°C to +70°C)		+/-3			+/-3		dB
Input Return Loss		-15			-15		dB
*Output 1dB Compression Point (P1dB)		29			27		dBm
*Saturated Output Power (Psat)		30			28		dBm
Supply Current (Vcc = +5VDC)		1.6	2.1		1.6	2.3	A
IM3		-30			-30		dBc
Weight				0.2			lbs.
Impedance				50			Ohms
Input / Output Connectors				2.4mm Female			
Package	Epoxy Sealed (Standard)						
	Hermetically Sealed (Optional)						

Note: Special screening is available with extra cost. Please inquire with sales.

**Absolute Maximum Ratings**

Parameter	Rating
Supply Voltage Range	+5.5VDC
*RF Input Power (RFIN)	Psat – Large Signal Gain

**Bias Up Procedure**

1. Connect ground
2. Connect input and output with 50 Ohm source/load.  
(In band VSWR < 1.9:1 or >10dB return loss.)
3. Connect positive supply and make sure power supply can handle max current.

**Bias Down Procedure**

1. Turn off power supply
2. Remove positive supply Connection
3. Remove RF Connection
4. Remove ground

**Environmental Specifications and Test Standards**

Parameter	Description
Operational Temperature	-40°C to +75°C (Case Temperature)
Storage Temperature	-55°C to +125°C
Thermal Shock	-40°C → +85°C (5 Cycles / 10 hours)
**Random Vibration	MIL-STD-202G Table 214-I, Test Condition Letter C 1.5 Hours Per Axis
High Temperature Burn In	Temperature +85°C for 72 Hours
Shock	1. Weight >20g, 50g half sine wave for 11ms, Speed variation 3.44m/s 2. Weight <=20g, 100g Half sine wave for 6ms, Speed variation 3.75m/s 3. Total 18 times (6 directions, 3 repetitions per direction).
Altitude	Standard: 30,000 Ft (Epoxy Sealed Controlled Environment) Optional: Hermetically Sealed (60,000 ft. 1.0 PSI min)
Hermetically Sealed (Optional)	MIL-STD-883 (For Hermetically Sealed Units)

Notes:

- Maximum RF input power is set to assure safety of amplifier. Input power may be increased at own risk to achieve full power of amplifier. Please reference gain and power curves.
- For vibration testing details please see additional information section

Typical Performance Plots

Input Return Loss vs Frequency @+25°C

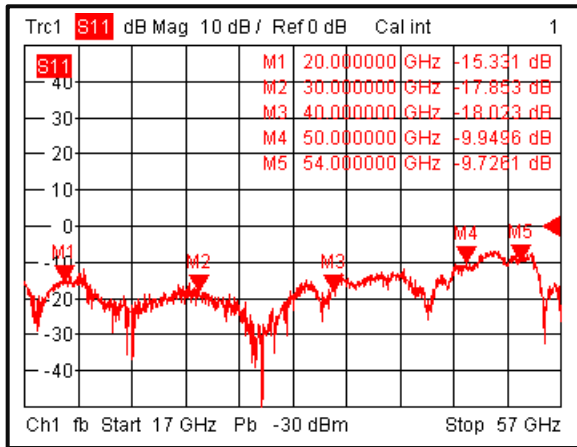

Gain vs Frequency @+25°C

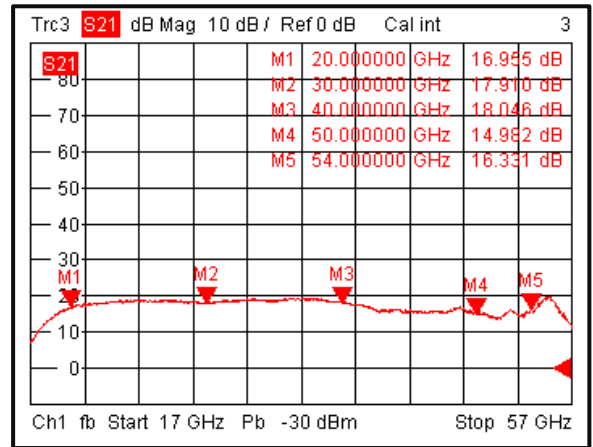

Output Return Loss vs Frequency @+25°C

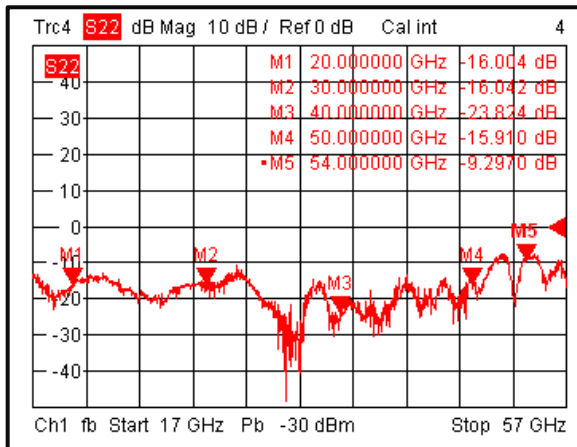

Isolation vs Frequency @+25°C

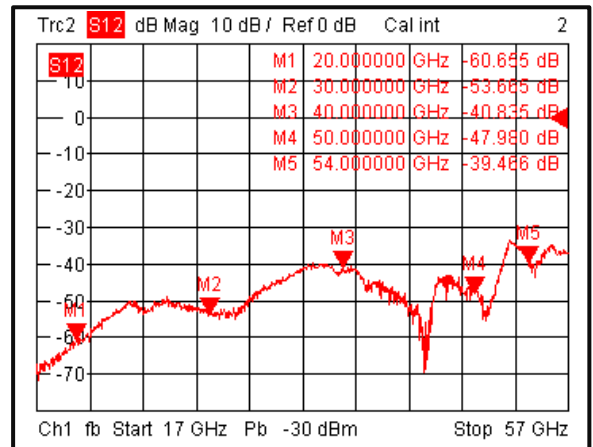

Note: Small signal VNA measurements include attenuators to protect equipment

Typical Performance Plots

Gain vs Output Power CW

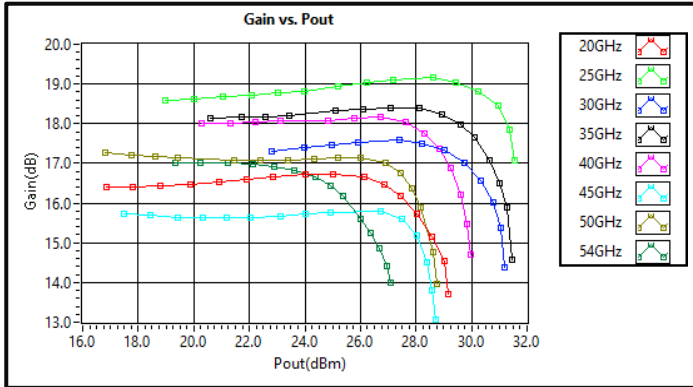

Gain vs Output Power \*Pulse

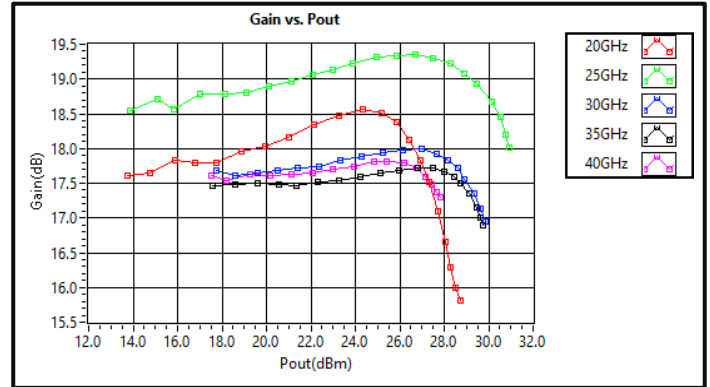

Output vs Input Power CW

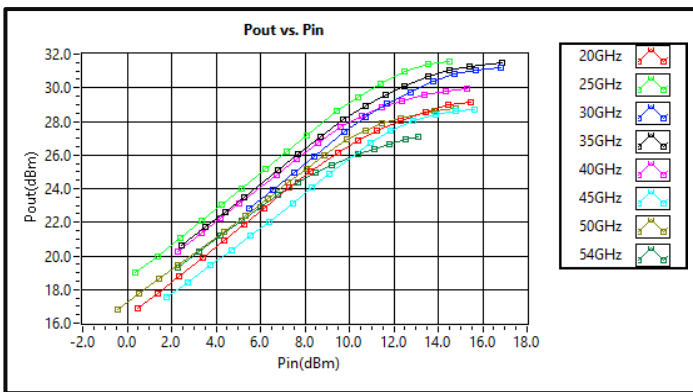

Output vs Input Power \*Pulse

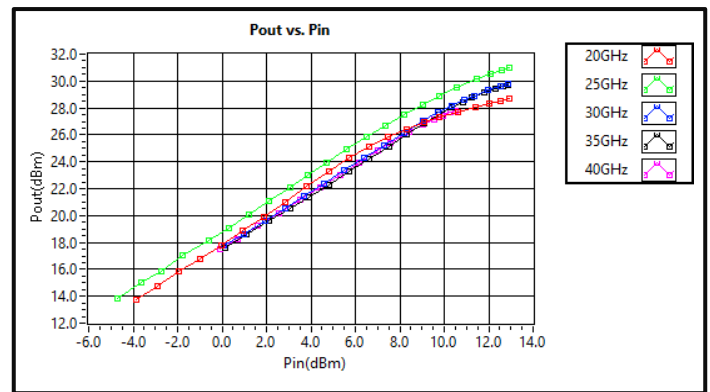

PxdB vs Frequency CW

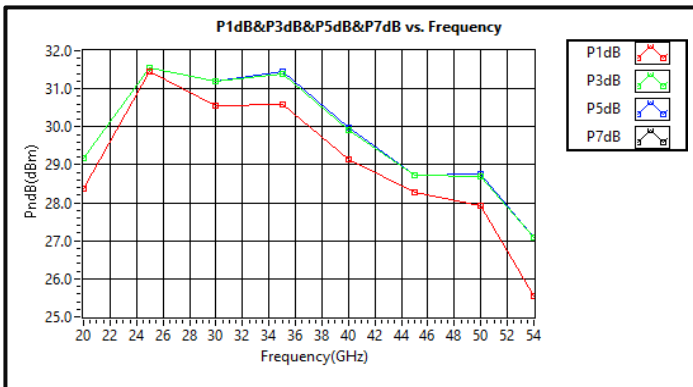

PxdB vs Frequency \*Pulse

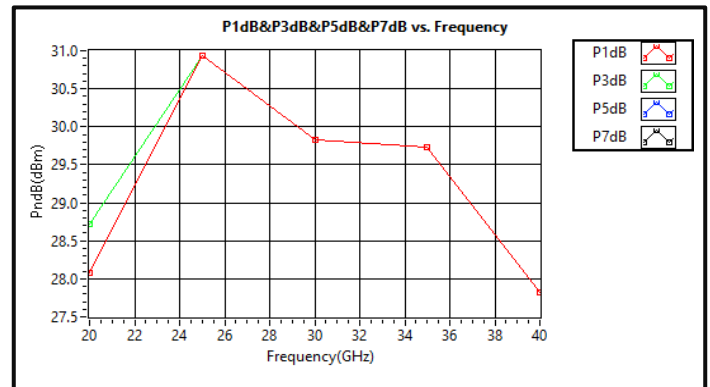

\*Pulse Psat power test signal: 200μs pulse width with 10% duty cycle.

Typical Performance Plots

Left IM3 vs Output Power

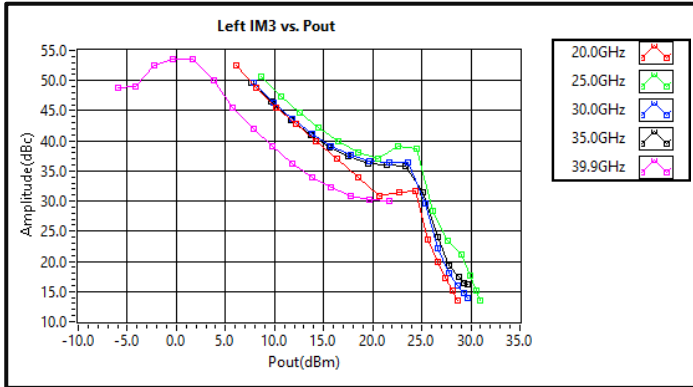

Right IM3 vs Output Power

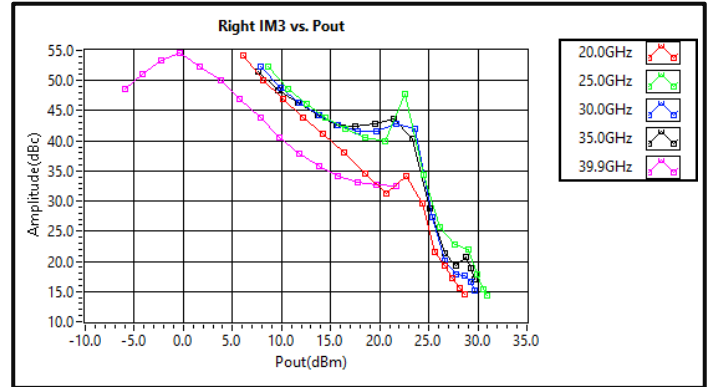

Delta IM3 vs Output Power

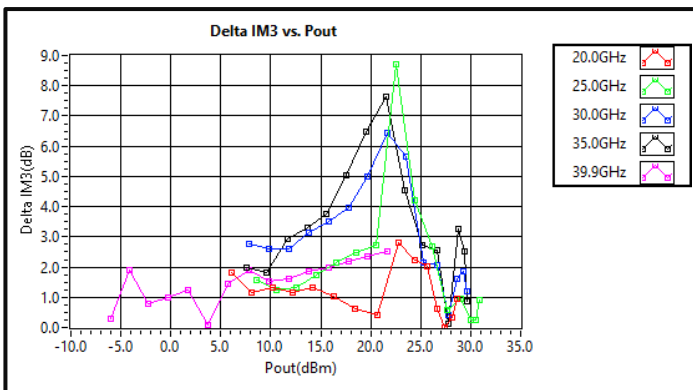

Current vs Output Power (+5VDC)

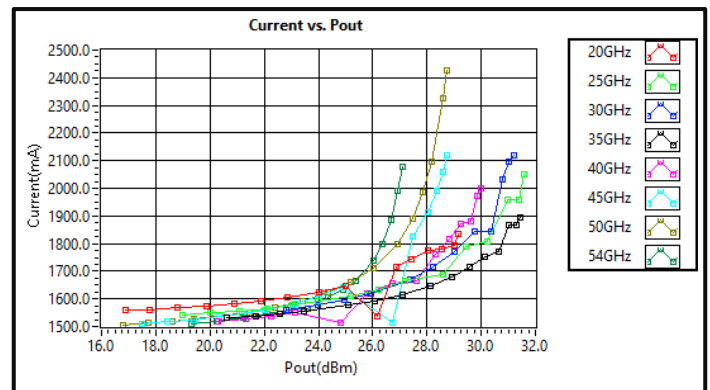

Note: IM3 test performed with 1MHz tone spacing

**Outline Drawing**

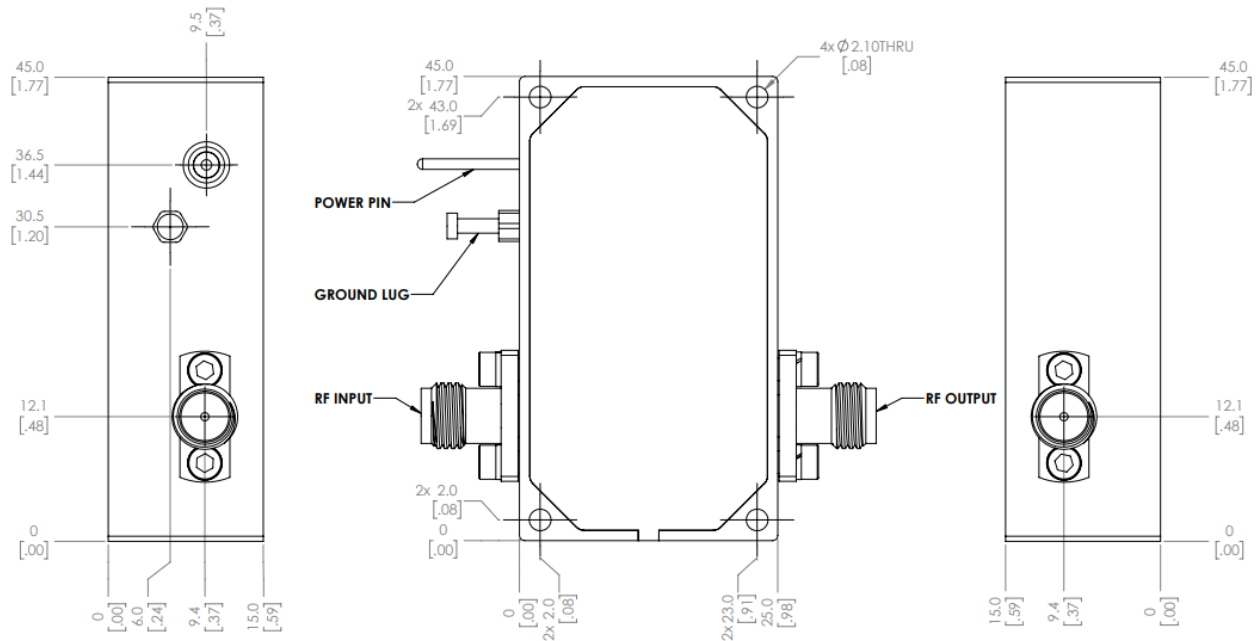

**Notes:**

1. Package Material: Aluminum and Copper
2. Plating: Nickel
3. All dimensions are in millimeters [inches].
4. Tolerances  $\pm 0.25$  [0.010] unless otherwise specified.
5. Heat sink required during operation (sold separately). Matching heatsink is listed on our website. If customer would like to use their own cooling method, please make sure the amplifier will operate under the specs that listed in page 2 of this datasheet.

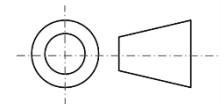

**Additional Information**

Documentation	Webpage
ESD Policy	<a href="https://rflambda.com/pdf/rflambda_esd_control.pdf">https://rflambda.com/pdf/rflambda_esd_control.pdf</a>
Heatsink Lookup Specifications	<a href="https://rflambda.com/search_heatsink.jsp">https://rflambda.com/search_heatsink.jsp</a>
Connector Torque Specifications	<a href="https://www.rflambda.com/pdf/Torque_Specifications.pdf">https://www.rflambda.com/pdf/Torque_Specifications.pdf</a>
Random Vibration Test Standard	<a href="https://www.rflambda.com/pdf/rflambda_random_vibration_MIL-STD-202G.pdf">https://www.rflambda.com/pdf/rflambda_random_vibration_MIL-STD-202G.pdf</a>

**Ordering Information**

Part Number	Modification	Description
RP20G54GSPA	Input connector 2.4mm	20GHz-54GHz Power Amplifier

**Amplifier Use**

Ensure that the amplifier input and output ports are safely terminated into a proper 50 ohm load before turning on the power. Never operate the amplifier without a load. A proper 50 ohm load is defined as a load with impedance less than 1.9:1 or return loss larger than 10dB relative to 50 Ohm within the specified operating band width.

Power Supply Requirements

Power supply must be able to provide adequate current for the amplifier. Power supply should be able to provide 1.5 times the typical current or 1.2 times the maximum current (whichever is greater).

In most cases, RF - Lambda amplifiers will withstand severe mismatches without damage. However, operation with poor loads is discouraged. If prolonged operation with poor or unknown loads is expected, an external device such as an isolator or circulator should be used to protect the amplifier.

Ensure that the power is off when connecting or disconnecting the input or output of the amp.

Prevent overdriving the amplifier. Do not exceed the recommended input power level.

Adequate heat-sinking required for RF amplifier modules. Please inquire.

Amplifiers do not contain Thermal protection, Reverse DC polarity or Over voltage protection with the exception of a few models. Please inquire.

Proper electrostatic discharge (ESD) precautions are recommended to avoid performance degradation or loss of functionality.

What is not covered with warranty?

Each RF - Lambda amplifier will go through power and temperature stress testing. Since the die, ICs or MMICs are fragile, these are not covered by warranty. Any damage to these will NOT be free to repair.

**Important Notice**

The information contained herein is believed to be reliable. RF-Lambda makes no warranties regarding the information contained herein. RF-Lambda assumes no responsibility or liability whatsoever for any of the information contained herein. RF-Lambda assumes no responsibility or liability whatsoever for the use of the information contained herein. The information contained herein is provided "AS IS, WHERE IS" and with all faults, and the entire risk associated with such information is entirely with the user. All information contained herein is subject to change without notice. Customers should obtain and verify the latest relevant information before placing orders for RF-Lambda products. The information contained herein or any use of such information does not grant, explicitly or implicitly, to any party any patent rights, licenses, or any other intellectual property rights, whether with regard to such information itself or anything described by such information. RF-Lambda products are not warranted or authorized for use as critical components in medical, life-saving, or life sustaining applications, or other applications where a failure would reasonably be expected to cause severe personal injury or death.