

Wide Band Power Amplifier 6GHz-12GHz



Product Description

RFLUPA06G12GA is a wideband power amplifier with a frequency range of 6 to 12GHz.

The power output of this amplifier is 30dBm typical. The typical gain is 24dB with a flatness of ± 2.0 dB. This power amplifier works with a +24VDC power supply.

The working temperature of this product is between - 40°C and + 85°C.

Features

- Wideband Power Amplifier
- Gain 24dB Typical
- Output Saturation Power 30dBm Typical
- Supply Voltage +24VDC
- 50 Ohm Matched

Typical Applications

- Wireless Infrastructure
- Military and Aerospace Applications
- Test Instrumentation
- Radar Systems
- 5G Wireless Communications
- Microwave Radio Systems
- TR Modules
- Research and Development
- Cellular Base Stations

Electrical Specifications ($T_A=+25^\circ\text{C}$), $V_{CC}=+24\text{VDC}$

Parameter	Min	Typ	Max	Units
Frequency Range	6		12	GHz
Gain	19	24		dB
Gain Flatness		± 2.0	± 3.0	dB
Gain Variation Over Temperature (-40°C to +85°C)		± 1.0		dB
Input VSWR		1.8	2.2	:1
Output VSWR		1.8	2.2	:1
Output 1dB Compression Point (P1dB)	26	27		dBm
Saturated Output Power (Psat)		30		dBm
Supply Current ($V_{CC} = +24\text{VDC}$)		150	300	mA
Efficiency at P1dB		25		%
Isolation S12		-40		dB
Weight		0.055 Max.		lbs.
Impedance		50		Ohms
Input / Output Connectors	SMA- Female			
Package	Epoxy Sealed (Standard)			
	Hermetically Sealed (Optional)			

Absolute Maximum Ratings

Parameter	Rating
Operating Voltage	+25V
*RF Input Power (RFIN)	+30dBm

Bias Up Procedure

- 1.Connect Ground Pin
- 2.Connect input and output
- 3.Connect +28V biasing

Bias Down Procedure

- 1.Turn off +28V biasing
- 2.Remove RF connection
- 3.Remove Ground.

Environmental Specifications and Test Standards

Parameter	Description
Operational Temperature	-40°C to +85°C (Case Temperature)
Storage Temperature	-50°C to +105°C
Thermal Shock	-40°C → +85°C (5 Cycles / 10 hours)
**Random Vibration	MIL-STD-202G Table 214-I, Test Condition Letter C 1.5 Hours Per Axis
High Temperature Burn In	Temperature +85°C for 72 Hours
Shock	1. Weight >20g, 50g half sine wave for 11ms, Speed variation 3.44m/s 2. Weight <=20g, 100g Half sine wave for 6ms, Speed variation 3.75m/s 3. Total 18 times (6 directions, 3 repetitions per direction).
Altitude	Standard: 30,000 Ft (Epoxy Sealed Controlled Environment) Optional: Hermetically Sealed (60,000 ft. 1.0 PSI min)
Hermetically Sealed (Optional)	MIL-STD-883 (For Hermetically Sealed Units)

*Maximum RF input power is set to assure safety of amplifier. Input power may be increased at own risk to achieve full power of amplifier. Please reference gain and power curves.

**For vibration testing details please see additional information section.

Typical Performance Plots

Gain @ +25°C

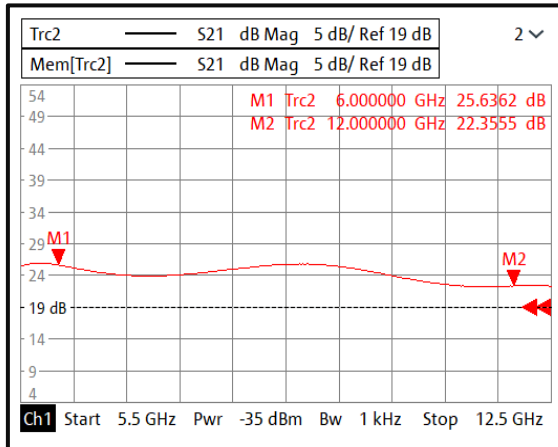

Input VSWR @+25°C

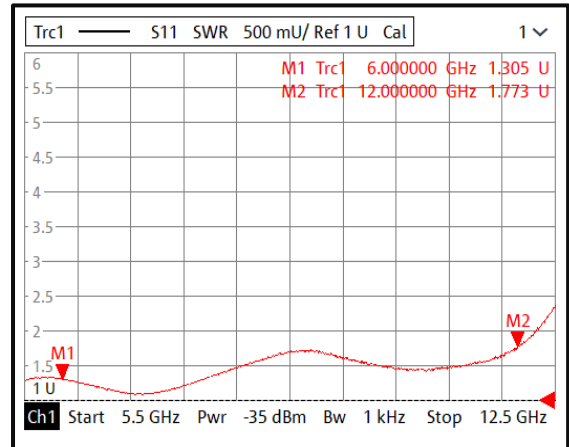

Output VSWR @+25°C

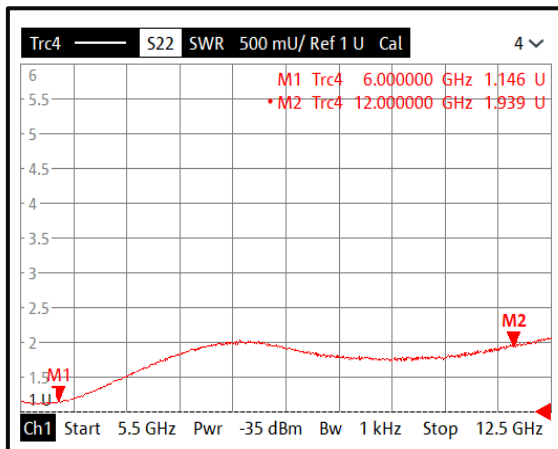

Isolation @ +25°C

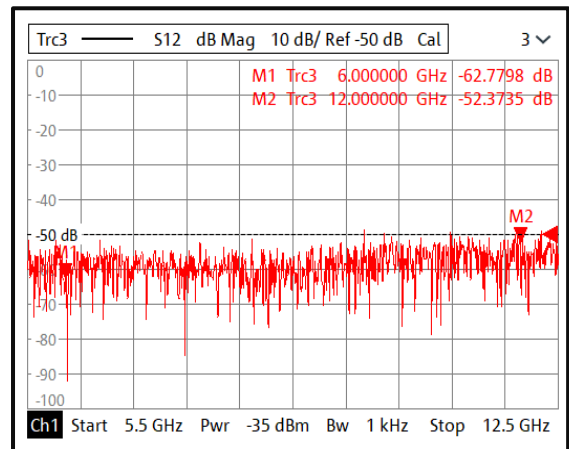

Gain @ -40°C

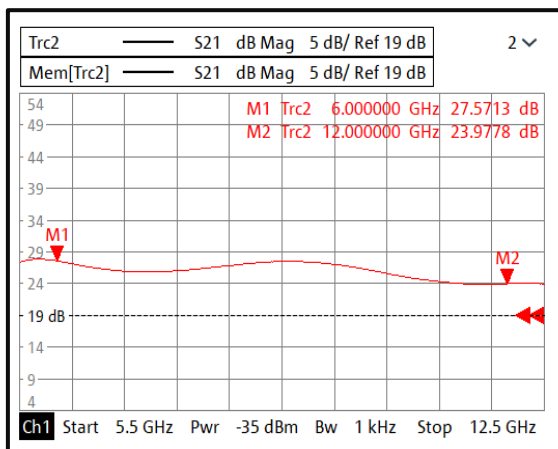

Input VSWR @ -40°C

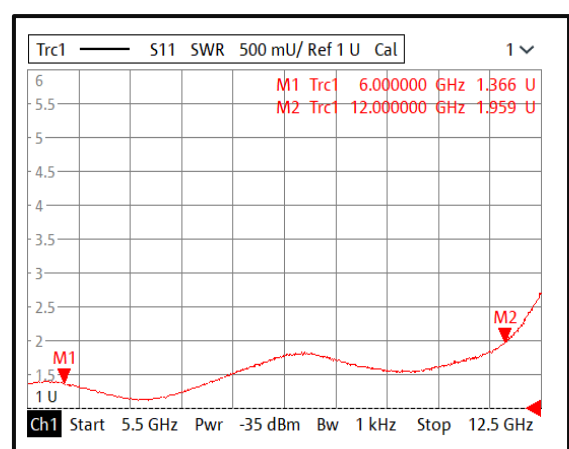

Typical Performance Plots

Isolation@-40°C

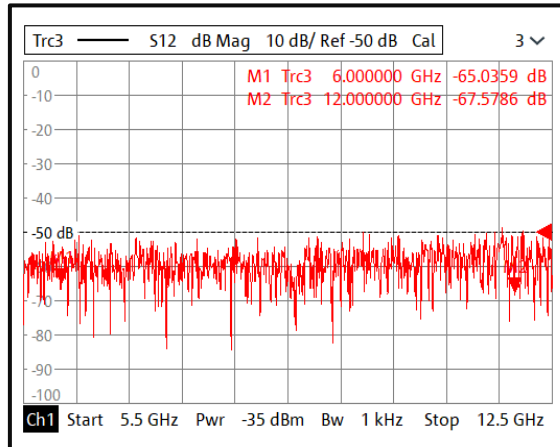

Gain @ +85°C

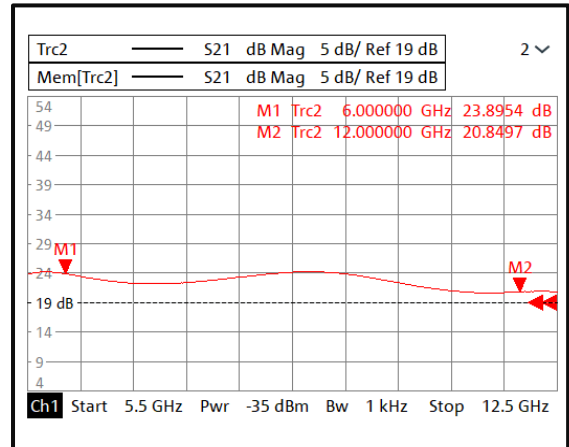

Input VSWR @ +85°C

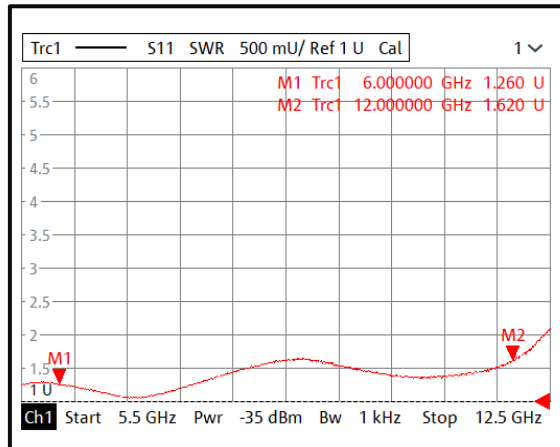

Isolation @ +85°C

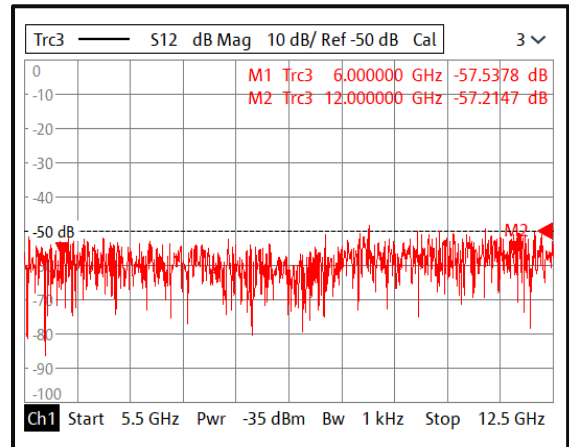

Note: Small signal VNA measurements include attenuators to protect equipment

Typical Performance Plots

Gain vs. Output Power

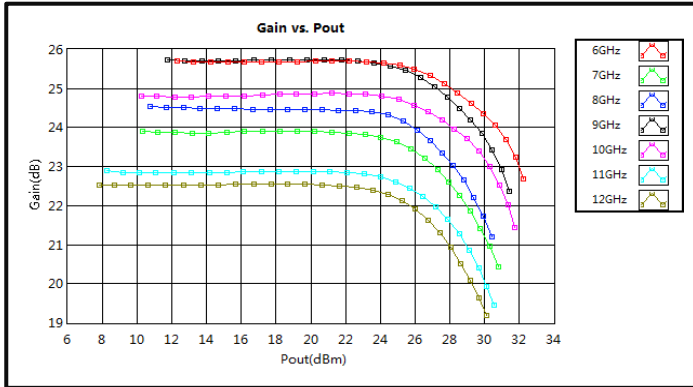

PndB vs. Frequency

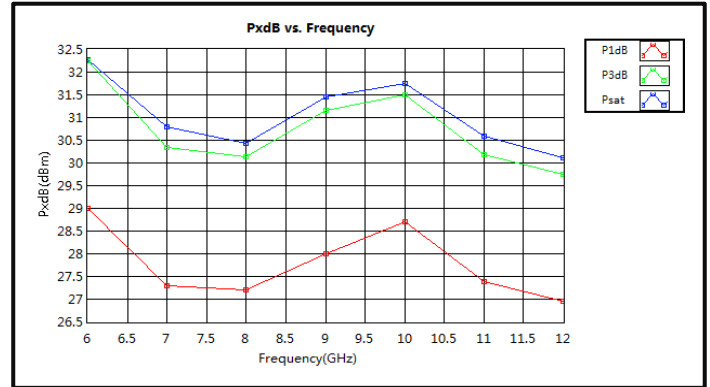

Power Added Efficiency

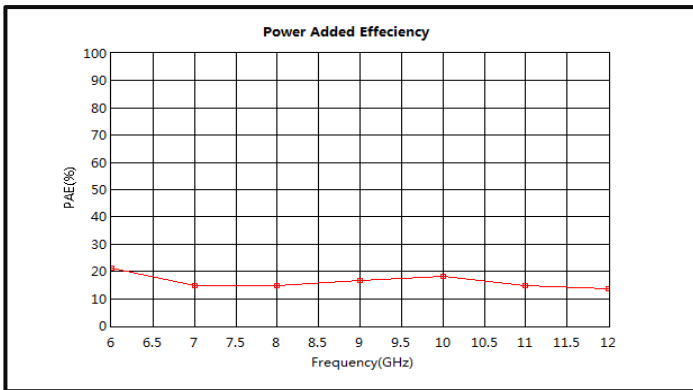

Saturation Power vs. Frequency

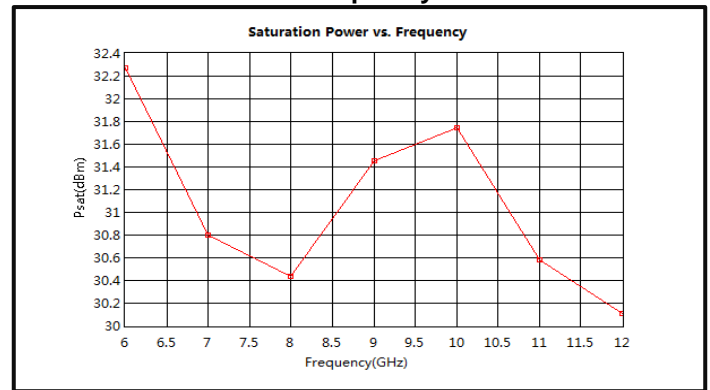

Pout vs. Pin

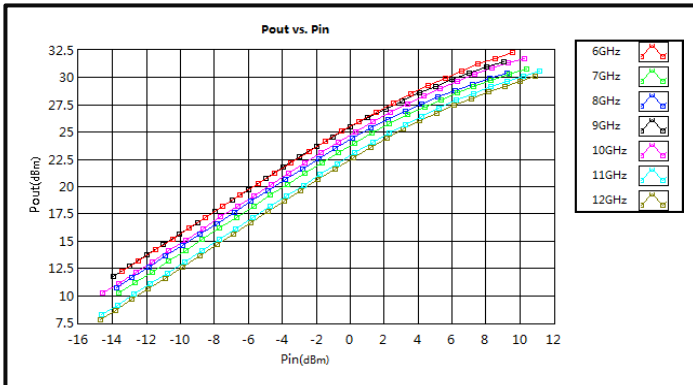

Current vs. Pout

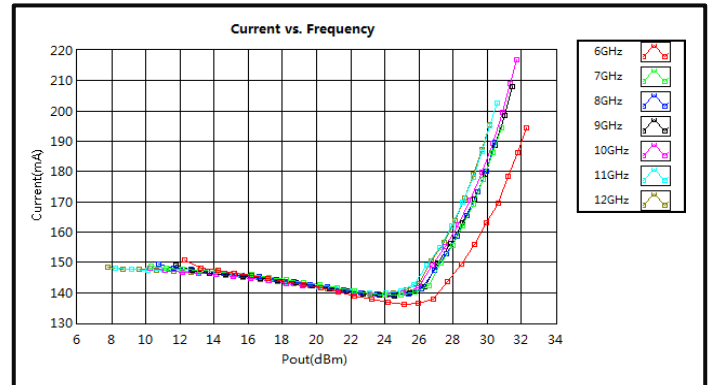

Typical Performance Plots

Left IM3 vs. Pout

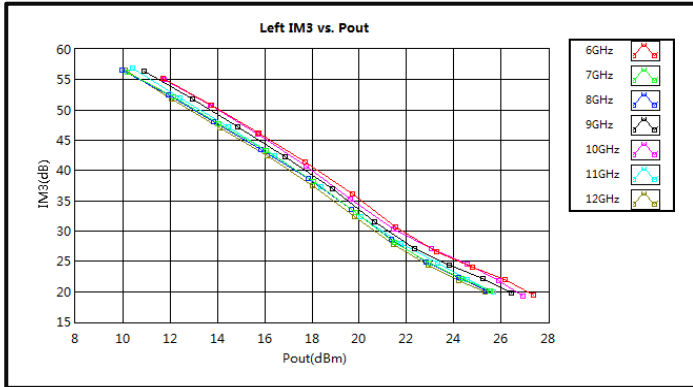

Right IM3 vs. Pout

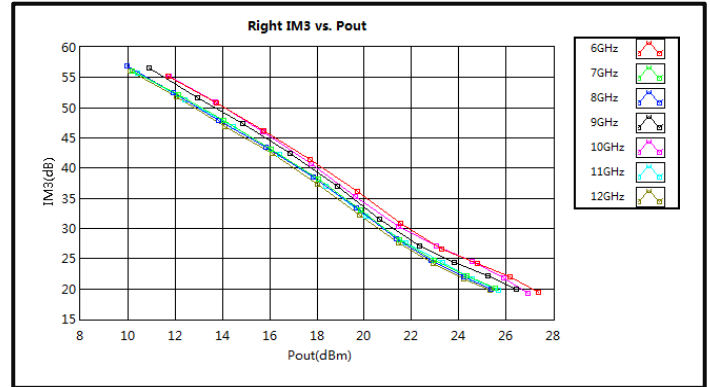

Delta IM3 vs. Pout

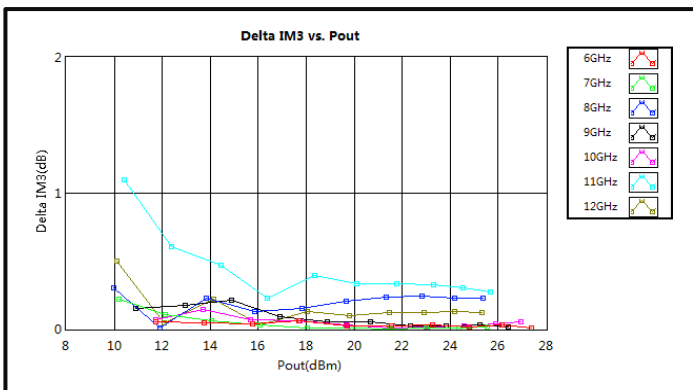

2nd Harmonic Wave Output Power

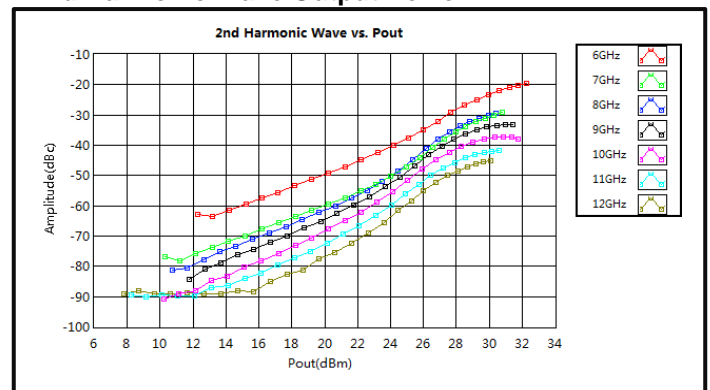

3rd Harmonic Wave Output Power

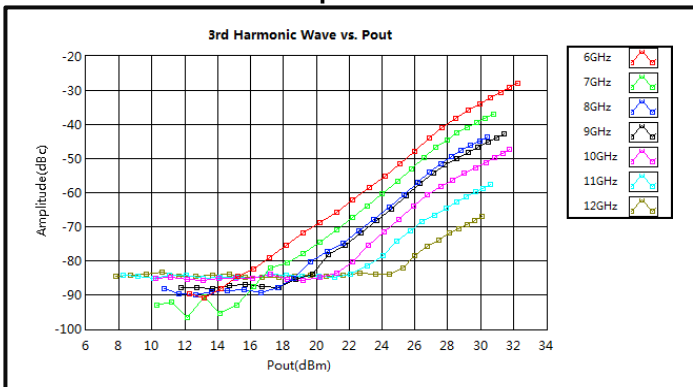

4th Harmonic Wave Output Power

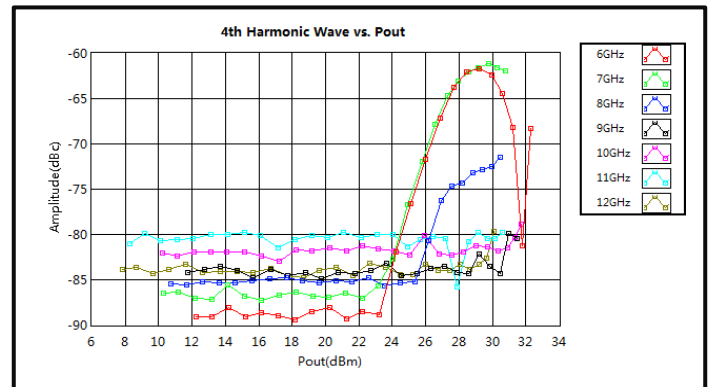

Note: IM3 test performed with 1MHz tone spacing

Outline Drawing

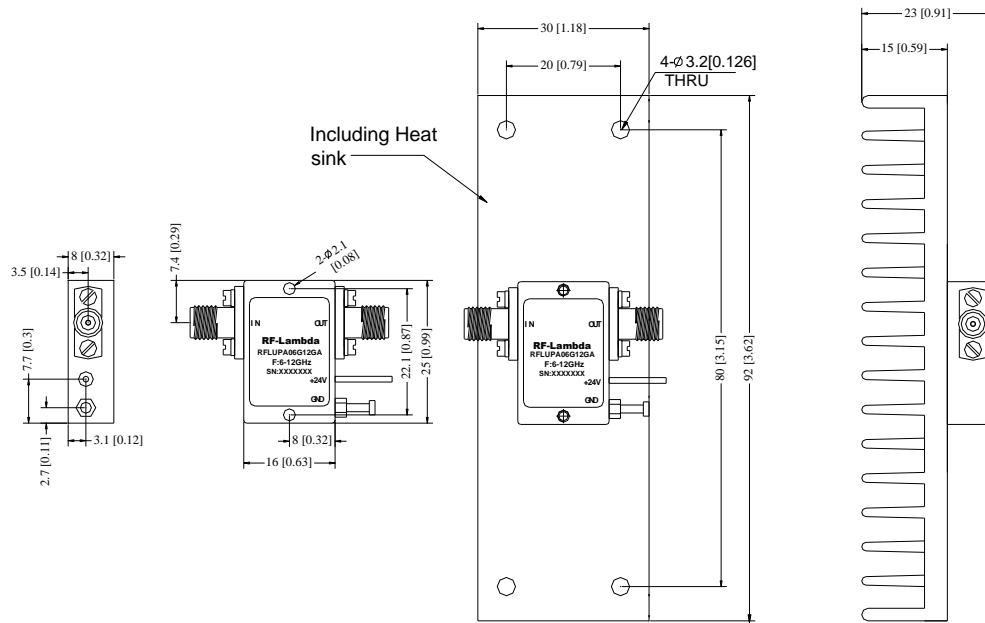

Notes:

1. Package Material: Aluminum
2. Finish: Standard: Gold 40 micron; Nickel 220 micron thickness. Option: Gold 80 micron; Nickel 180 micron thickness
3. All dimensions are in millimeters [inches].
4. Heat sink required during operation (sold separately). Matching heatsink is listed on our website. If customer would like to use their own cooling method, please make sure the amplifier will operate under the specs that listed in page 2 of this datasheet.
5. Standard torque wrench must be used to secure RF connectors.

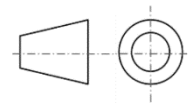

Additional Information

Documentation	Webpage
ESD Policy	https://rflambda.com/pdf/rflambda_esd_control.pdf
Heatsink Lookup Specifications	https://rflambda.com/search_heatsink.jsp
Connector Torque Specifications	https://www.rflambda.com/pdf/Torque_Specifications.pdf
Random Vibration Test Standard	https://www.rflambda.com/pdf/rflambda_random_vibration_MIL-STD-202G.pdf

Ordering Information

Part Number	Modification	Description
RFLUPA06G12GA	Standard	6GHz-12GHz Wide Band Power Amplifier

Amplifier Use

Ensure that the amplifier input and output ports are safely terminated into a proper 50 ohm load before turning on the power. Never operate the amplifier without a load. A proper 50 ohm load is defined as a load with impedance less than 1.9:1 or return loss larger than 10dB relative to 50 Ohm within the specified operating band width.

Power Supply Requirements

Power supply must be able to provide adequate current for the amplifier. Power supply should be able to provide 1.5 times the typical current or 1.2 times the maximum current (whichever is greater).

In most cases, RF - Lambda amplifiers will withstand severe mismatches without damage. However, operation with poor loads is discouraged. If prolonged operation with poor or unknown loads is expected, an external device such as an isolator or circulator should be used to protect the amplifier.

Ensure that the power is off when connecting or disconnecting the input or output of the amp.

Prevent overdriving the amplifier. Do not exceed the recommended input power level.

Adequate heat-sinking required for RF amplifier modules. Please inquire.

Amplifiers do not contain Thermal protection, Reverse DC polarity or Over voltage protection with the exception of a few models. Please inquire.

Proper electrostatic discharge (ESD) precautions are recommended to avoid performance degradation or loss of functionality.

What is not covered with warranty?

Each RF - Lambda amplifier will go through power and temperature stress testing.

Since the die, ICs or MMICs are fragile, these are not covered by warranty. Any damage to these will NOT be free to repair.

Important Notice

The information contained herein is believed to be reliable. RF-Lambda makes no warranties regarding the information contained herein. RF-Lambda assumes no responsibility or liability whatsoever for any of the information contained herein. RF-Lambda assumes no responsibility or liability whatsoever for the use of the information contained herein. The information contained herein is provided "AS IS, WHERE IS" and with all faults, and the entire risk associated with such information is entirely with the user. All information contained herein is subject to change without notice. Customers should obtain and verify the latest relevant information before placing orders for RF-Lambda products. The information contained herein or any use of such information does not grant, explicitly or implicitly, to any party any patent rights, licenses, or any other intellectual property rights, whether with regard to such information itself or anything described by such information.

RF-Lambda products are not warranted or authorized for use as critical components in medical, life-saving, or life sustaining applications, or other applications where a failure would reasonably be expected to cause severe personal injury or death.