



30W 2-6GHz Laser sealed DB9 Port Controlled Wide Band PA



Features

- Wideband Solid State Power Amplifier
- Gain: 50dB Typical
- Psat: +44 dBm Typical
- Supply Voltage: +28V

Typical Applications

- Military & Defense Applications
- Wireless Infrastructure
- Test and Measurement

Electrical Specifications, $T_A = +25^\circ\text{C}$, $V_{CC} = +28\text{V}$

Parameter	Min	Typ	Max	Units
Frequency Range		2-6		GHz
Gain		50		dB
Gain Flatness		±5		dB
Gain Variation Over Temperature (-45 ~ +85)		±3		dB
Input Return Loss		15		dB
Output Return Loss		20		dB
Output 1dB Compression Point (P1dB)		37		dBm
Saturated Output Power (Psat)		43-5		dBm
Supply Current		600	3500	mA
Isolation S12		60		dB
Input Max Power (No damage)		Psat – Gain		dBm
Weight		800		g
Impedance		50		Ohms
Input / Output Connectors		SMA-Female		
Finish		Nickel Plated		
Material		Aluminum / Copper		

* P1dB, P3dB and Psat power test signal: 200µs pulse width with 10% duty cycle.

* For average CW power testing or increased duty cycle, a 5dB back off from Psat is required unless water/oil cooling system is applied.

30W 2-6GHz Laser sealed DB9 Port Controlled Wide Band PA



RF-LAMBDA

The power beyond expectations

RFLUPA02G06GNL

Absolute Maximum Ratings	
Supply Voltage	+36 VDC
RF Input Power	Psat – Gain

Note: Maximum RF input power is set to assure safety of amplifier. Input power may be increased at own risk to achieve full power of amplifier. Please reference gain and power curves.

Biasing Up Procedure	
Step 1	Connect input and output with 50 Ohm source/load. (in band VSWR<1.9:1 or >10dB return loss)
Step 2	Connect Ground
Step 3	Connect VDC
Power OFF Procedure	
Step 1	Turn Off VDC
Step 2	Remove RF Connection
Step 3	Remove Ground

Environmental Specifications and Test Standards

Parameter	Standard	Description
Operational Temperature	MIL-STD-39016	-45°C~+55°C (Case Temperature less than 85C)
Storage Temperature		-50°C~+125°C
Thermal Shock		1 Hour@ -45°C → 1 Hour @ +85°C (5 Cycles)
Random Vibration		Acceleration Spectral Density 6 (m/s) Total 92.6 RMS
Electrical & Temperature Burn In		Temperature +85°C for 72 Hours
Shock		1. Weight >20g, 50g half sine wave for 11ms, Speed variation 3.44m/s 2. Weight <=20g, 100g Half sine wave for 6ms, Speed variation 3.75m/s 3. Total 18 times (6 directions, 3 repetitions per direction).
Altitude		Sealed (60,000 ft. 1.0 PSI min)
Environmentally Sealed (Optional)	MIL-STD-880G	MIL-STD-880G (For Environmentally Sealed Units)

Note: The operating temperature for the unit is specified at the package base. It is the user's responsibility to ensure the part is in an environment capable of maintaining the temperature within the specified limits

30W 2-6GHz Laser Sealed DB9 Port Controlled Wide Band PA



Ordering Information	
Part No.	Description
RFLUPA02G06GNL	2GHz~6GHz Power Amplifier

Amplifier Use

Ensure that the amplifier input and output ports are safely terminated into a proper 50 ohm load before turning on the power. Never operate the amplifier without a load. A proper 50 ohm load is defined as a load with impedance less than 1.9:1 or return loss larger than 10dB relative to 50 Ohm within the specified operating band width.

Power Supply Requirements

Power supply must be able to provide adequate current for the amplifier. Power supply should be able to provide 1.5 times the typical current or 1.2 times the maximum current (whichever is greater).

In most cases, RF - Lambda amplifiers will withstand severe mismatches without damage. However, operation with poor loads is discouraged. If prolonged operation with poor or unknown loads is expected, an external device such as an isolator or circulator should be used to protect the amplifier.

Ensure that the power is off when connecting or disconnecting the input or output of the amp.

Prevent overdriving the amplifier. Do not exceed the recommended input power level.

Adequate heat-sinking required for RF amplifier modules. Please inquire.

Amplifiers do not contain Thermal protection, Reverse DC polarity or Over voltage protection with the exception of a few models. Please inquire.

Proper electrostatic discharge (ESD) precautions are recommended to avoid performance degradation or loss of functionality.

What is not covered with warranty?

Each RF - Lambda amplifier will go through power and temperature stress testing. Since the die, ICs or MMICs are fragile, these are not covered by warranty. Any damage to these will NOT be free to repair.



Gain vs. Frequency

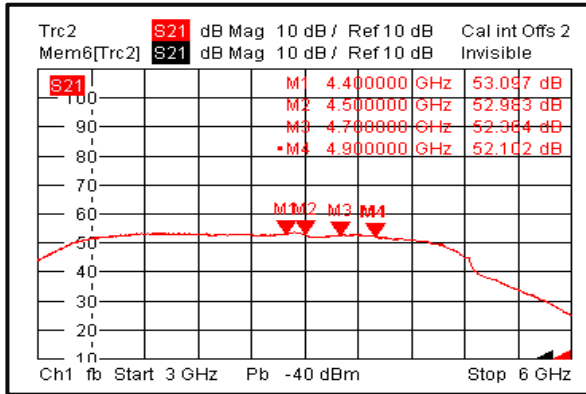

Isolation

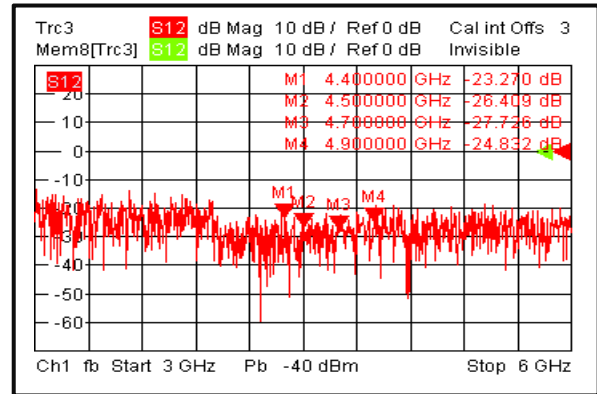

Input Return Loss

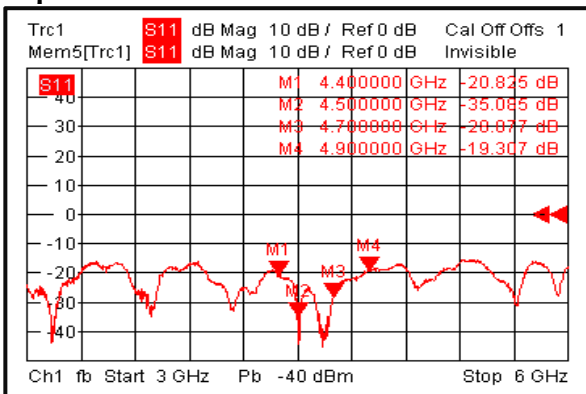

Output Return Loss

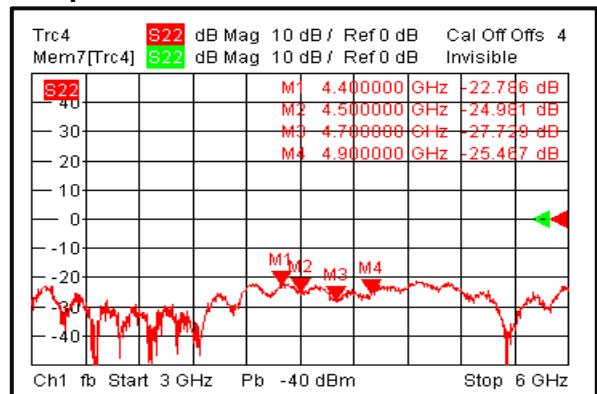

Note: Input / Output return loss measurements include attenuators to protect equipment

30W 2-6GHz Laser Sealed DB9 Port Controlled Wide Band PA



RF-LAMBDA

The power beyond expectations

RFLUPA02G06GNL

Gain vs. Output Power

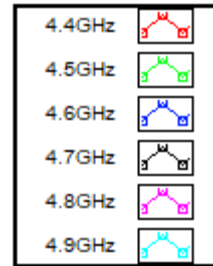
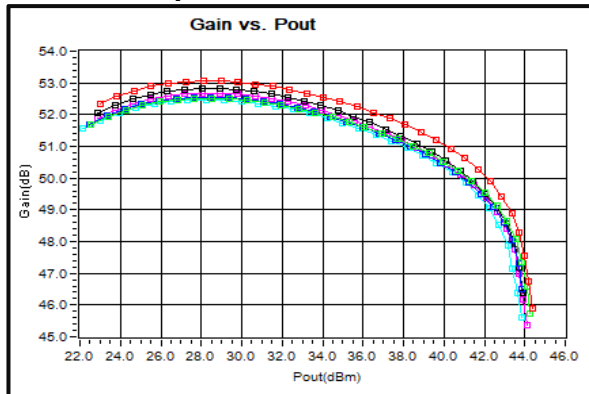

Current vs. Output Power

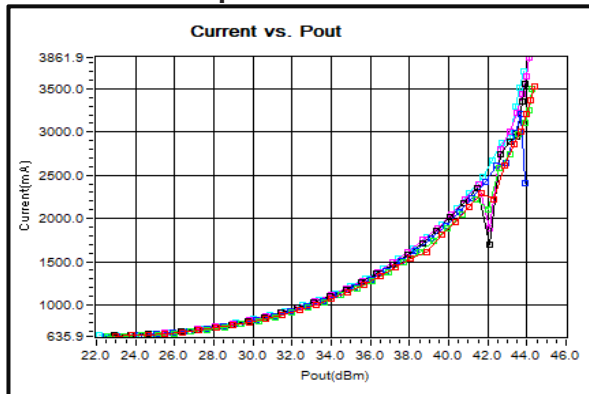

PSat vs. Frequency

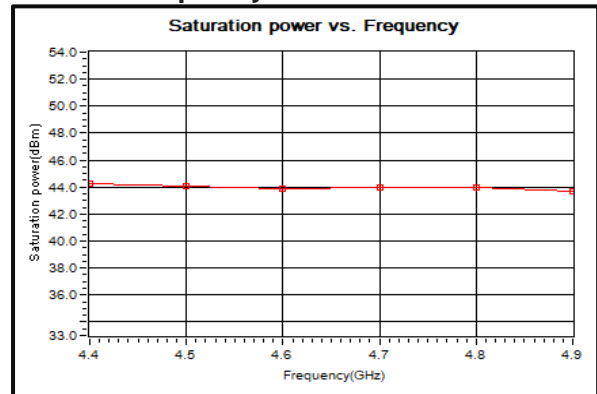

30W 2-6GHz Laser Sealed DB9 Port Controlled Wide Band PA



2nd Harmonic (dBc) vs. Output Power

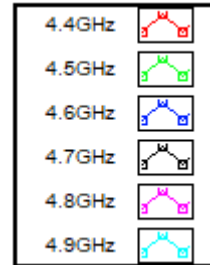
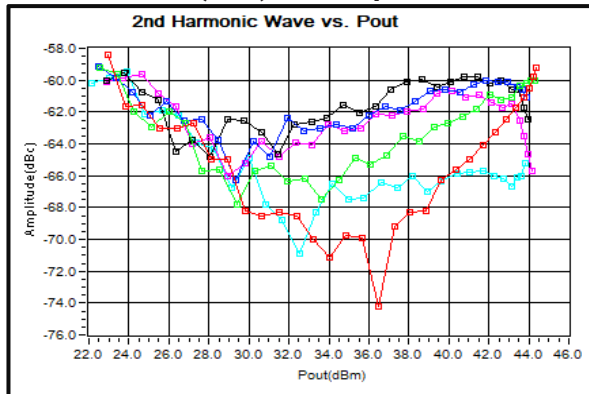

3rd Harmonic (dBc) vs. Output Power

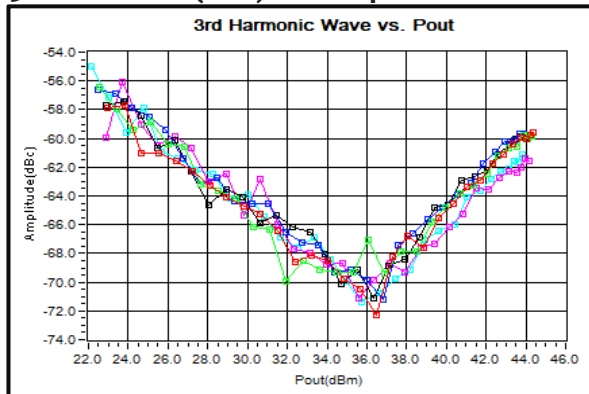

4th Harmonic (dBc) vs. Output Power

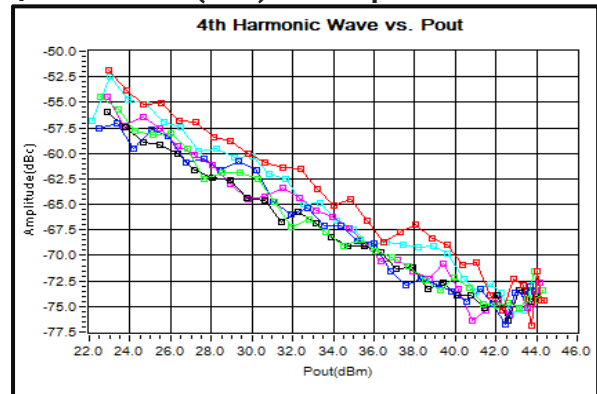

Left IM₃ (dBc) vs. Output Power

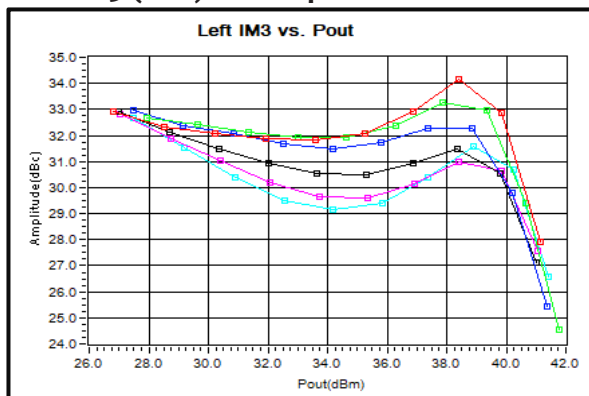

Right IM₃ (dBc) vs. Output Power

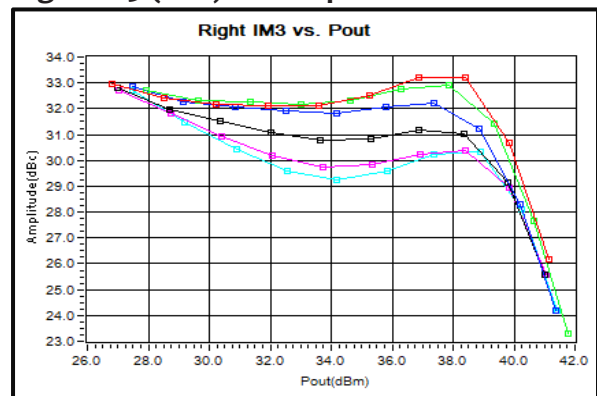

30W 2-6GHz Laser Sealed DB9 Port Controlled Wide Band PA



D-Sub 9 Pin

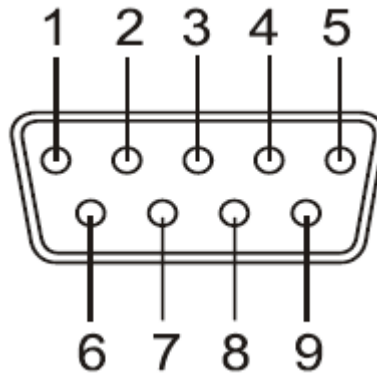

	Name	Function	Initial State	Description	Applied
Pin 1	NC	---	---	---	---
Pin 2	ID Over	Indicator	LOW	High TTL signal will indicate if the last stage of the amplifier is drawing too much current	Yes
Pin 3	ID Signal	Indicator	---	Analog voltage that represents the current being drawn from the last stage of the amplifier	Yes
Pin 4	VDC	---	---	VDC (must be able to support 5A) Both VDC pins must be tied together	Yes
Pin 5	VDC	---	---	VDC (must be able to support 5A) Both VDC pins must be tied together	Yes
Pin 6	RF Off	Control	LOW	Applying a TTL High signal to this pin will disable the RF signal	Yes
Pin 7	TEMP Signal	Indicator	---	Analog voltage that represents the case temperature of the amplifier	Yes
Pin 8	GND	---	---	GND (must be able to support 5A) Both GND pins must be tied together	Yes
Pin 9	GND	---	---	GND (must be able to support 5A) Both GND pins must be tied together	Yes

HIGH/LOW voltages are standard TTL signals:
 0.0V-0.8V = LOW
 2V-5V = HIGH

30W 2-6GHz Laser Sealed DB9 Port Controlled Wide Band PA



RF-LAMBDA

The power beyond expectations

RFLUPA02G06GNL

Outline Drawing:

All Dimensions in mm [inch]

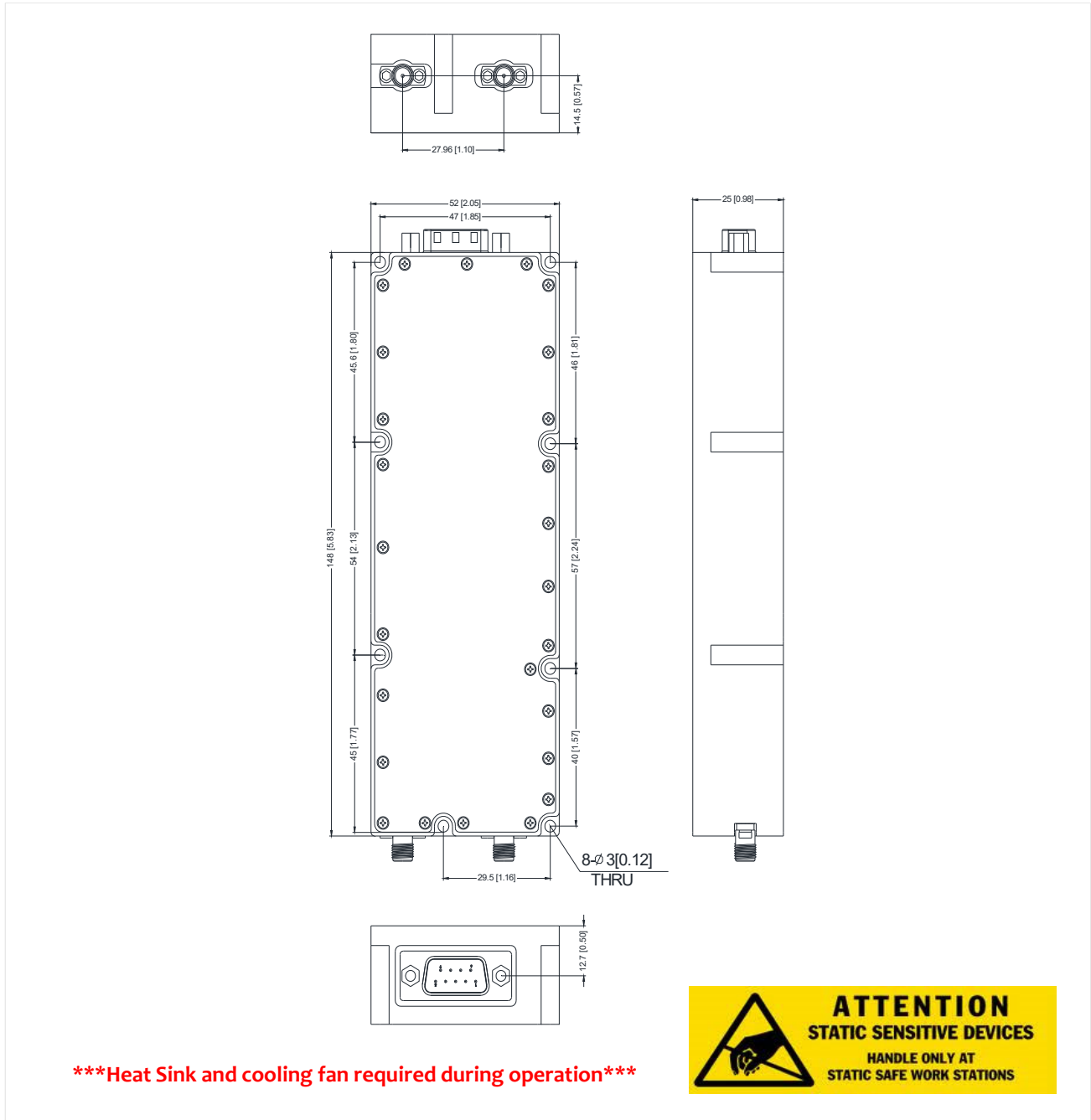

30W 2-6GHz Laser sealed DB9 Port Controlled Wide Band PA



Heatsink Outline Drawing:

All Dimensions in mm

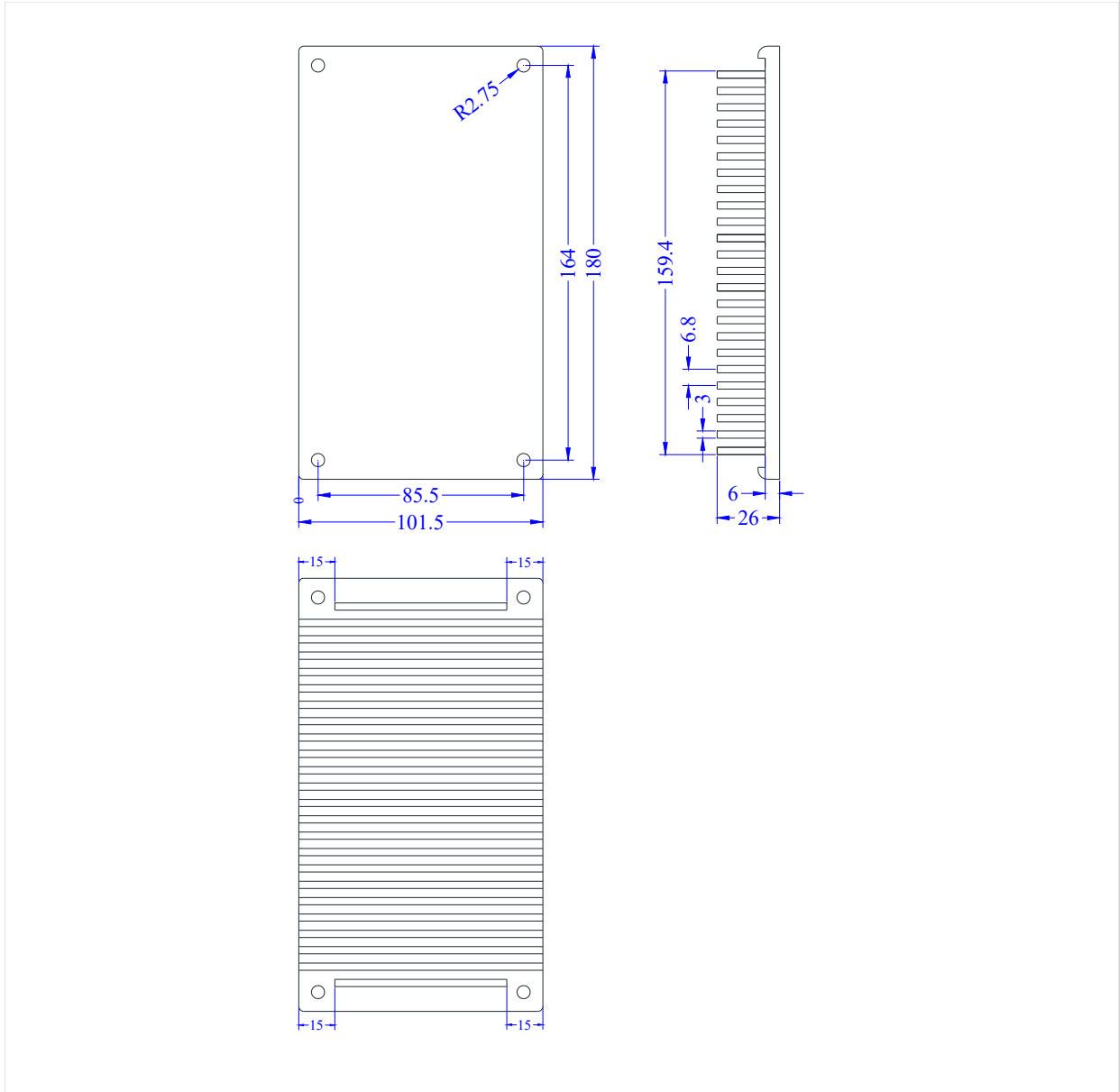

30W 2-6GHz Laser sealed DB9 Port Controlled Wide Band PA



Air Cooling Outline Drawing:

All Dimensions in mm

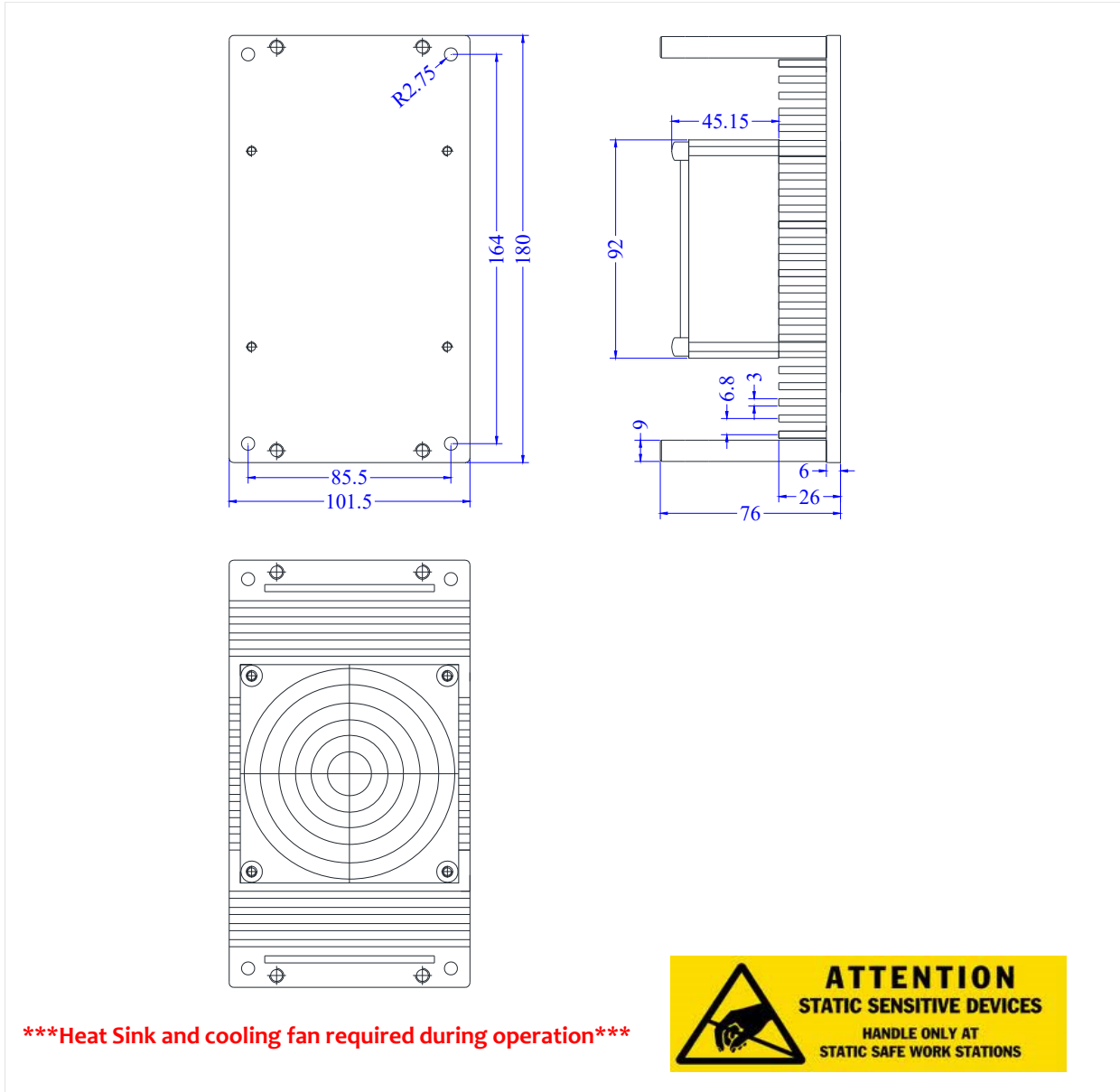

30W 2-6GHz Laser Sealed DB9 Port Controlled Wide Band PA

Important Notice

The information contained herein is believed to be reliable. RF-Lambda makes no warranties regarding the information contained herein. RF-Lambda assumes no responsibility or liability whatsoever for any of the information contained herein. RF-Lambda assumes no responsibility or liability whatsoever for the use of the information contained herein. The information contained herein is provided "AS IS, WHERE IS" and with all faults, and the entire risk associated with such information is entirely with the user. All information contained herein is subject to change without notice. Customers should obtain and verify the latest relevant information before placing orders for RF-Lambda products. The information contained herein or any use of such information does not grant, explicitly or implicitly, to any party any patent rights, licenses, or any other intellectual property rights, whether with regard to such information itself or anything described by such information.

RF-Lambda products are not warranted or authorized for use as critical components in medical, life-saving, or life sustaining applications, or other applications where a failure would reasonably be expected to cause severe personal injury or death.