

## Wide Band Solid State Power Amplifier 2GHz~20GHz



### Product Description

RFLUPA0220GA2 is a wideband power amplifier with a frequency range of 2 to 20GHz.

The power output of this amplifier is 42.5 dBm typical. The typical small signal gain is 50 dB with a flatness of  $\pm 3$ dB.

The power amplifier's input connector is SMA and output connector is SMA.

The operating temperature of this product is within -40 to +70°C.

### Features

- Wideband Solid State Power Amplifier
- Small Signal Gain 50dB Typical
- Output Saturation Power 42.5dBm Typical
- Supply Voltage +36VDC
- 50 Ohm Matched Input/Output

### Typical Applications

- Wireless Infrastructure
- Military and Aerospace Applications
- Test Instrumentation
- Radar Systems
- 5G Wireless Communications
- Microwave Radio Systems
- TR Modules
- Research and Development
- Cellular Base Stations

### Electrical Specifications (T<sub>A</sub>=+25°C)

Parameter	Min	Typ	Max	Min	Typ	Max	Units
Frequency Range		2 - 10		10 - 20			GHz
Small Signal Gain		50		47			dB
Gain Flatness		$\pm 3$		$\pm 3$			dB
Gain Variation Over Temperature (-40°C ~ +70°C)		$\pm 3$		$\pm 3$			dB
Input Return Loss		10		10			dB
*Saturated Output Power (Psat)		42.5		41.5			dBm
Isolation S12		55		57			dB
Supply Current (Vcc = +36VDC)		3200	5500	3200	5500		mA
Input Max Power (No damage)				Psat - Gain			dBm
Weight			2.83				lbs.
Impedance			50				Ohms
Input / Output Connectors				SMA -Female(Input)--SMA -Female(Output)			

\* P1dB, P3dB and Psat power test signal: 200 $\mu$ s pulse width with 10% duty cycle.

\* For average CW power testing or increased duty cycle, a 3dB back off from Psat is required.

**Absolute Maximum Ratings**

Parameter	Rating
Supply Voltage Range	+40VDC
*RF Input Power (RFIN)	Psat – Large Signal Gain

**Bias Up Procedure**

1. Connect ground
2. Connect input and output with 50 Ohm source/load.  
(In band VSWR < 1.9:1 or >10dB return loss.)
3. Connect positive supply and make sure power supply can handle max current.

**Bias Down Procedure**

1. Turn off power supply
2. Remove positive supply connection
3. Remove RF connection
4. Remove ground

**Environmental Specifications and Test Standards**

Parameter	Description
Operational Temperature	-40°C to +70°C (Case Temperature)
Storage Temperature	-55°C to +125°C
Thermal Shock	-40°C → +85°C (5 Cycles / 10 hours)
**Random Vibration	MIL-STD-202G Table 214-I, Test Condition Letter C 1.5 Hours Per Axis
High Temperature Burn In	Temperature +70°C for 72 Hours
Shock	1. Weight >20g, 50g half sine wave for 11ms, Speed variation 3.44m/s 2. Weight <=20g, 100g Half sine wave for 6ms, Speed variation 3.75m/s 3. Total 18 times (6 directions, 3 repetitions per direction).
Altitude	Standard: 30,000 Ft (Epoxy Sealed Controlled Environment) Optional: Hermetically Sealed (60,000 ft. 1.0 PSI min)
Hermetically Sealed (Optional)	MIL-STD-883 (For Hermetically Sealed Units)

\*Maximum RF input power is set to assure safety of amplifier. Input power may be increased at own risk to achieve full power of amplifier. Please reference gain and power curves.

\*\*For vibration testing details please see additional information section.

**Typical Performance Plots**

**Gain vs. Frequency**

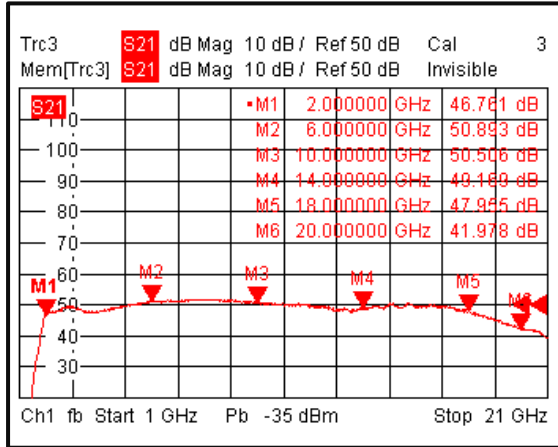

**Input Return Loss**

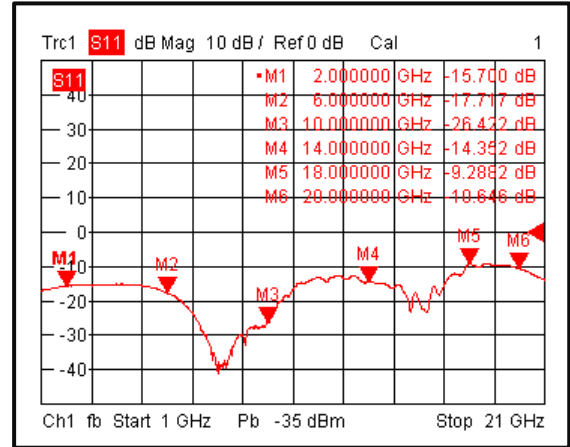

Typical Performance Plots

**Gain vs. Output Power**

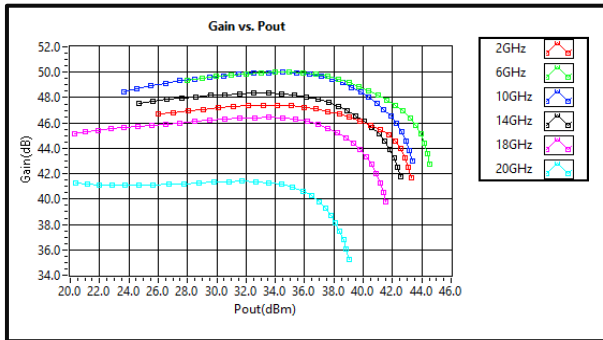

**PndB vs. Frequency**

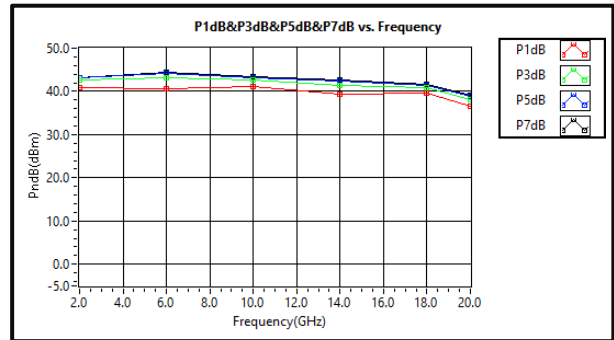

**Psat vs. Frequency**

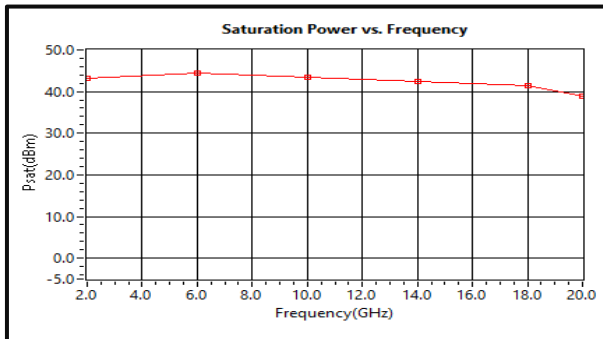

**Left IM3 vs. Output Power**

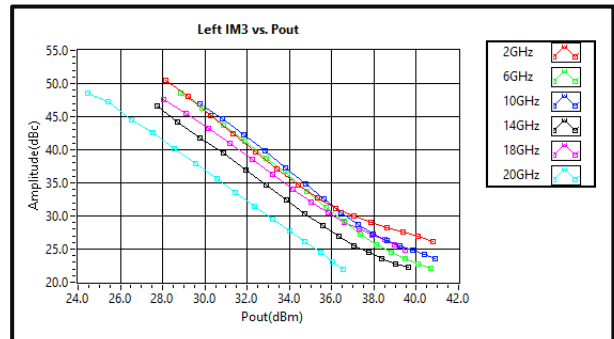

**Right IM3 vs. Output Power**

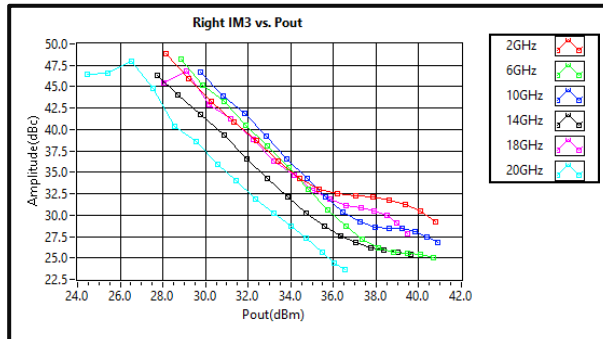

**Current vs. Output Power**

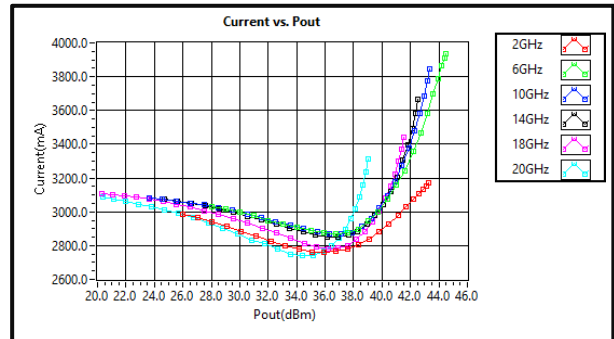

**Pout vs. Pin**

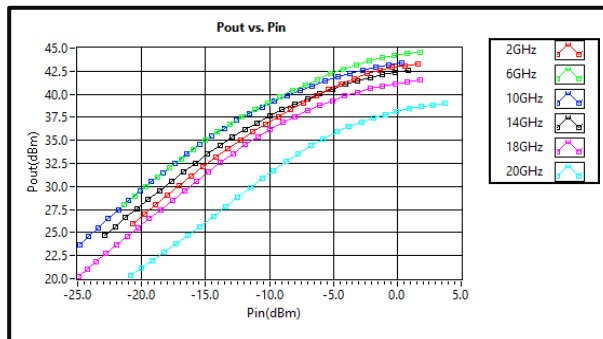

**Alarm Status Panel**

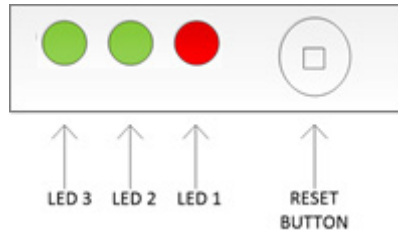

LED #	Name	Function	Initial State	Description	Applied
	Reset	Control		Manual reset button to reset PA	Yes
1	POWER	Indicator	RED Color	LED will light to RED color when supply power is applied	Yes
2	ID	Indicator	GREEN Color	PA will shut down and latch this LED to a RED color when an imbalance in the drain current of the combining branches occurs OR if a drain current limit is reached *	Yes
3	TEMP	Indicator	GREEN Color	PA will shut down and latch this LED to a RED color when driven over temperature *	Yes

\*LED needs to be manually reset to initial state by pressing RESET button

**Protection Connector Table**

Male D-Sub is on the housing

The female mating connector is provided within shipment. Part number: 172-E15-203R001

Pin #	Name	Function	Initial State	Description	Applied
1	Reset	Control		Resets PA when logic <u>LOW</u> is applied and released	Yes
2	Drain Disable	Control	LOW	Applying logic <u>HIGH</u> disables drains of amplifiers	Yes
3	Gate Disable	Control	LOW	Applying logic <u>HIGH</u> disables gates of amplifiers	Yes
4	RF IN Over	Indicator	LOW	Pin will be latched to logic <u>HIGH</u> when input signal is over limit	No
5	Temp Over	Indicator	LOW	Pin will be latched to logic <u>HIGH</u> when amplifier is driven over temperature	Yes
6	Current Over	Indicator	LOW	Pin will be latched to logic <u>HIGH</u> when drain current limit is reached	Yes
7	ID Imbalance	Indicator	LOW	Pin will be latched to logic <u>HIGH</u> when an imbalance in the drain current of the combining branches occurs	No
8	GND	Ground	GND	Ground	Yes
9	VDC	VDC	NA	VDC (must be able to support 5A) All VDC pins must be tied together	Yes
10	VDC	VDC	NA	VDC (must be able to support 5A) All VDC pins must be tied together	Yes
11	VDC	VDC	NA	VDC (must be able to support 5A) All VDC pins must be tied together	Yes
12	Temp Signal	Indicator	NA	PA carrier case temperature is represented by voltage	Yes
13	+5V	Power Supply	+5V	+5V DC is available for reference (400mA Current Ability)	Yes
14	GND	Ground	GND	Ground	Yes
15	GND	Ground	GND	Ground	Yes

Notes:

- HIGH/LOW voltages are standard TTL signals 0.0V-0.8V = LOW. 2V-5V = HIGH. Input current is 10uA.
- Matching connector and cable will be shipped with the product.
- Applied=Yes means the feature is included. Applied=No means the feature is not included with this model.
- 5V reference supply can source 700mA.
- Indicator output signals can source 24mA.

**Outline Drawing**

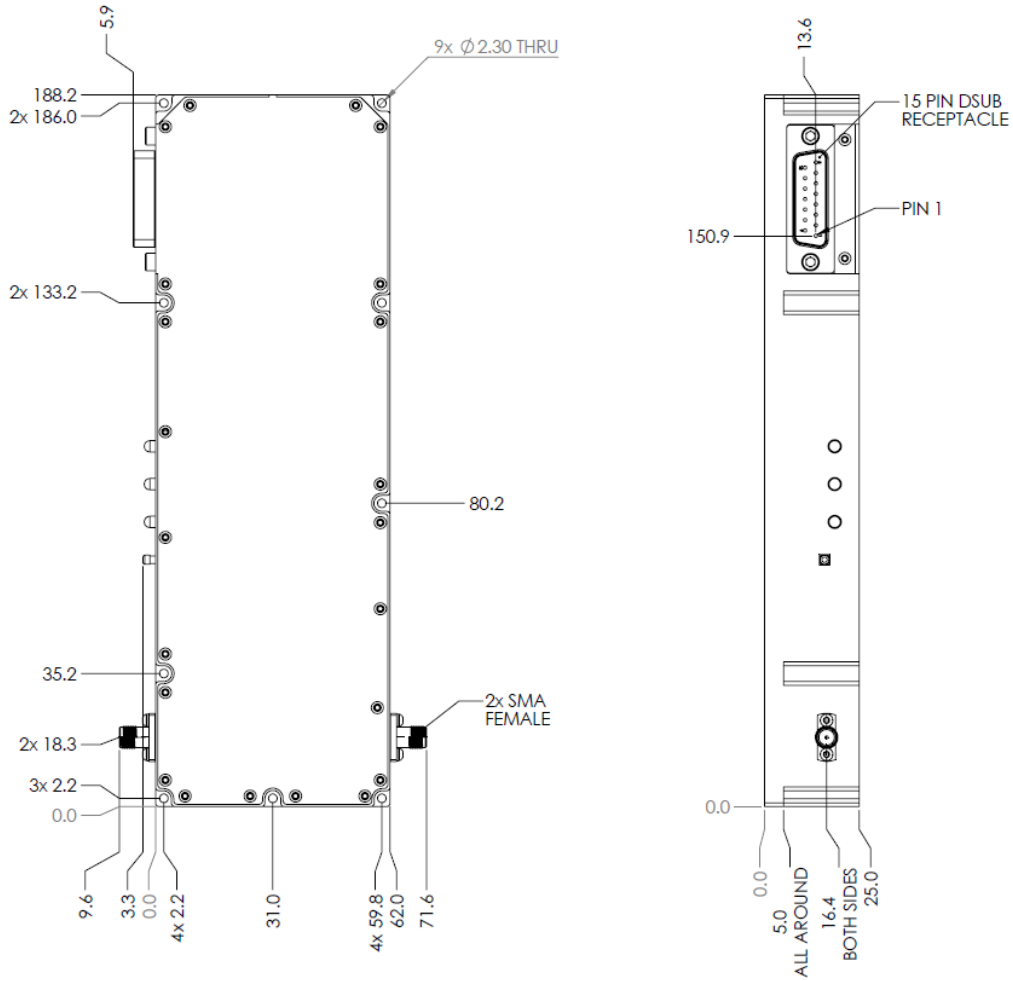

**Notes:**

1. Package Material: Aluminum and Copper
2. Plating: Nickel
3. All dimensions are in millimeters [inches].
4. Tolerances  $\pm 0.25$  [0.010] unless otherwise specified.
5. Heat sink required during operation (sold separately). Matching heatsink is listed on our website. If customer would like to use their own cooling method, please make sure the amplifier will operate under the specs that listed in page 2 of this datasheet.

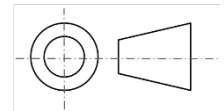

**Additional Information**

Documentation	Webpage
ESD Policy	<a href="https://rflambda.com/pdf/rflambda_esd_control.pdf">https://rflambda.com/pdf/rflambda_esd_control.pdf</a>
Heatsink Lookup Specifications	<a href="https://rflambda.com/search_heatsink.jsp">https://rflambda.com/search_heatsink.jsp</a>
Connector Torque Specifications	<a href="https://www.rflambda.com/pdf/Torque_Specifications.pdf">https://www.rflambda.com/pdf/Torque_Specifications.pdf</a>
Random Vibration Test Standard	<a href="https://www.rflambda.com/pdf/rflambda_random_vibration_MIL-STD-202G.pdf">https://www.rflambda.com/pdf/rflambda_random_vibration_MIL-STD-202G.pdf</a>

**Ordering Information**

Part Number	Modification	Description
RFLUPA0220GA2	Input connector SMA and Output connector SMA	2GHz-20GHz Power Amplifier

**Amplifier Use**

Ensure that the amplifier input and output ports are safely terminated into a proper 50 ohm load before turning on the power. Never operate the amplifier without a load. A proper 50 ohm load is defined as a load with impedance less than 1.9:1 or return loss larger than 10dB relative to 50 Ohm within the specified operating band width.

Power Supply Requirements

Power supply must be able to provide adequate current for the amplifier. Power supply should be able to provide 1.5 times the typical current or 1.2 times the maximum current (whichever is greater).

In most cases, RF - Lambda amplifiers will withstand severe mismatches without damage. However, operation with poor loads is discouraged. If prolonged operation with poor or unknown loads is expected, an external device such as an isolator or circulator should be used to protect the amplifier.

Ensure that the power is off when connecting or disconnecting the input or output of the amp.

Prevent overdriving the amplifier. Do not exceed the recommended input power level.

Adequate heat-sinking required for RF amplifier modules. Please inquire.

Amplifiers do not contain Thermal protection, Reverse DC polarity or Over voltage protection with the exception of a few models. Please inquire.

Proper electrostatic discharge (ESD) precautions are recommended to avoid performance degradation or loss of functionality.

What is not covered with warranty?

Each RF - Lambda amplifier will go through power and temperature stress testing. Since the die, ICs or MMICs are fragile, these are not covered by warranty. Any damage to these will NOT be free to repair.

**Important Notice**

The information contained herein is believed to be reliable. RF-Lambda makes no warranties regarding the information contained herein. RF-Lambda assumes no responsibility or liability whatsoever for any of the information contained herein. RF-Lambda assumes no responsibility or liability whatsoever for the use of the information contained herein. The information contained herein is provided "AS IS, WHERE IS" and with all faults, and the entire risk associated with such information is entirely with the user. All information contained herein is subject to change without notice. Customers should obtain and verify the latest relevant information before placing orders for RF-Lambda products. The information contained herein or any use of such information does not grant, explicitly or implicitly, to any party any patent rights, licenses, or any other intellectual property rights, whether with regard to such information itself or anything described by such information.

RF-Lambda products are not warranted or authorized for use as critical components in medical, life-saving, or life sustaining applications, or other applications where a failure would reasonably be expected to cause severe personal injury or death.