

Wide Band Solid State Power Amplifier 2GHz~22GHz



Features

- Solid State Power Amplifier
- Gain: 43dB Typical
- Output Power: +43dBm Typical

Typical Applications

- Wireless Infrastructure
- Test and Measurement
- Military and Aerospace

Electrical Specifications, $T_A = +25^\circ\text{C}$, $V_{dd} = +36\text{V}$

Parameter	Min	Typ	Max	Units
Frequency Range	2 - 22			GHz
Gain		43		dB
Gain Variation Over Temperature		5	8	dB
Input Return Loss		-15		dB
Output Return Loss		-13		dB
Saturated Power (Psat)		43		dBm
Supply Current (Vdd=+36V)		2.8	5	A
Power Supply	30	36	55	V
Isolation S12		-55		dB
Input Max	Psat – Gain			dBm
Weight	≈ 1000			g
Impedance	50			Ohms
Power Connector	D-Sub			
Input / Output Connectors	SMA-Female			
Finish	Nickel Plated			
Material	Aluminum / Copper			

* P1dB, P3dB and Psat power testing signal: 200μs pulse width with 10% duty cycle.

* For average CW power testing or increased duty cycle, a 5dB back off from Psat is required unless water/oil cooling system is applied.

Absolute Maximum Ratings	
Supply Voltage	+55 VDC
RF Input Power (RFIN) Pin_max = Psat - Gainsat	Psat - Gain

Note: Maximum RF input power is set to assure safety of amplifier. Input power may be increased at own risk to achieve full power of amplifier. Please reference gain and power curves.

Biasing Up Procedure	
Step 1	Connect Ground Pin
Step 2	Connect input and output with 50 Ohm source/load. (in band VSWR<1.9:1 or >10dB return loss)
Step 3	Connect +Vcc biasing
Power OFF Procedure	
Step 1	Turn off +Vcc biasing
Step 2	Remove RF connection
Step 3	Remove Ground.

Environmental Specifications and Test Standards

Parameter	Description
Operational Temperature	-45°C~+55°C (Case Temperature less than +85°C)
Storage Temperature	-50°C~+125°C
Thermal Shock	-45°C → +85°C (5 Cycles / 10 hours)
Random Vibration	MIL-STD-202G Table 214-I, Test Condition Letter C 1.5 Hours Per Axis
High Temperature Burn In	Temperature +85°C for 72 Hours
Shock	1. Weight >20g, 50g half sine wave for 11ms, Speed variation 3.44m/s 2. Weight <=20g, 100g Half sine wave for 6ms, Speed variation 3.75m/s 3. Total 18 times (6 directions, 3 repetitions per direction).
Altitude	Standard: 30,000 Ft (Epoxy Sealed Controlled Environment) Optional: Hermetically Sealed (60,000 ft. 1.0 PSI min)
Hermetically Sealed (Optional)	MIL-STD-883 (For Hermetically Sealed Units)

Note: The operating temperature for the unit is specified at the package base. It is the user's responsibility to ensure the part is in an environment capable of maintaining the temperature within the specified limits

Ordering Information	
Part No.	Description
RFLUPA01G22GA2	2GHz~22GHz Power Amplifier

Amplifier Use

Ensure that the amplifier input and output ports are safely terminated into a proper 50 ohm load before turning on the power. Never operate the amplifier without a load. A proper 50 ohm load is defined as a load with impedance less than 1.9:1 or return loss larger than 10dB relative to 50 Ohm within the specified operating band width.

Power Supply Requirements

Power supply must be able to provide adequate current for the amplifier. Power supply should be able to provide 1.5 times the typical current or 1.2 times the maximum current (whichever is greater).

In most cases, RF - Lambda amplifiers will withstand severe mismatches without damage. However, operation with poor loads is discouraged. If prolonged operation with poor or unknown loads is expected, an external device such as an isolator or circulator should be used to protect the amplifier.

Ensure that the power is off when connecting or disconnecting the input or output of the amp.

Prevent overdriving the amplifier. Do not exceed the recommended input power level.

Adequate heat-sinking required for RF amplifier modules. Please inquire.

Amplifiers do not contain Thermal protection, Reverse DC polarity or Over voltage protection with the exception of a few models. Please inquire.

Proper electrostatic discharge (ESD) precautions are recommended to avoid performance degradation or loss of functionality.

What is not covered with warranty?

Each RF - Lambda amplifier will go through power and temperature stress testing. Since the die, ICs or MMICs are fragile, these are not covered by warranty. Any damage to these will NOT be free to repair.

Wide Band Solid State Power Amplifier 2-22GHz

Typical Performance Plots

Gain vs. Frequency

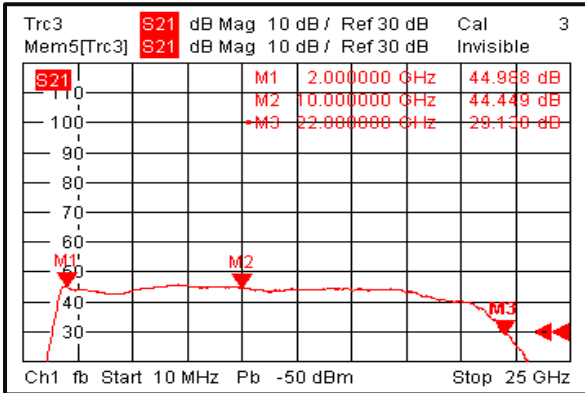

Input Return Loss

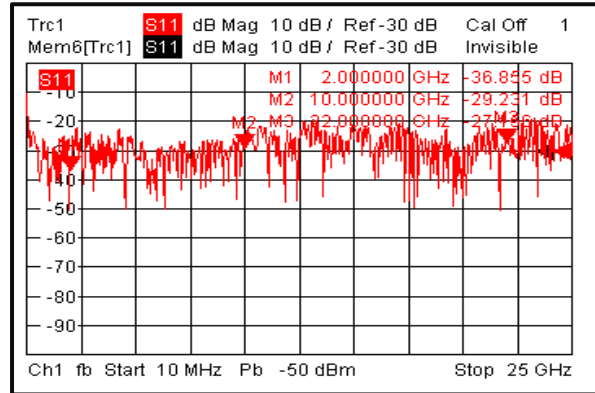

Output Return Loss

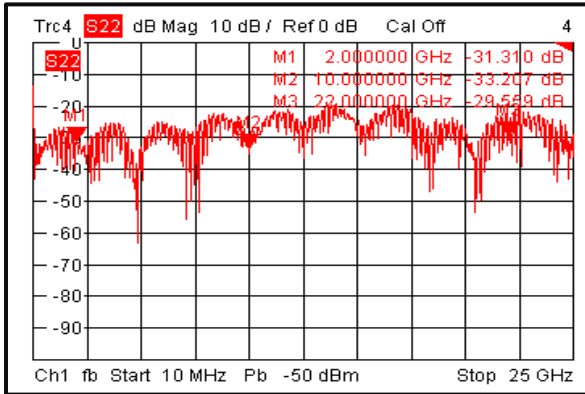

Isolation

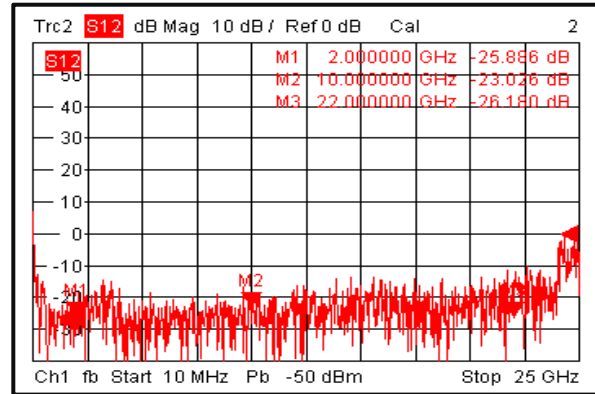

Note: Input/output return loss measurements include attenuators to protect equipment

Wide Band Solid State Power Amplifier 2-22GHz

Gain vs. Output Power

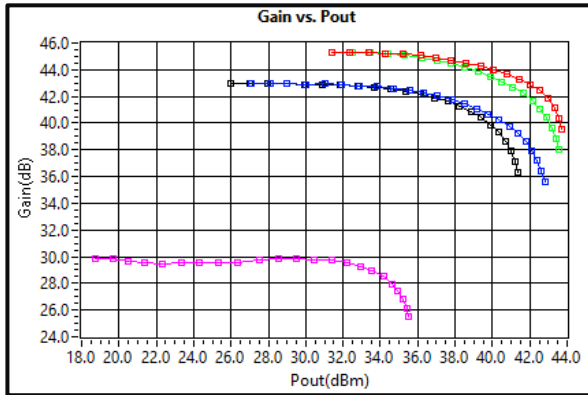

PSat vs. Frequency

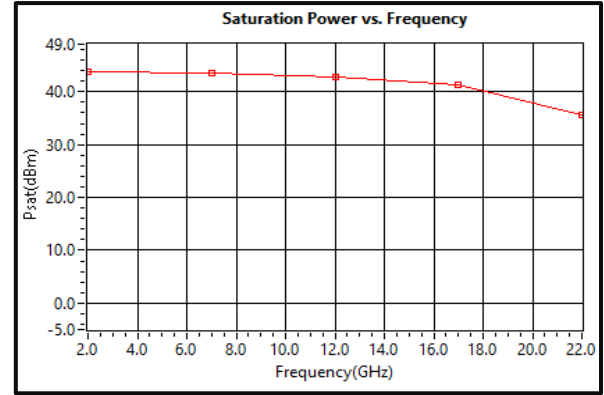

Current vs. Output Power

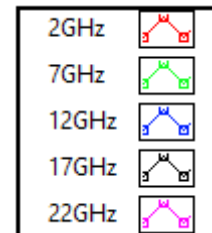
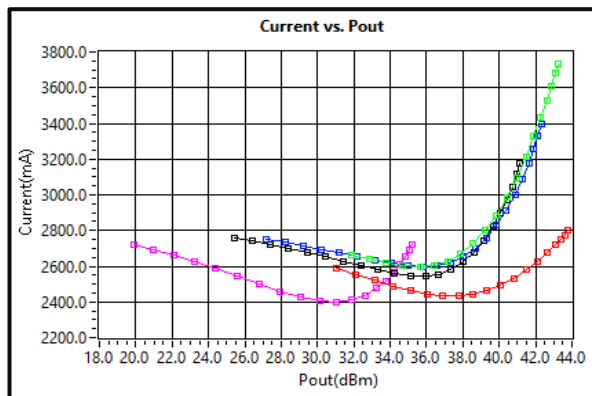

Wide Band Solid State Power Amplifier 2-22GHz

10% Duty Cycle 200us Pulse Width

User Interface Table:
(Male d-sub connector on the housing)



Pin #	Name	Function	Initial State	Description	Applied
1	Reset	Control		Resets PA when logic <u>LOW</u> is applied and released	Yes
2	Drain Disable	Control	LOW	Applying logic <u>HIGH</u> disables drains of amplifiers	Yes
3	Gate Disable	Control	LOW	Applying logic <u>HIGH</u> disables gates of amplifiers	Yes
4	RF IN Over	Indicator	LOW	Pin will be latched to logic <u>HIGH</u> when input signal is over limit	No
5	Temp Over	Indicator	LOW	Pin will be latched to logic <u>HIGH</u> when amplifier is driven over temperature	Yes
6	Current Over	Indicator	LOW	Pin will be latched to logic <u>HIGH</u> when drain current limit is reached	Yes
7	ID Imbalance	Indicator	LOW	Pin will be latched to logic <u>HIGH</u> when an imbalance in the drain current of the combining branches occurs	No
8	GND	Ground	GND	Ground	Yes
9	VDC	Power Supply	VDC	VDC (must be able to support 5A) All VDC pins must be tied together	Yes
10	VDC	Power Supply	VDC	VDC (must be able to support 5A) All VDC pins must be tied together	Yes
11	VDC	Power Supply	VDC	VDC (must be able to support 5A) All VDC pins must be tied together	Yes
12	Temp Signal	Indicator		PA carrier case temperature is represented by voltage	Yes
13	+5V	Reference	+5V	+5V DC is available for reference (400mA Current Ability)	Yes
14	GND	Ground	GND	Ground	Yes
15	GND	Ground	GND	Ground	Yes

HIGH/LOW voltages are standard TTL signals:
0.0V-0.8V = LOW
2V-5V = HIGH

Wide Band Solid State Power Amplifier 2-22GHz

Alarm Status Panel:

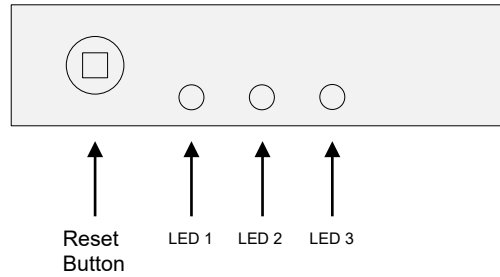

	Name	Function	Initial State	Description	Applied
	RESET	Control		Manual reset button to reset PA	Yes
LED 1	POWER	Indicator	RED Color	LED will light to RED color when supply power is applied	Yes
LED 2	ID	Indicator	GREEN Color	PA will shut down and latch this LED to a RED color when an imbalance in the drain current of the combining branches occurs or if a drain current limit is reached *	Yes
LED 3	TEMP	Indicator	GREEN Color	PA will shut down and latch this LED to a RED color when driven over temperature *	Yes

*LED needs to be manually reset to initial state by pressing RESET button

Outline Drawing:

All Dimensions in mm

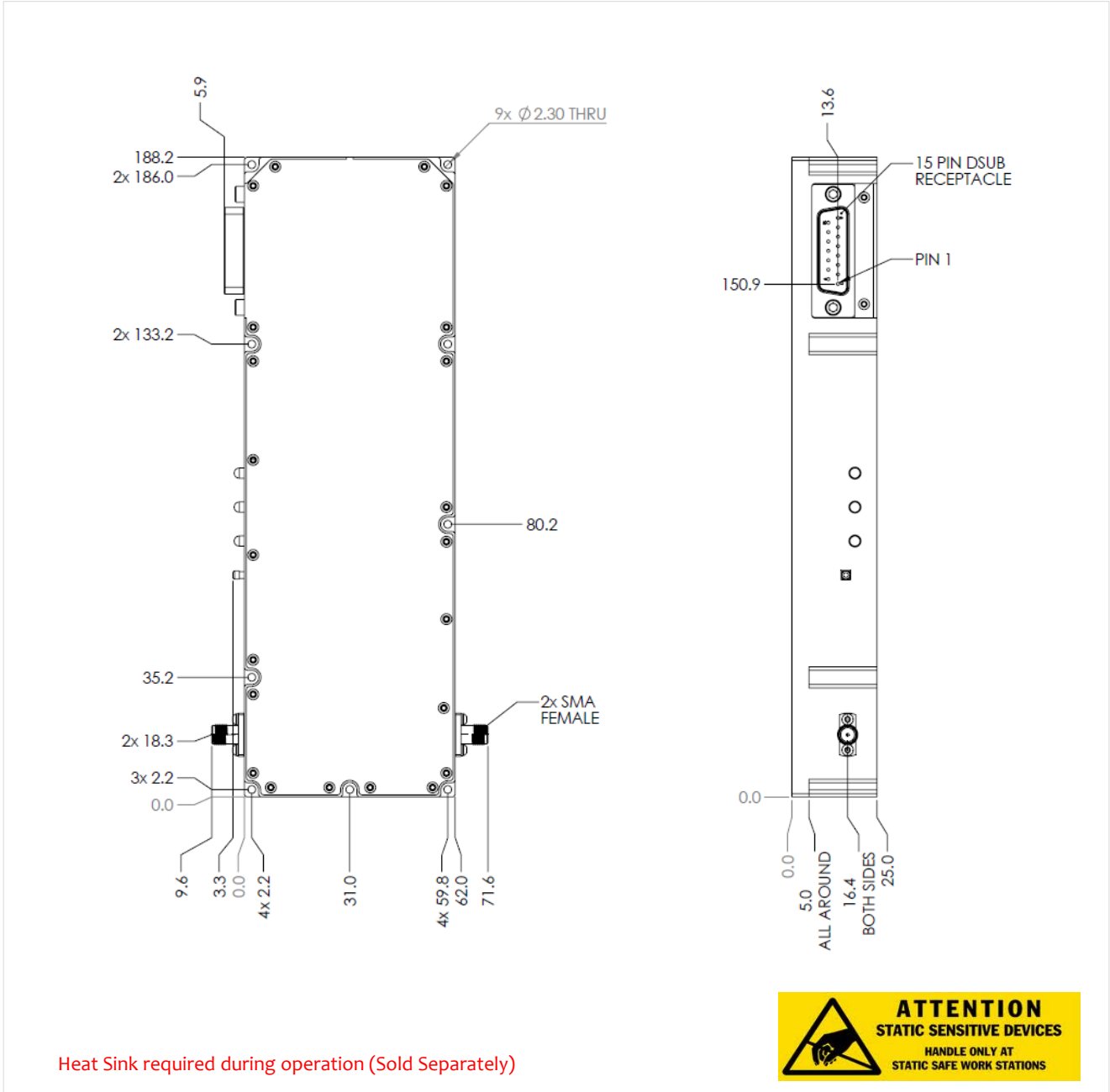

Wide Band Solid State Power Amplifier 2-22GHz

Important Notice

The information contained herein is believed to be reliable. RF-Lambda makes no warranties regarding the information contained herein. RF-Lambda assumes no responsibility or liability whatsoever for any of the information contained herein. RF-Lambda assumes no responsibility or liability whatsoever for the use of the information contained herein. The information contained herein is provided "AS IS, WHERE IS" and with all faults, and the entire risk associated with such information is entirely with the user. All information contained herein is subject to change without notice. Customers should obtain and verify the latest relevant information before placing orders for RF-Lambda products. The information contained herein or any use of such information does not grant, explicitly or implicitly, to any party any patent rights, licenses, or any other intellectual property rights, whether with regard to such information itself or anything described by such information. RF-Lambda products are not warranted or authorized for use as critical components in medical, life-saving, or life sustaining applications, or other applications where a failure would reasonably be expected to cause severe personal injury or death.