

## Ultra Wide Band Mixer (Bi-Directional) 14GHz - 36GHz



### Features

- Ultra Wide Band Mixer
- High Dynamic Range

### Product Description

RMX14G36GA is an ultra wideband mixer with a frequency range of 14 to 36GHz.

The LO power of the mixer is 15dBm. The conversion loss is 10dB.

The operating temperature of this product is -40 to +85°C.

### Typical Applications

- Wireless Infrastructure
- Military and Aerospace Applications
- Test Instrumentation
- Radar Systems
- 5G Wireless Communications
- Microwave Radio Systems
- TR Modules
- Research and Development
- Cellular Base Stations

### Electrical Specifications (T<sub>A</sub>=+25°C)

Parameter	Min	Typ	Max	Units
RF Input Frequency	14		36	GHz
LO Input Frequency	20		50	GHz
IF Output Frequency	DC		24	GHz
LO Power		15		dBm
Conversion Loss		10	17	dB
Input 1dB Compression (P1dB)		0		dBm
Input Third Order Intercept (IIP3)		23		dBm
Isolation		45		dB
Weight		0.03 Max.		lbs.
RF& IF / LO Connectors	2.92mm-Female / 2.4mm-Female			
Frequency Relationship	RF=IF+LO			
Package	Epoxy Sealed (Standard)			
	Hermetically Sealed (Optional)			

**Absolute Maximum Ratings**

Parameter		Rating
RF Input Power	RF	+17dBm
	IF	+17dBm
	LO	+17dBm

**Environmental Specifications and Test Standards**

Parameter	Description
Operational Temperature	-40°C to +85°C (Case Temperature)
Storage Temperature	-50°C to +105°C
Thermal Shock	-40°C → +85°C (5 Cycles / 10 hours)
**Random Vibration	MIL-STD-202G Table 214-I, Test Condition Letter C 1.5 Hours Per Axis
High Temperature Burn In	Temperature +85°C for 72 Hours
Shock	1. Weight >20g, 50g half sine wave for 11ms, Speed variation 3.44m/s 2. Weight <=20g, 100g Half sine wave for 6ms, Speed variation 3.75m/s 3. Total 18 times (6 directions, 3 repetitions per direction).
Altitude	Standard: 30,000 Ft (Epoxy Sealed Controlled Environment) Optional: Hermetically Sealed (60,000 ft. 1.0 PSI min)
Hermetically Sealed (Optional)	MIL-STD-883 (For Hermetically Sealed Units)

Typical Performance Plots

**Conversion Loss**

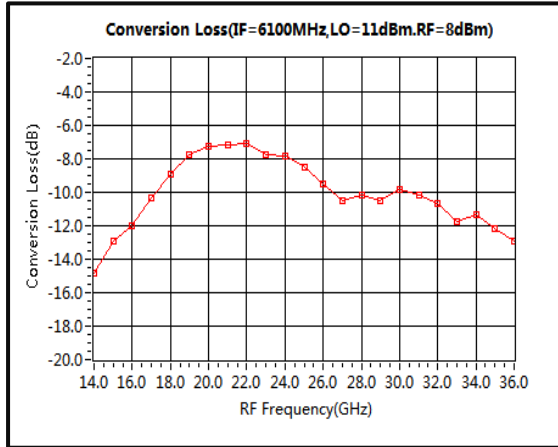

**Conversion Loss vs. LO Power**

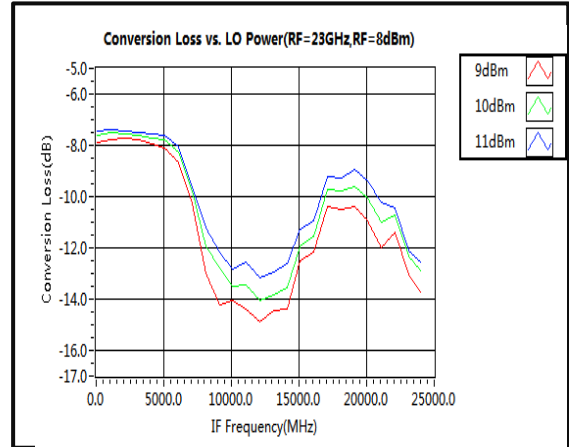

**IF Level vs. RF Level (IF=LO-RF)**

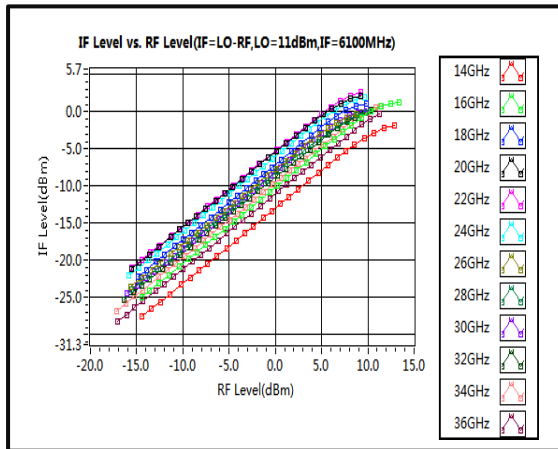

**IF Level vs. RF Level (IF=RF-LO)**

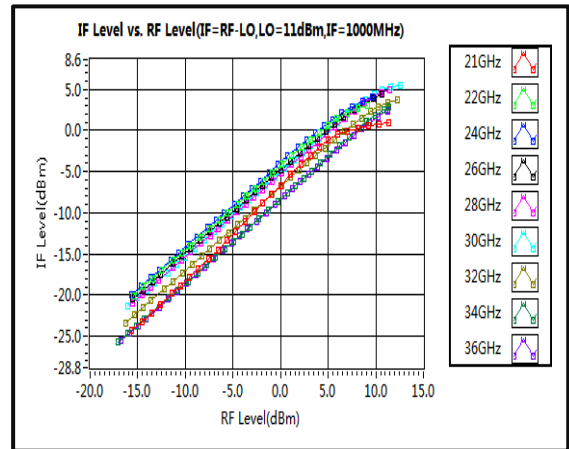

**RF P1dB (IF=LO-RF)**

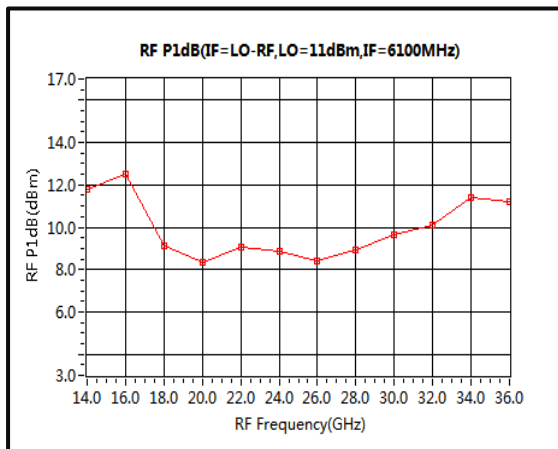

**RF P1dB (IF=RF-LO)**

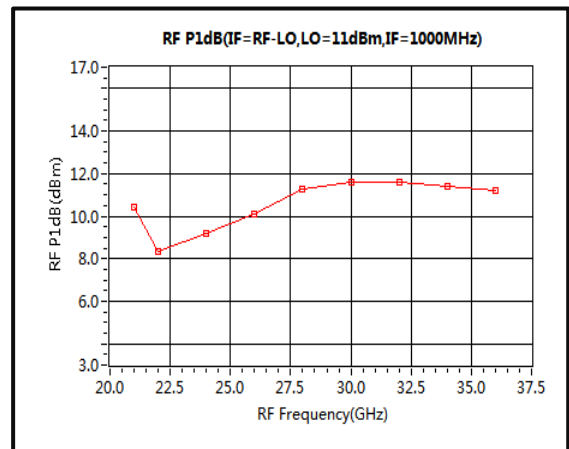

Typical Performance Plots

**RF-IF Isolation**

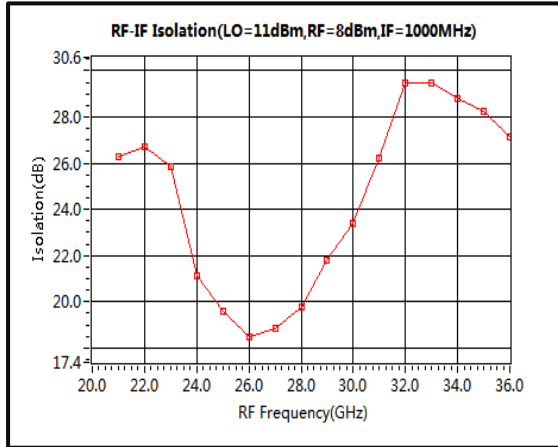

**LO-IF Isolation**

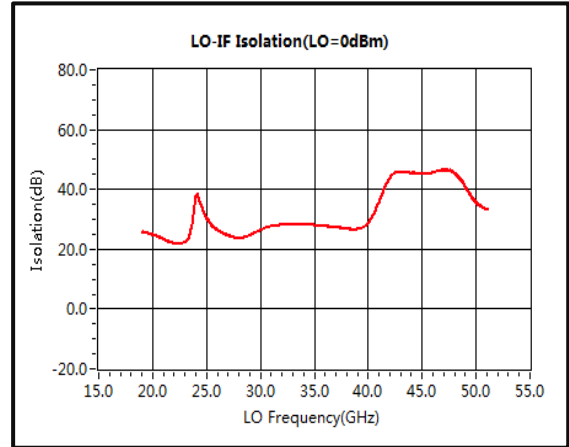

**LO-RF Isolation**

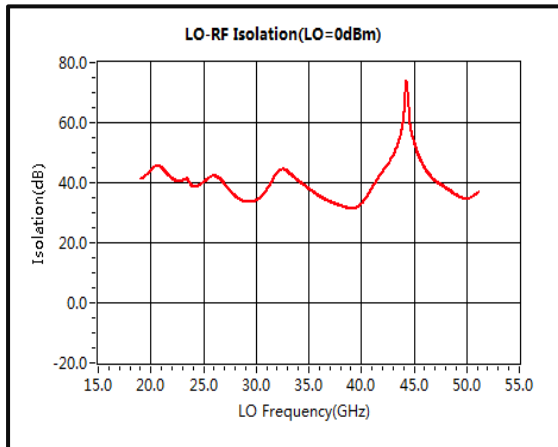

**RF IIP3**

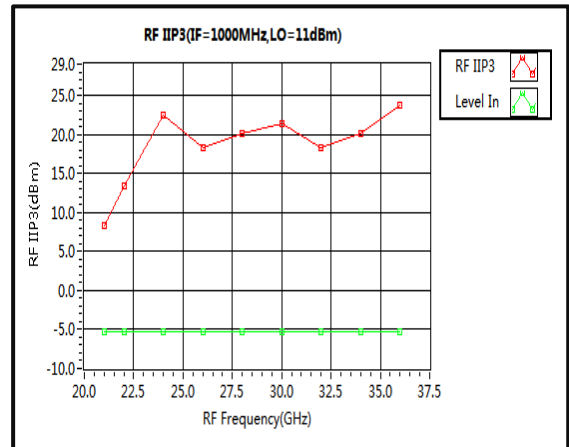

**Outline Drawing**

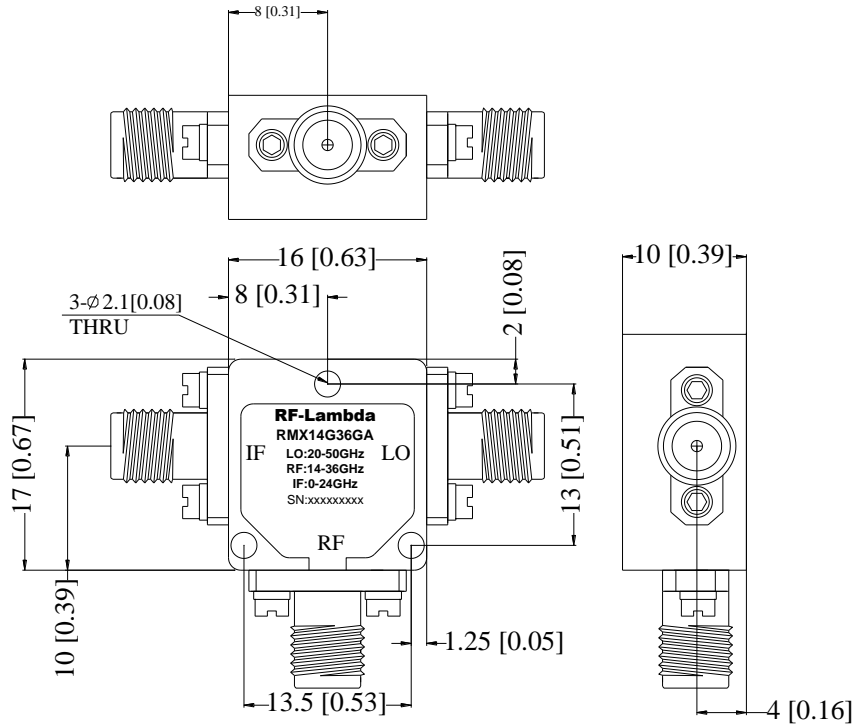

Notes:

1. Package Material: Aluminum
2. Finish: Gold Plated
3. All dimensions are in millimeters [inches].
4. Housing Tolerances  $\pm 0.1$  [0.004] unless otherwise specified.
5. Standard torque wrench must be used to secure RF connectors.

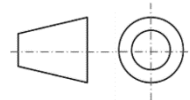

Additional Information

Documentation	Webpage
ESD Policy	<a href="https://rflambda.com/pdf/rflambda_esd_control.pdf">https://rflambda.com/pdf/rflambda_esd_control.pdf</a>
Connector Torque Specifications	<a href="https://www.rflambda.com/pdf/Torque_Specifications.pdf">https://www.rflambda.com/pdf/Torque_Specifications.pdf</a>
Random Vibration Test Standard	<a href="https://www.rflambda.com/pdf/rflambda_random_vibration_MIL-STD-202G.pdf">https://www.rflambda.com/pdf/rflambda_random_vibration_MIL-STD-202G.pdf</a>

**Ordering Information**

Part Number	Modification	Description
RMX14G36GA	Connectors 2.92mm-Female / 2.4mm-Female	14GHz-36GHz Ultra Wide Band Mixer (Bi-Directional)

**Important Notice**

The information contained herein is believed to be reliable. RF-Lambda makes no warranties regarding the information contained herein. RF-Lambda assumes no responsibility or liability whatsoever for any of the information contained herein. RF-Lambda assumes no responsibility or liability whatsoever for the use of the information contained herein. The information contained herein is provided "AS IS, WHERE IS" and with all faults, and the entire risk associated with such information is entirely with the user. All information contained herein is subject to change without notice. Customers should obtain and verify the latest relevant information before placing orders for RF-Lambda products. The information contained herein or any use of such information does not grant, explicitly or implicitly, to any party any patent rights, licenses, or any other intellectual property rights, whether with regard to such information itself or anything described by such information.

RF-Lambda products are not warranted or authorized for use as critical components in medical, life-saving, or life sustaining applications, or other applications where a failure would reasonably be expected to cause severe personal injury or death.