

Hermetically Sealed Coaxial 30W 0° 4-Way Power Divider 6GHz-18GHz



Product Description

RFLT4W6G18G-H is 4-way hermetically sealed power divider with a frequency range of 6 to 18GHz.

The forward power handling of this power divider is 30W. The insertion loss is 0.9dB with a typical isolation of 20dB.

The working temperature of this product is between - 40°C and + 85°C.

Features

- High power handling up to 30W
- Wide band operation
- High isolation within operational band
- Low Insertion Loss

Typical Applications

- Wireless Infrastructure
- Military and Aerospace Applications
- Test Instrumentation
- Radar Systems
- 5G Wireless Communications
- Microwave Radio Systems
- TR Modules
- Research and Development
- Cellular Base Stations

Electrical Specifications, TA = +25°C

Parameter		Min	Typ	Max	Min	Typ	Max	Units
Frequency Range		6		12	12		18	GHz
Nominal Splitter Loss			6			6		dB
Insertion Loss			0.8	1.0		1.0	1.2	dB
Isolation		18	20		18	19		dB
Input VSWR			1.5	1.6		1.5	1.6	: 1
Output VSWR			1.4	1.5		1.4	1.5	: 1
Amplitude Imbalance			±0.2	±0.3		±0.2	±0.3	dB
Phase Imbalance			±4	±5		±5	±6	deg
Power Rating	Forward Power			30				W
	Reverse Power			1				W
	Peak Power			300 (10% Duty Cycle, 1 us Pulse Width)				W
Weight				0.17 Max.				lbs
Impedance				50				Ω
Input / Output Connectors		SMA-Female(Input) – SMA-Female(Output)						
Package		Hermetically Sealed (Laser Welded)						

Environmental Specifications and Test Standards

Parameter	Description
Operational Temperature	-40°C to +85°C (Case Temperature)
Storage Temperature	-50°C to +105°C
Thermal Shock	-40°C → +85°C (5 Cycles / 10 hours)
**Random Vibration	MIL-STD-202G Table 214-I, Test Condition Letter C 1.5 Hours Per Axis
Shock	1. Weight >20g, 50g half sine wave for 11ms, Speed variation 3.44m/s 2. Weight <=20g, 100g Half sine wave for 6ms, Speed variation 3.75m/s 3. Total 18 times (6 directions, 3 repetitions per direction).
Altitude	Standard: 30,000 Ft (Epoxy Sealed Controlled Environment) Optional: Hermetically Sealed (60,000 ft. 1.0 PSI min)
Hermetically Sealed (Optional)	MIL-STD-883 (For Hermetically Sealed Units)

*For vibration testing details please see additional information section.

Typical Performance Plots

Loss & Amplitude Imbalance

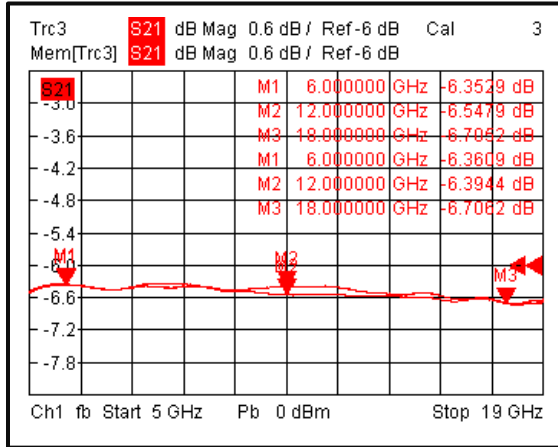

Input VSWR

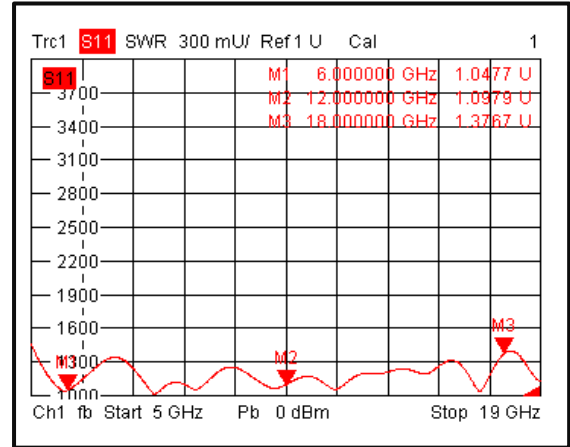

Output VSWR

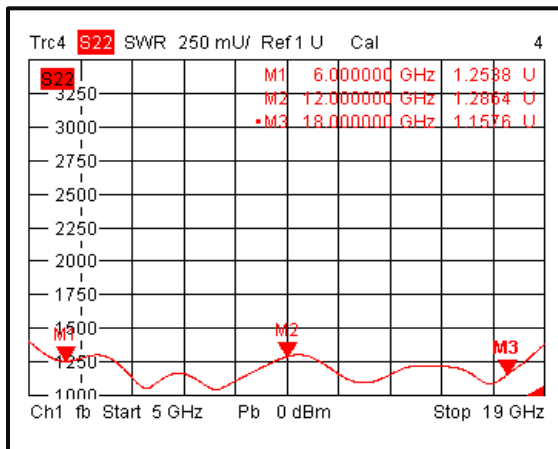

Isolation

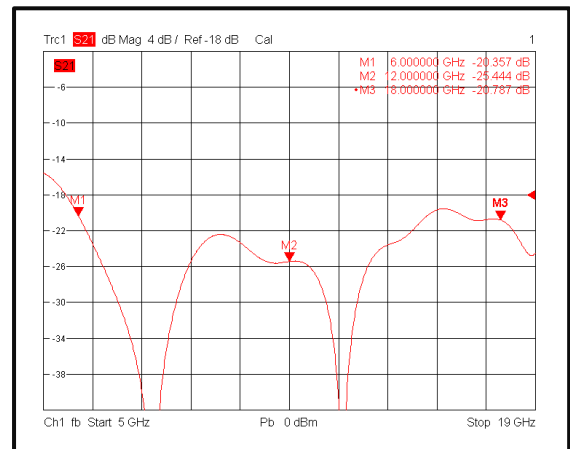

Phase Imbalance

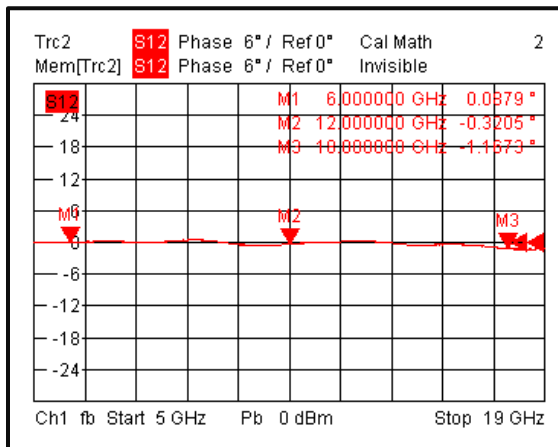

Outline Drawing

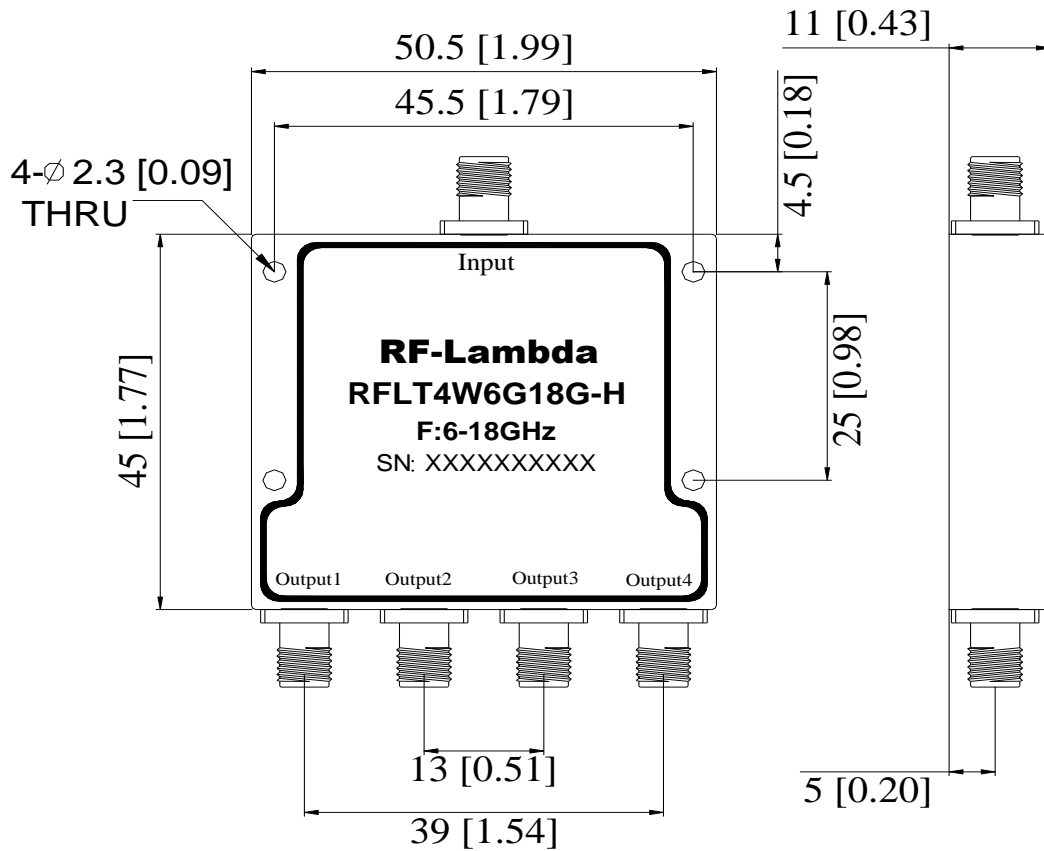

Notes:

1. Package Material: Aluminum
2. Finish: Blue Paint
3. All dimensions are in millimeters [inches].
4. Outline Tolerances ± 0.5 [0.02], Mounting Hole Tolerances ± 0.2 [0.008] unless otherwise specified.
5. Standard torque wrench must be used to secure RF connectors.

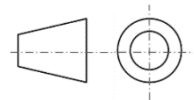

Additional Information

Documentation	Webpage
---------------	---------

Connector Torque Specifications

https://www.rflambda.com/pdf/Torque_Specifications.pdf

Random Vibration Test Standard

https://www.rflambda.com/pdf/rflambda_random_vibration_MIL-STD-202G.pdf

Ordering Information

Part Number	Modification	Description
RFLT4W6G18G-H	Connectors SMA-Female	6-18GHz Hermetically Sealed 4-Way Power Divider
RFLT4W6G18G	Standard	6-18GHz 4-Way Power Divider
RFLT4W6G18GN	Connectors N-Female	6-18GHz 4-Way Power Divider

Important Notice

The information contained herein is believed to be reliable. RF-Lambda makes no warranties regarding the information contained herein. RF-Lambda assumes no responsibility or liability whatsoever for any of the information contained herein. RF-Lambda assumes no responsibility or liability whatsoever for the use of the information contained herein. The information contained herein is provided "AS IS, WHERE IS" and with all faults, and the entire risk associated with such information is entirely with the user. All information contained herein is subject to change without notice. Customers should obtain and verify the latest relevant information before placing orders for RF-Lambda products. The information contained herein or any use of such information does not grant, explicitly or implicitly, to any party any patent rights, licenses, or any other intellectual property rights, whether with regard to such information itself or anything described by such information.

RF-Lambda products are not warranted or authorized for use as critical components in medical, life-saving, or life sustaining applications, or other applications where a failure would reasonably be expected to cause severe personal injury or death.