

Wide Band Drop-in Isolator 8.5GHz-10.5GHz



Product Description

RFLI504G08G10 is a wide band drop-in isolator with a frequency range of 8.5 to 10.5GHz.

The isolator has a typical isolation of 21dB. The maximum insertion loss is 0.3dB. The isolator has good isolation performance.

Features

- High power handling up to 10W
- Wide band operation
- High isolation within operational band
- Low Insertion Loss
- Stable performance over temperature
- High peak to average handling capability
- All specifications can be modified upon request

Typical Applications

- Wireless Infrastructure
- Military and Aerospace Applications
- Test Instrumentation
- Radar Systems
- 5G Wireless Communications
- Microwave Radio Systems
- TR Modules
- Research and Development
- Cellular Base Stations

Electrical Specifications (T_A=+25°C)

Parameter	Min.	Typ.	Max.	Units
Frequency Range		8.5-10.5		GHz
Insertion Loss		0.28	0.3	dB
Isolation	20	21		dB
VSWR		1.25	1.3	:1
Forward Power			10	W
Reverse Power			1	W
Phase		±15		deg
Rejection		>13		GHz
Rotation			Clockwise	
Input / Output Connectors			Drop-in	
Weight		0.012 Max.		lbs
Impedance		50		Ω

Environmental Specifications and Test Standards

Parameter	Description
Operational Temperature	-20°C to +70°C (Case Temperature)
Storage Temperature	-40°C to +85°C
Thermal Shock	-20°C → +70°C (5 Cycles / 10 hours)
**Random Vibration	MIL-STD-202G Table 214-I, Test Condition Letter C 1.5 Hours Per Axis
Shock	1. Weight >20g, 50g half sine wave for 11ms, Speed variation 3.44m/s 2. Weight <=20g, 100g Half sine wave for 6ms, Speed variation 3.75m/s 3. Total 18 times (6 directions, 3 repetitions per direction).
Altitude	Standard: 30,000 Ft (Epoxy Sealed Controlled Environment) Optional: Hermetically Sealed (60,000 ft. 1.0 PSI min)
Hermetically Sealed (Optional)	MIL-STD-883 (For Hermetically Sealed Units)

**For vibration testing details please see additional information section.

Typical Performance Plots

Insertion Loss

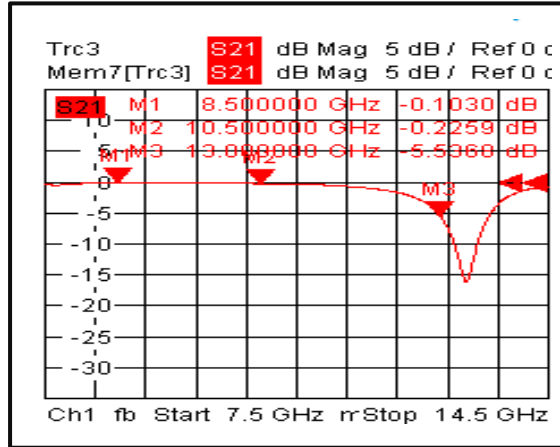

Isolation

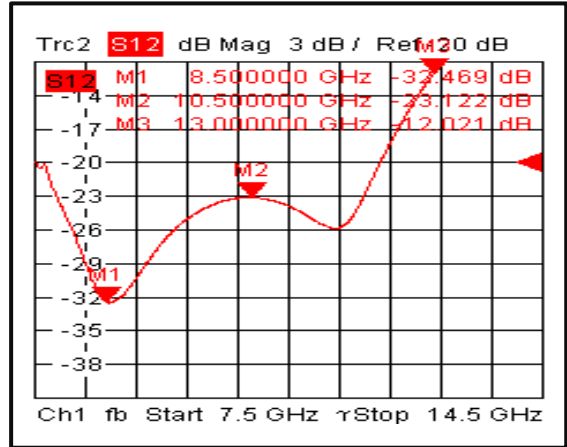

VSWR 1

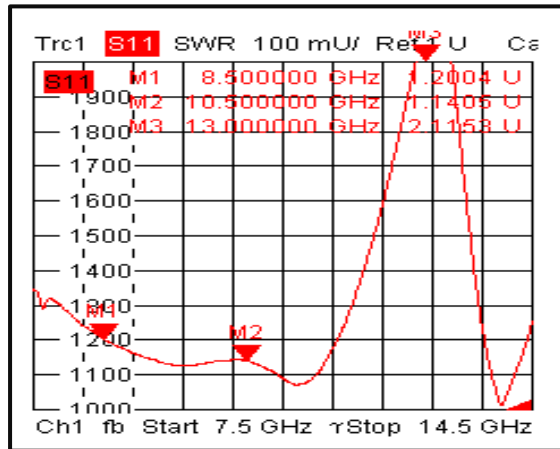

VSWR2

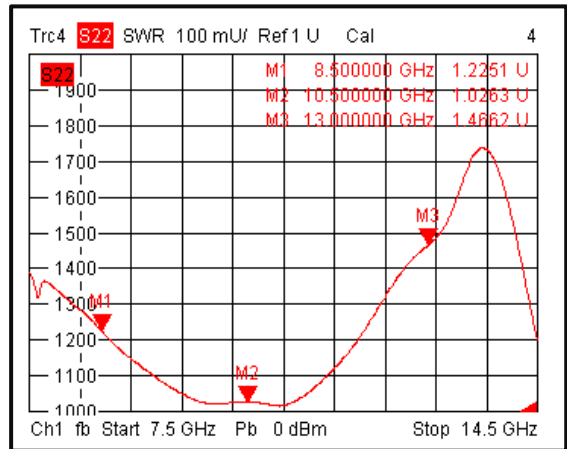

Phase

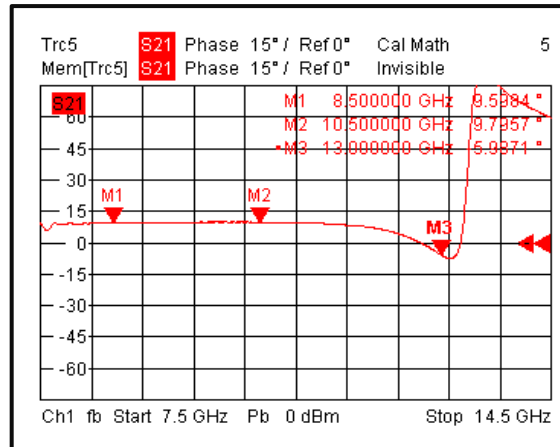

Outline Drawing

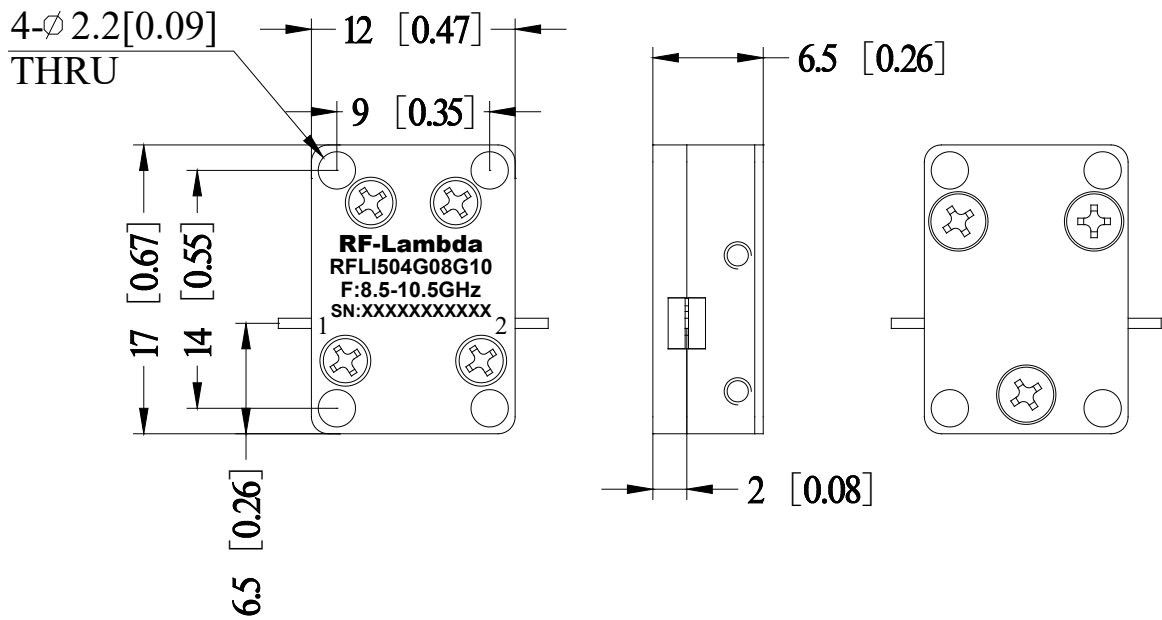

Notes:

1. Package Material: Aluminum alloy
2. Finish : Nickel Plated
3. All dimensions are in millimeters [inches]
4. Outline Tolerances ± 0.5 [0.02], Mounting Hole Tolerances ± 0.2 [0.008] unless otherwise specified.

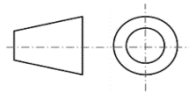

Additional Information

Documentation	Webpage
Connector Torque Specifications	https://www.rflambda.com/pdf/Torque_Specifications.pdf
Random Vibration Test Standard	https://www.rflambda.com/pdf/rflambda_random_vibration_MIL-STD-202G.pdf

Ordering Information

Part Number	Modification	Description
RFLI504G08G10	Connectors Drop-in	8.5-10.5GHz Drop-in Isolator

Important Notice

The information contained herein is believed to be reliable. RF-Lambda makes no warranties regarding the information contained herein. RF-Lambda assumes no responsibility or liability whatsoever for any of the information contained herein. RF-Lambda assumes no responsibility or liability whatsoever for the use of the information contained herein. The information contained herein is provided "AS IS, WHERE IS" and with all faults, and the entire risk associated with such information is entirely with the user. All information contained herein is subject to change without notice. Customers should obtain and verify the latest relevant information before placing orders for RF-Lambda products. The information contained herein or any use of such information does not grant, explicitly or implicitly, to any party any patent rights, licenses, or any other intellectual property rights, whether with regard to such information itself or anything described by such information.

RF-Lambda products are not warranted or authorized for use as critical components in medical, life-saving, or life sustaining applications, or other applications where a failure would reasonably be expected to cause severe personal injury or death.