

Suspended Substrate Stripline Low Pass Filter DC-14GHz

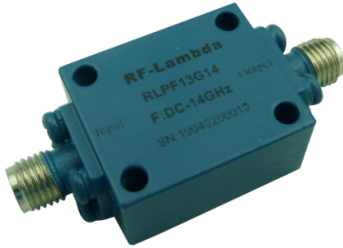

Product Description

RLPF13G14 is suspended substrate stripline low pass filter with a frequency range of DC to 14GHz.

The peak power of this low pass filter is 100W. The insertion loss is 0.8dB with a typical rejection of 60dB.

The working temperature of this product is between - 55°C and + 85°C.

Features

- Suspended Substrate Strip-line Filter
- Flat frequency response
- Low insertion loss

Typical Applications

- Wireless Infrastructure
- Military and Aerospace Applications
- Test Instrumentation
- Radar Systems
- 5G Wireless Communications
- Microwave Radio Systems
- TR Modules
- Research and Development
- Cellular Base Stations

Electrical Specifications, TA = +25°C

Parameter	Min	Typ	Max	Units
Frequency Range	DC		14	GHz
Insertion Loss		0.8	1.0	dB
Pass Band Ripple		0.6	0.8	dB
VSWR		1.4	1.6	: 1
Rejection	@16.2-20GHz	50	60	dB
Power Rating	Average		15	W
	Peak (10% Duty Cycle, 1 us Pulse Width)		100	W
Weight		0.05 Max.		lbs
Impedance		50		Ω
Input / Output Connectors	SMA-Female(Input) – SMA-Female(Output)			
Package	Epoxy Sealed (Standard)			
	Hermetically Sealed (Optional)			

Environmental Specifications and Test Standards

Parameter	Description
Operational Temperature	-55°C to +85°C (Case Temperature)
Storage Temperature	-55°C to +125°C
Thermal Shock	-55°C → +85°C (5 Cycles / 10 hours)
*Random Vibration	MIL-STD-202G Table 214-I, Test Condition Letter C 1.5 Hours Per Axis
Shock	1. Weight >20g, 50g half sine wave for 11ms, Speed variation 3.44m/s 2. Weight <=20g, 100g Half sine wave for 6ms, Speed variation 3.75m/s 3. Total 18 times (6 directions, 3 repetitions per direction).
Altitude	Standard: 30,000 Ft (Epoxy Sealed Controlled Environment) Optional: Hermetically Sealed (60,000 ft. 1.0 PSI min)
Hermetically Sealed (Optional)	MIL-STD-883 (For Hermetically Sealed Units)

*For vibration testing details please see additional information section.

Typical Performance Plots

Insertion Loss

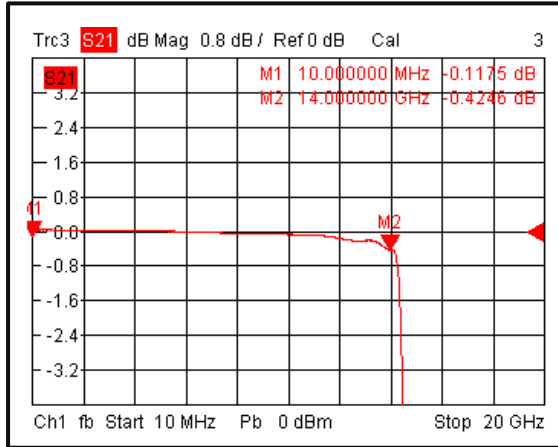

Input VSWR

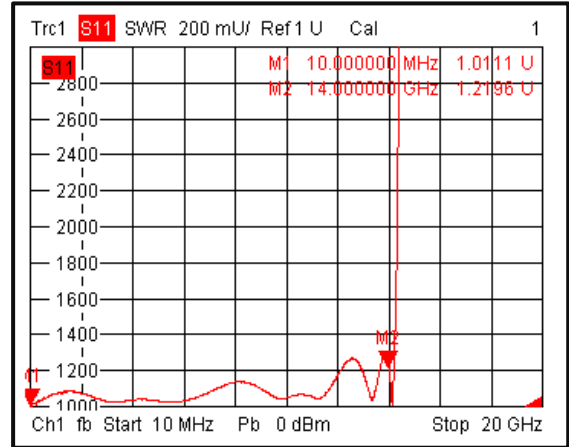

Output VSWR

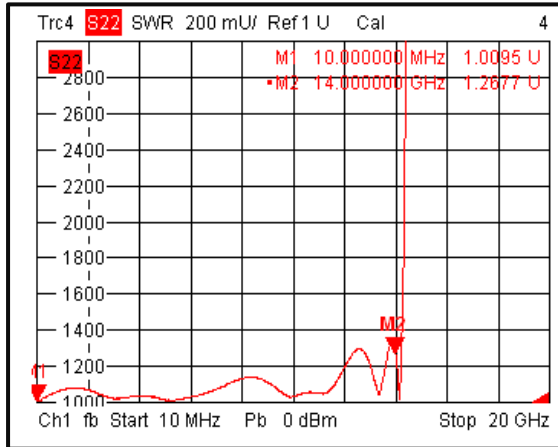

Rejection

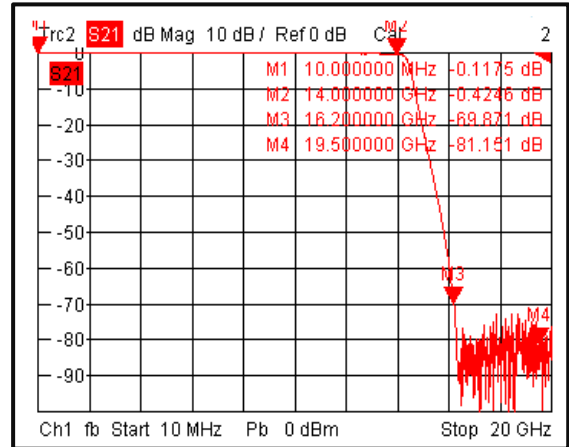

Outline Drawing

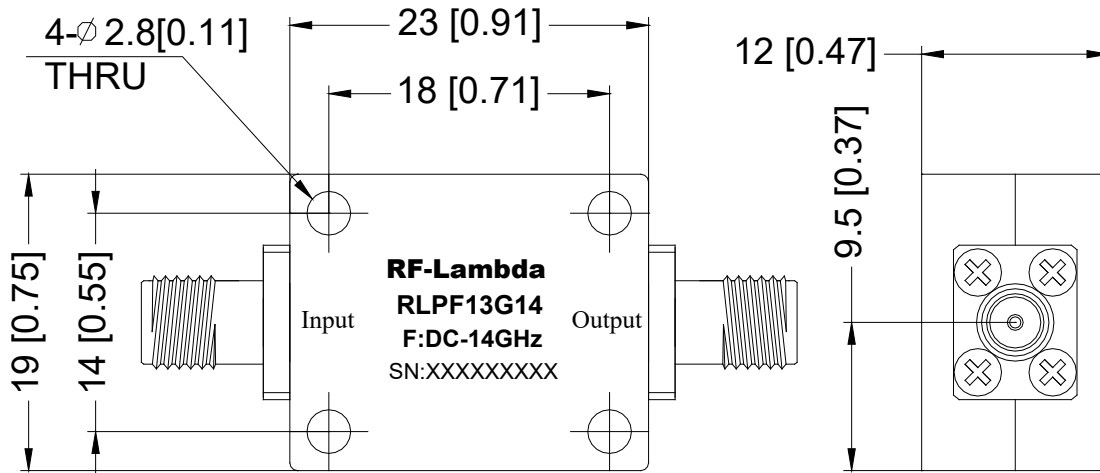

Notes:

1. Package Material: Aluminum
2. Finish: Blue Painted
3. All dimensions are in millimeters [inches].
4. Outline Tolerances ± 0.5 [0.02], Mounting Hole Tolerances ± 0.2 [0.008] unless otherwise specified.

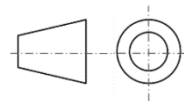

Additional Information

Documentation	Webpage
Connector Torque Specifications	https://www.rflambda.com/pdf/Torque_Specifications.pdf
Random Vibration Test Standard	https://www.rflambda.com/pdf/rflambda_random_vibration_MIL-STD-202G.pdf

Ordering Information

Part Number	Modification	Description
RLPF13G14	Standard	DC-14GHz SSS Low Pass Filter

Important Notice

The information contained herein is believed to be reliable. RF-Lambda makes no warranties regarding the information contained herein. RF-Lambda assumes no responsibility or liability whatsoever for any of the information contained herein. RF-Lambda assumes no responsibility or liability whatsoever for the use of the information contained herein. The information contained herein is provided "AS IS, WHERE IS" and with all faults, and the entire risk associated with such information is entirely with the user. All information contained herein is subject to change without notice. Customers should obtain and verify the latest relevant information before placing orders for RF-Lambda products. The information contained herein or any use of such information does not grant, explicitly or implicitly, to any party any patent rights, licenses, or any other intellectual property rights, whether with regard to such information itself or anything described by such information.

RF-Lambda products are not warranted or authorized for use as critical components in medical, life-saving, or life sustaining applications, or other applications where a failure would reasonably be expected to cause severe personal injury or death.