



300W 2.9-3.3GHz 40dB Dual Directional Coupler



Electrical Specifications

- High power handle capability up to 300W
- Wide band operation
- High isolation within operational band
- Low Insertion loss
- Low temperature coefficient material offer stable performance over temperature
- Aerospace and military application
- LMDS multi-carrier operation
- High peak to average handle capability
- All specifications can be modified upon request

Parameters		Min.	Typ.	Max.	Units
Frequency Range		2.8		3.4	GHz
Nominal Coupling		39	40	41	dB
Frequency Sensitivity			±0.2	±0.3	dB
Directivity		15	16		dB
Insertion Loss (Excl Coupling)			0.2	0.4	dB
VSWR Primary			1.15	1.2	
VSWR Secondary			1.15	1.2	
Power Rating	Average	300			W
	Peak	3			KW
Impedance		50			Ohms
Operating Temperature		-45 to +85			°C
Weight		/			ounces
Input / Output Connector		Input & Output: 7/16-Female		Coupled Port: N-Female	
Material		Aluminum			
Finishing		Gray Paint			

Environment specifications

Operational Temperature (°C)	-45 to +85
Storage Temperature (°C)	-55 to +125
Altitude	30,000 ft. (Epoxy Seal Controlled environment) 60,000 ft 1.0psi min (Hermetically Seal Un-controlled environment) (Optional)
Vibration	25g rms (15 degree 2KHz) endurance, 1 hour per axis
Humidity	100% RH at 35c, 95%RH at 40 deg c
Shock	20G for 11msc half sin wave, 3 axis both directions



Typical Performance Plots

Nominal Coupling 1

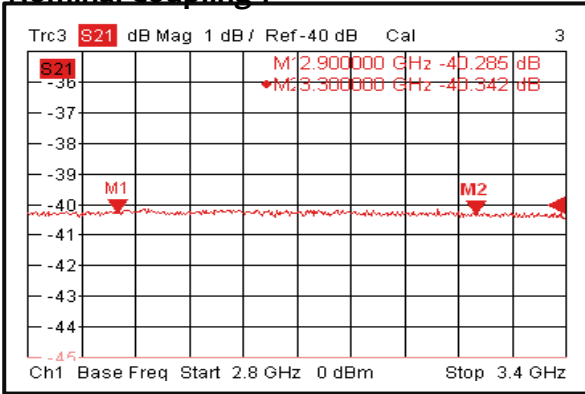

Nominal Coupling 2

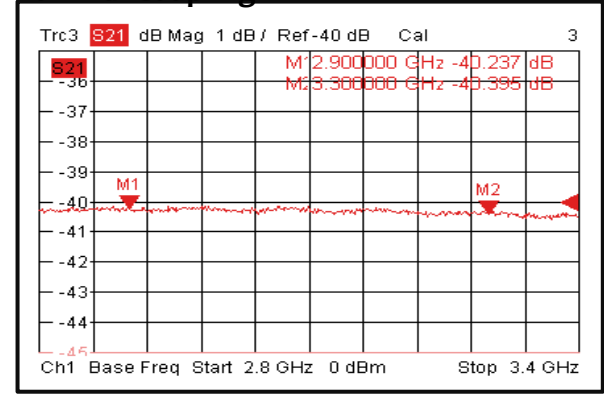

Primary VSWR 1

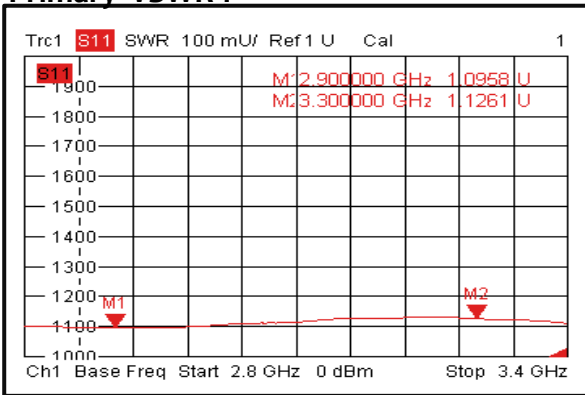

Primary VSWR 2

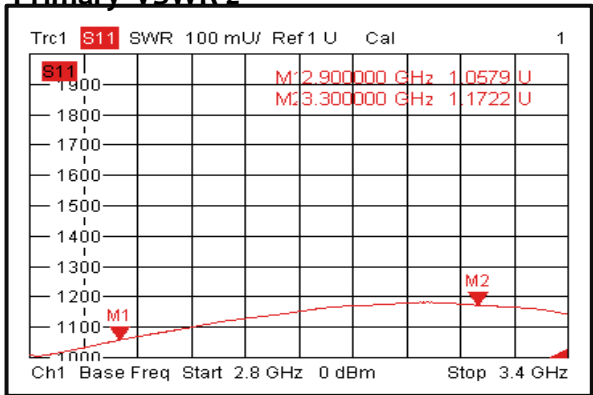

Secondary VSWR 1

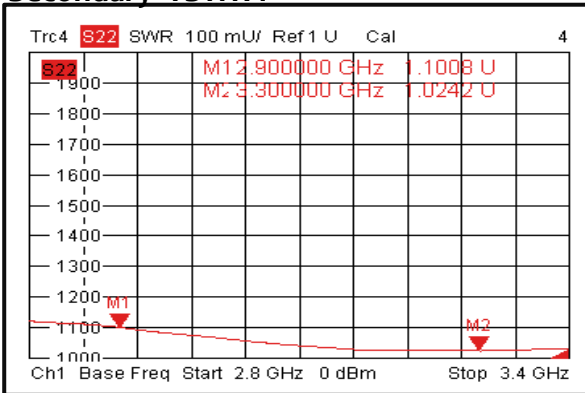

Secondary VSWR 2

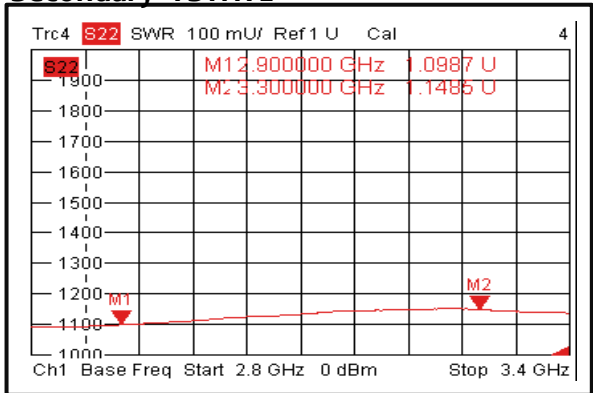

Directivity 1

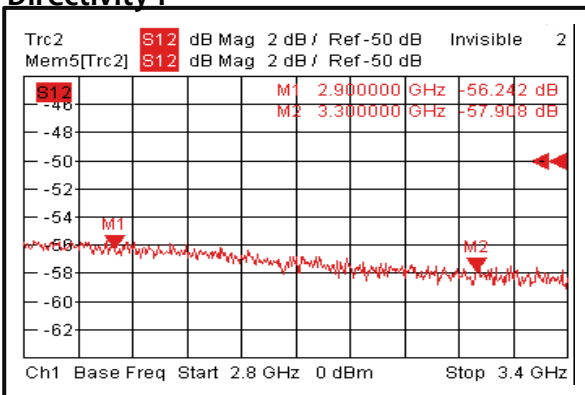

Directivity 2

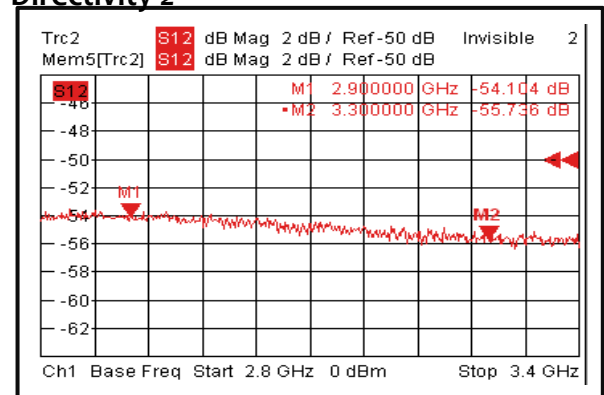



RF-LAMBDA

LEADER OF BROADBAND SOLUTIONS

RFDDC2G3G40D

Coaxial 300 W 2.9-3.3GHz 40dB Dual Directional Coupler

Insertion Loss

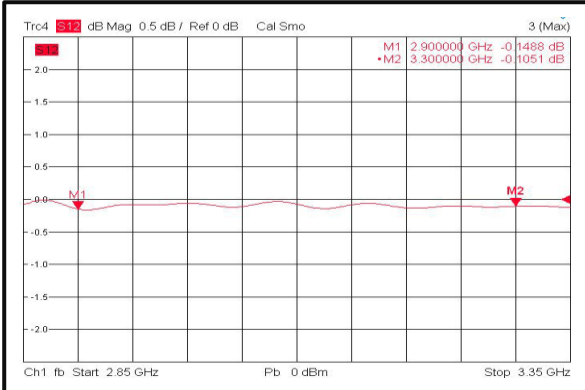

Outline Drawing:

All Dimensions in mm (inches)

Tolerance ± 0.2 (0.008)

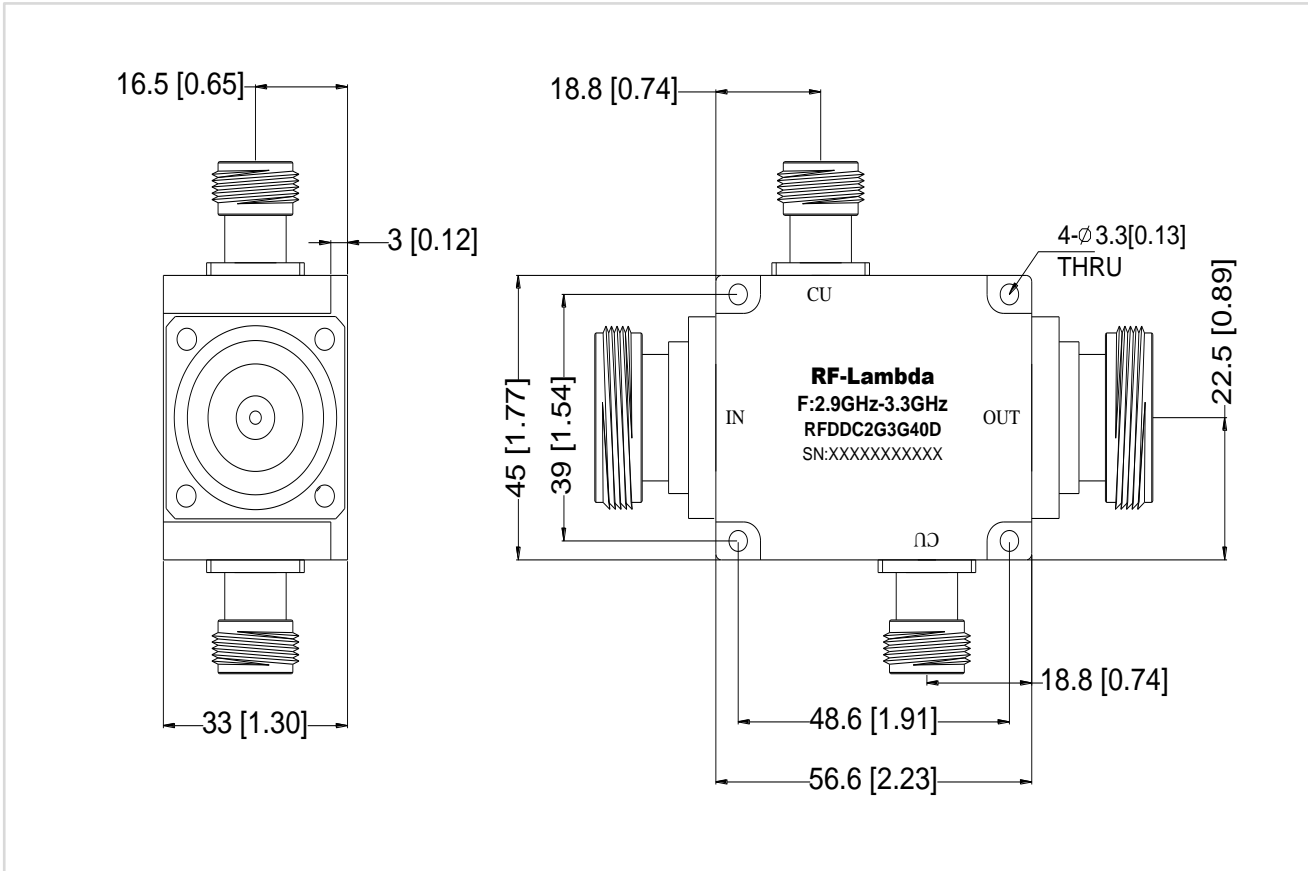

Important Notice

The information contained herein is believed to be reliable. RF-Lambda makes no warranties regarding the information contained herein. RF-Lambda assumes no responsibility or liability whatsoever for any of the information contained herein. RF-Lambda assumes no responsibility or liability whatsoever for the use of the information contained herein. The information contained herein is provided "AS IS, WHERE IS" and with all faults, and the entire risk associated with such information is entirely with the user. All information contained herein is subject to change without notice. Customers should obtain and verify the latest relevant information before placing orders for RF-Lambda products. The information contained herein or any use of such information does not grant, explicitly or implicitly, to any party any patent rights, licenses, or any other intellectual property rights, whether with regard to such information itself or anything described by such information.

RF-Lambda products are not warranted or authorized for use as critical components in medical, life-saving, or life sustaining applications, or other applications where a failure would reasonably be expected to cause severe personal injury or death.