

Coaxial 500W 20dB Directional Coupler 1GHz-2GHz



Product Description

RFDC1G2G20 is a coaxial directional coupler with a frequency range of 1 to 2GHz.

The power of this directional coupler is 500W. The insertion loss is 0.2dB with a typical directivity of 22dB.

The working temperature of this product is between - 40°C and + 85°C.

Features

- High power handling up to 500W
- Wide band operation
- High directivity within operational band
- Low Insertion Loss

Typical Applications

- Wireless Infrastructure
- Military and Aerospace Applications
- Test Instrumentation
- Radar Systems
- 5G Wireless Communications
- Microwave Radio Systems
- TR Modules
- Research and Development
- Cellular Base Stations

Electrical Specifications, TA = +25°C

Parameter	Min	Typ	Max	Units
Frequency Range	1		2	GHz
Nominal Coupling	19.2	20	20.8	dB
Frequency Sensitivity		±0.3	±0.5	dB
Directivity	20	22		dB
Insertion Loss (Excl. Coupling)			0.2	dB
Insertion Loss (True)		0.1	0.25	dB
VSWR Primary		1.1	1.2	: 1
VSWR Secondary		1.1	1.2	: 1
Power Rating	Average	500		W
	Peak	3 (10% Duty Cycle, 10us Pulse Width) 1.7 (20% Duty Cycle, 20us Pulse Width)		KW
Weight		1.15 Max.		lbs
Impedance		50		Ω
Input / Output Connectors	SMA-Female(Input) – SMA-Female(Output)			
Package	Epoxy Sealed (Standard)			
	Hermetically Sealed (Optional)			

Environmental Specifications and Test Standards

Parameter	Description
Operational Temperature	-40°C to +85°C (Case Temperature)
Storage Temperature	-50°C to +105°C
Thermal Shock	-40°C → +85°C (5 Cycles / 10 hours)
*Random Vibration	MIL-STD-202G Table 214-I, Test Condition Letter C 1.5 Hours Per Axis
Shock	1. Weight >20g, 50g half sine wave for 11ms, Speed variation 3.44m/s 2. Weight <=20g, 100g Half sine wave for 6ms, Speed variation 3.75m/s 3. Total 18 times (6 directions, 3 repetitions per direction).
Altitude	Standard: 30,000 Ft (Epoxy Sealed Controlled Environment) Optional: Hermetically Sealed (60,000 ft. 1.0 PSI min)
Hermetically Sealed (Optional)	MIL-STD-883 (For Hermetically Sealed Units)

*For vibration testing details please see additional information section.

Typical Performance Plots

Insertion Loss

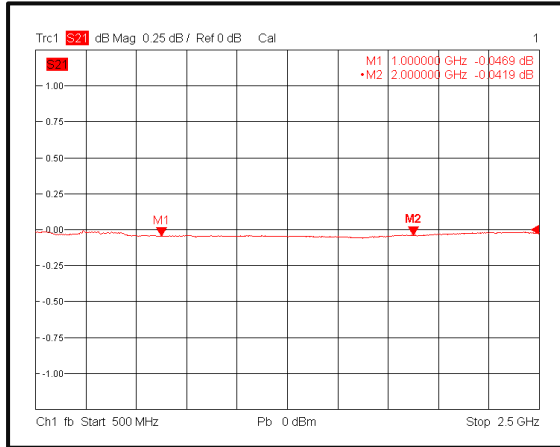

Primary VSWR

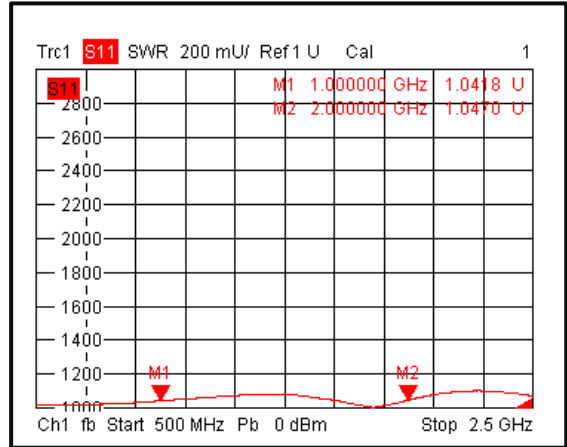

Secondary VSWR

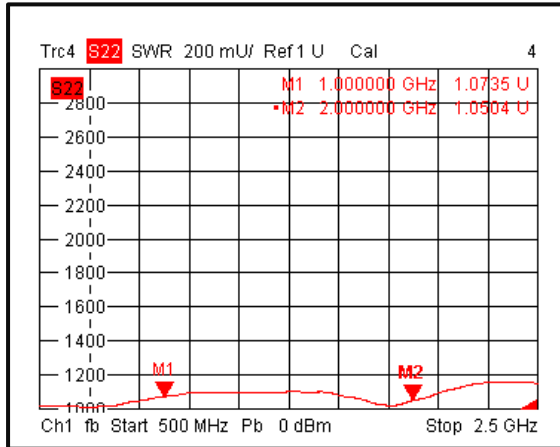

Directivity

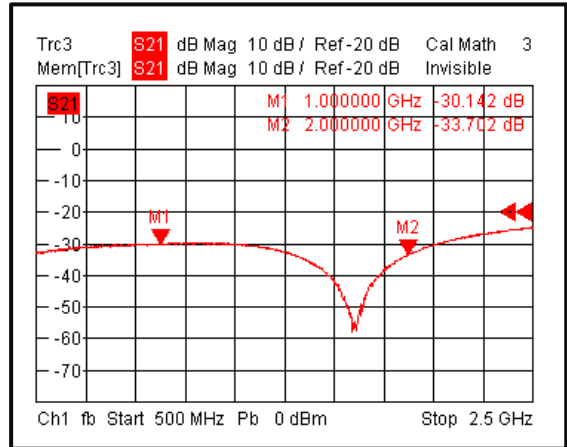

Nominal Coupling

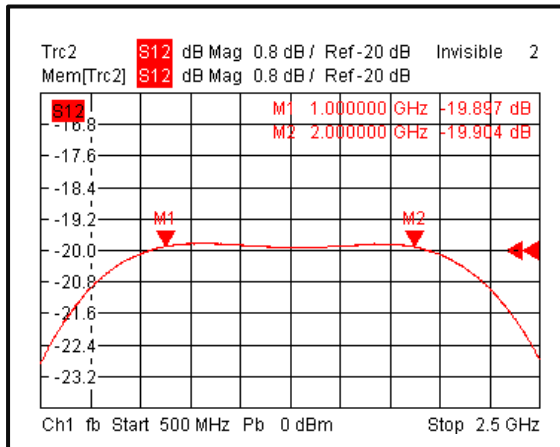

Outline Drawing

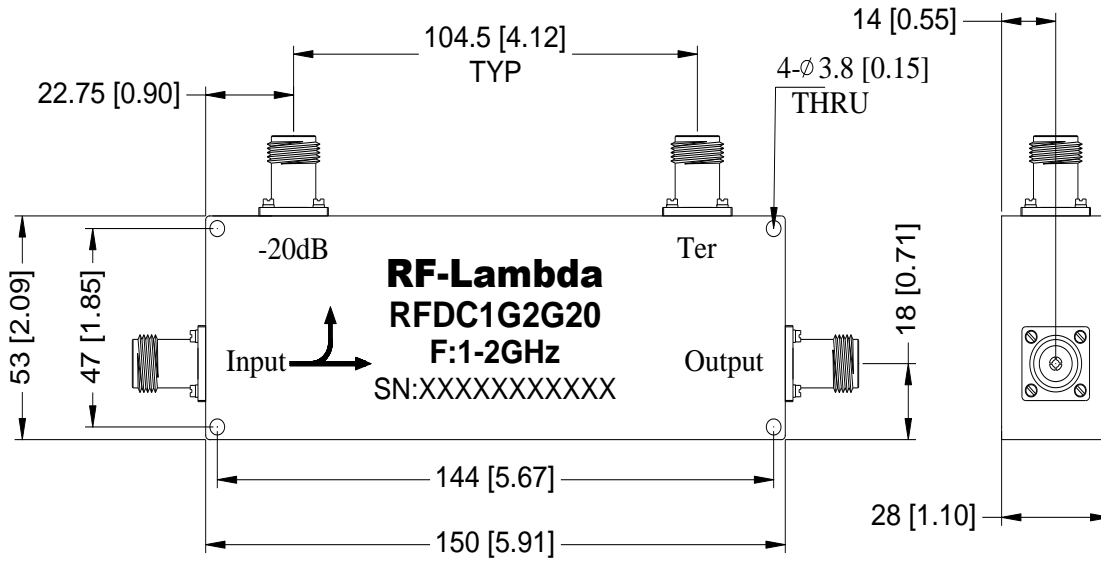

Notes:

1. Package Material: Aluminum
2. Finish: Blue Paint
3. All dimensions are in millimeters [inches].
4. Outline Tolerances ± 0.5 [0.02], Mounting Hole Tolerances ± 0.2 [0.008] unless otherwise specified.
5. Standard torque wrench must be used to secure RF connectors.

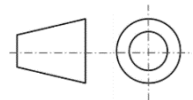

Additional Information

Documentation	Webpage
Connector Torque Specifications	https://www.rflambda.com/pdf/Torque_Specifications.pdf
Random Vibration Test Standard	https://www.rflambda.com/pdf/rflambda_random_vibration_MIL-STD-202G.pdf

Ordering Information

Part Number	Modification	Description
RFDC1G2G20	Standard	1GHz-2GHz Directional Coupler

Important Notice

The information contained herein is believed to be reliable. RF-Lambda makes no warranties regarding the information contained herein. RF-Lambda assumes no responsibility or liability whatsoever for any of the information contained herein. RF-Lambda assumes no responsibility or liability whatsoever for the use of the information contained herein. The information contained herein is provided "AS IS, WHERE IS" and with all faults, and the entire risk associated with such information is entirely with the user. All information contained herein is subject to change without notice. Customers should obtain and verify the latest relevant information before placing orders for RF-Lambda products. The information contained herein or any use of such information does not grant, explicitly or implicitly, to any party any patent rights, licenses, or any other intellectual property rights, whether with regard to such information itself or anything described by such information.

RF-Lambda products are not warranted or authorized for use as critical components in medical, life-saving, or life sustaining applications, or other applications where a failure would reasonably be expected to cause severe personal injury or death.