

Right Angel Adapter 3.5mm Female to 2.92mm Male DC - 33GHz



Features

- Wide band operation
- Low VSWR
- 50 Ohm Matched

Typical Applications

- Enables Between Series Connections
- Test and Measurement

Electrical Specifications, TA = +25 °C

Parameter	Min.	Typ.	Max.	Units
Frequency Range	DC		33	GHz
VSWR			1.25	: 1
Insertion Loss			0.29	dB
Impedance	50			Ohms
Connectors	3.5mm-Female/2.92mm-Male			
Material	Stainless Steel			
Surface Treatment	Passivated			
Center PIN	Beryllium Copper Gold Plated			
Insulate material	PEI			

Environmental Specifications and Test Standards

Parameter	Description
Operational Temperature	-55°C~+165°C
Storage Temperature	-60°C~+185°C
Thermal Shock	-55°C → +165°C (5 Cycles / 10 hours)
Random Vibration	MIL-STD-202G Table 214-I, Test Condition Letter C 1.5 Hours Per Axis
High Temperature Burn In	Temperature +85°C for 72 Hours
Shock	1. Weight >20g, 50g half sine wave for 11ms, Speed variation 3.44m/s 2. Weight <=20g, 100g Half sine wave for 6ms, Speed variation 3.75m/s 3. Total 18 times (6 directions, 3 repetitions per direction).
Altitude	Standard: 30,000 Ft (Epoxy Sealed Controlled Environment) Optional: Hermetically Sealed (60,000 ft. 1.0 PSI min)
Hermetically Sealed (Optional)	MIL-STD-883 (For Hermetically Sealed Units)

Right Angel Adapter 3.5mm Female to 2.92mm Male DC - 33GHz

Outline Drawing:

All Dimensions in mm [inches]

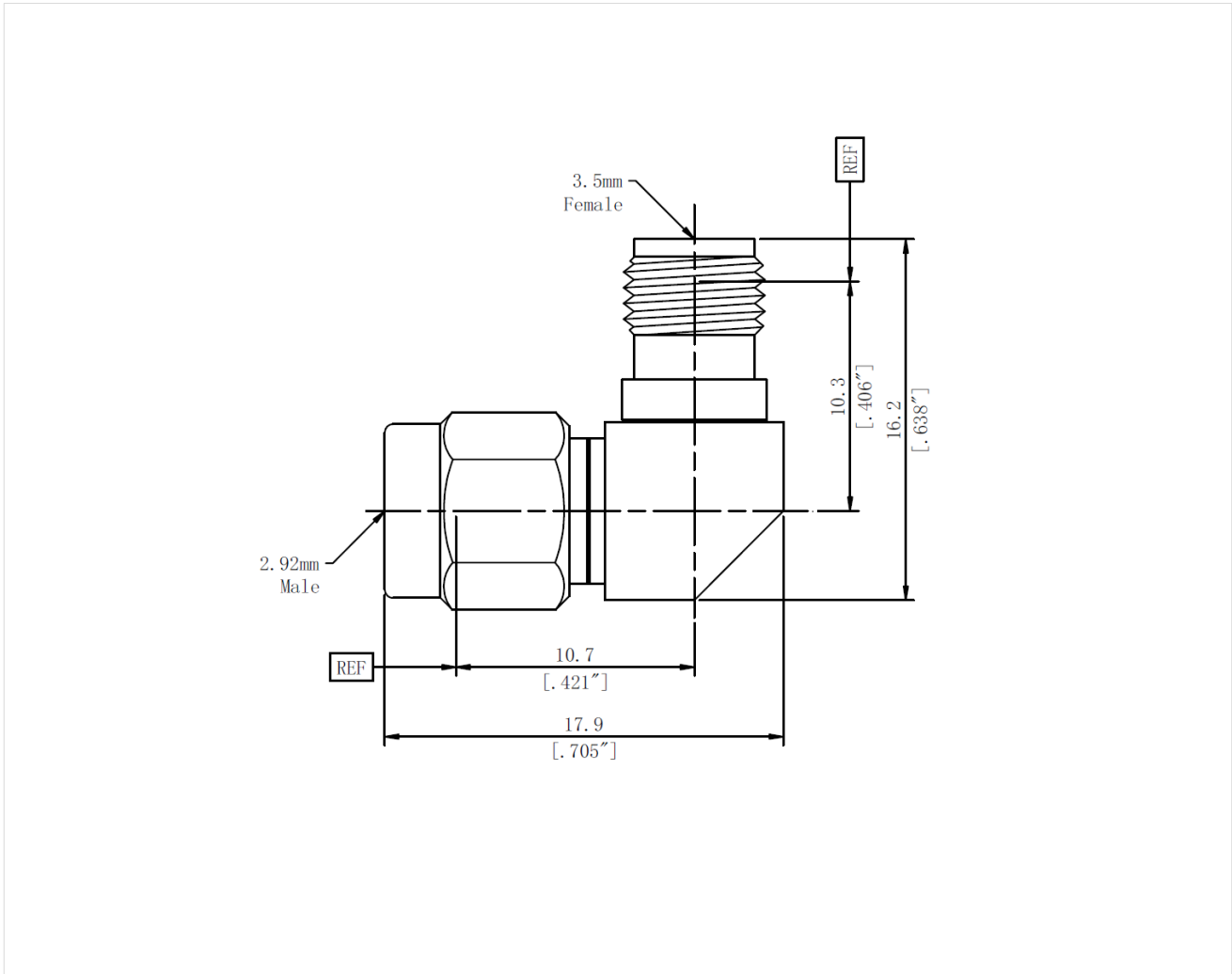

Important Notice

The information contained herein is believed to be reliable. RF-Lambda makes no warranties regarding the information contained herein. RF-Lambda assumes no responsibility or liability whatsoever for any of the information contained herein. RF-Lambda assumes no responsibility or liability whatsoever for the use of the information contained herein. The information contained herein is provided "AS IS, WHERE IS" and with all faults, and the entire risk associated with such information is entirely with the user. All information contained herein is subject to change without notice. Customers should obtain and verify the latest relevant information before placing orders for RF-Lambda products. The information contained herein or any use of such information does not grant, explicitly or implicitly, to any party any patent rights, licenses, or any other intellectual property rights, whether with regard to such information itself or anything described by such information. RF-Lambda products are not warranted or authorized for use as critical components in medical, life-saving, or life sustaining applications, or other applications where a failure would reasonably be expected to cause severe personal injury or death.

Right Angel Adapter 3.5mm Female to 2.92mm Male DC - 33GHz