



100W Wide Band High Power Circulator 360-440MHz



- High power handle capability up to 100W
- Wide band operation
- High isolation within operational band
- Low Insertion loss
- Low temperature coefficient ferrite material offer stable performance over temperature
- Aerospace and military application
- High peak to average handle capability
- All specifications can be modified upon request

Parameter	Min	Type	Max	Units
Frequency Range	360-440			MHz
Insertion Loss			0.6	dB
Isolation (Note 1)	17			dB
VSWR			1.35	:1
Forward Power (CW)			100	W
Reverse Power (CW)			100	W
Peak Power (CW) 5% 5us			400	W
Rotation	Counter Clockwise (Standard) Clockwise (upon request)			
Impedance	50			Ω
Input /Output Connector	Drop-in			
Finishing	Nickel plating			
Case Material	Aluminum alloy			
Operational Temp.	-40		85	°C
Storage Temp.	-55		95	°C
Altitude	15000		TBD	ft.
Vibration	10g 15 degree 2KHz			RMS
Humidity	100% RH at 35c, 95%RH at 40°C			
Shock	20G for 11msc.			

Note 1: Unit has narrow frequency bandwidth can achieve higher isolation & low insertion loss

Bandwidth (5 ~10) % x Center Frequency (Isolation >23dB)

Bandwidth (20~30) % x Center Frequency (Isolation >21dB)

Bandwidth (40~60) % x Center Frequency (Isolation >20dB)

Ask manufacture for detail

1000W Wide Band High Power Circulator 360-440MHz



RF-LAMBDA

The power beyond expectations

RFLC101M36M44

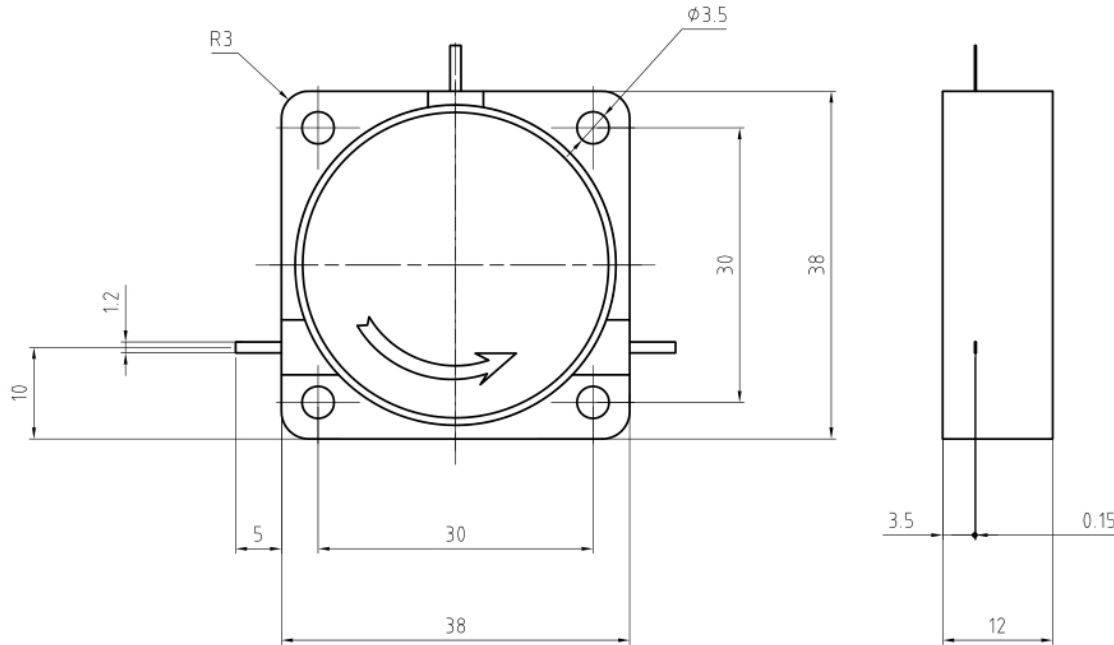

Important Notice

The information contained herein is believed to be reliable. RF-Lambda makes no warranties regarding the information contained herein. RF-Lambda assumes no responsibility or liability whatsoever for any of the information contained herein. RF-Lambda assumes no responsibility or liability whatsoever for the use of the information contained herein. The information contained herein is provided "AS IS, WHERE IS" and with all faults, and the entire risk associated with such information is entirely with the user. All information contained herein is subject to change without notice. Customers should obtain and verify the latest relevant information before placing orders for RF-Lambda products. The information contained herein or any use of such information does not grant, explicitly or implicitly, to any party any patent rights, licenses, or any other intellectual property rights, whether with regard to such information itself or anything described by such information.

RF-Lambda products are not warranted or authorized for use as critical components in medical, life-saving, or life sustaining applications, or other applications where a failure would reasonably be expected to cause severe personal injury or death.

1000W Wide Band High Power Circulator 360-440MHz