

Wide Band Coaxial Circulator 2GHz-4GHz



Product Description

RFLC-301-4N is a wide band coaxial circulator with a frequency range of 2 to 4GHz.

The circulator has a typical isolation of 18.5dB. The maximum insertion loss is 0.5dB. The circulator has good isolation performance.

The circulator input and output connectors are N Female.

Features

- High power handling up to 100W
- Wide band operation
- High isolation within operational band
- Low Insertion Loss
- Stable performance over temperature

Typical Applications

- Wireless Infrastructure
- Military and Aerospace Applications
- Test Instrumentation
- Radar Systems
- 5G Wireless Communications
- Microwave Radio Systems
- TR Modules
- Research and Development
- Cellular Base Stations

Electrical Specifications (T_A=+25°C)

Parameter	Min.	Typ.	Max.	Units
Frequency Range		2-4		GHz
Insertion Loss	@2-2.2GHz	0.6	1.1	dB
	@2.2-4GHz	0.5	0.6	
Isolation	18	18.5		dB
VSWR		1.3	1.35	:1
Power Handling			100	W
Rotation		Clockwise		
Input / Output Connectors		N-Female(Input) – N-Female(Output)		
Weight		0.24Max.		lbs
Impedance		50		Ω

Environmental Specifications and Test Standards

Parameter	Description
Operational Temperature	-20°C to +70°C (Case Temperature)
Storage Temperature	-40°C to +85°C
Thermal Shock	-40°C → +85°C (5 Cycles / 10 hours)
*Random Vibration	MIL-STD-202G Table 214-I, Test Condition Letter C 1.5 Hours Per Axis
Shock	1. Weight >20g, 50g half sine wave for 11ms, Speed variation 3.44m/s 2. Weight <=20g, 100g Half sine wave for 6ms, Speed variation 3.75m/s 3. Total 18 times (6 directions, 3 repetitions per direction).
Altitude	Standard: 30,000 Ft (Epoxy Sealed Controlled Environment) Optional: Hermetically Sealed (60,000 ft. 1.0 PSI min)
Hermetically Sealed (Optional)	MIL-STD-883 (For Hermetically Sealed Units)

*For vibration testing details please see additional information section.

Typical Performance Plots

Insertion Loss (Port 1-Port 2)

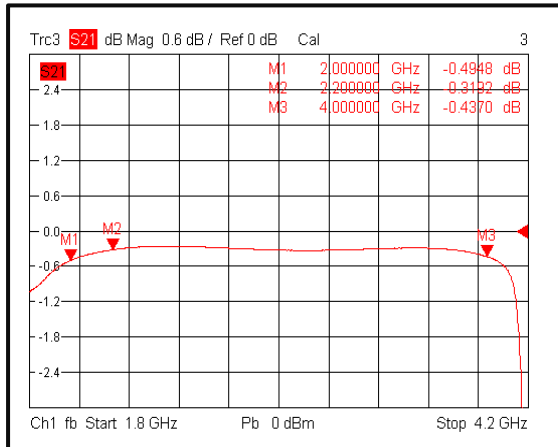

Insertion Loss (Port 2-Port 3)

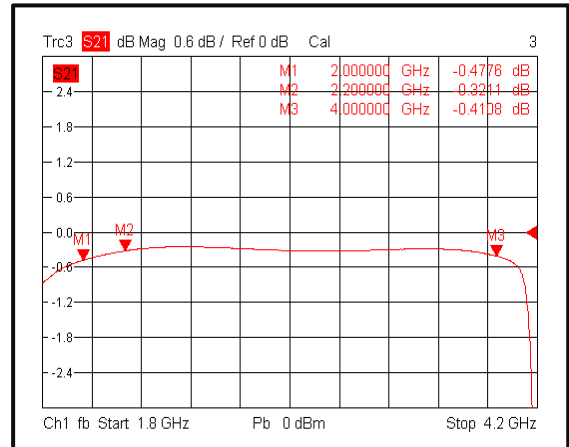

Insertion Loss (Port 3-Port 1)

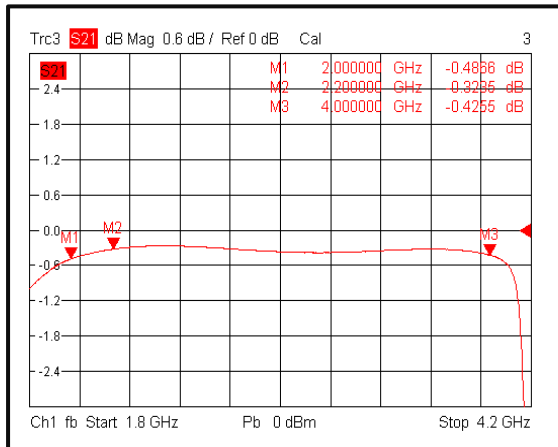

Isolation (Port 2-Port 1)

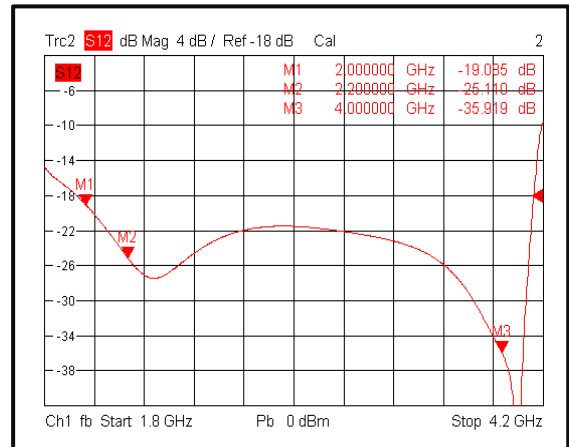

Isolation (Port 3-Port 2)

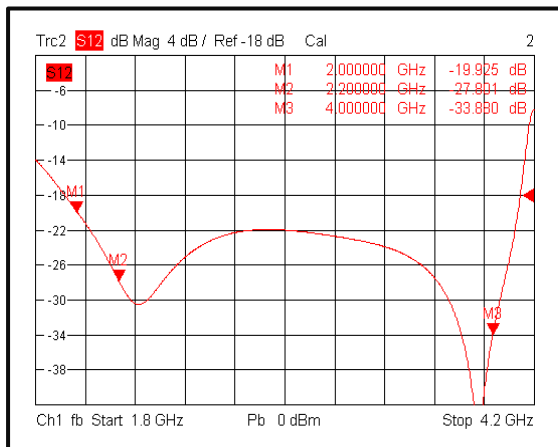

Isolation (Port 1-Port 3)

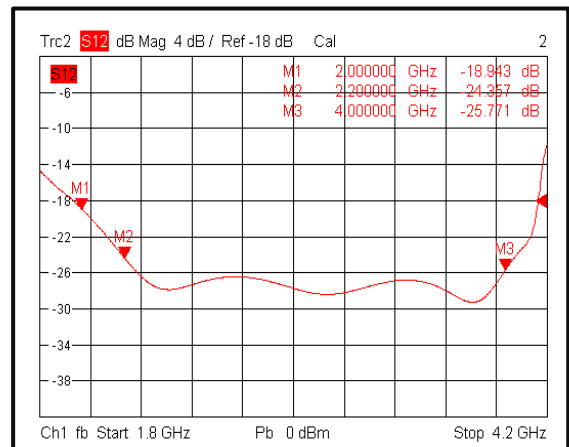

Typical Performance Plots

VSWR 1

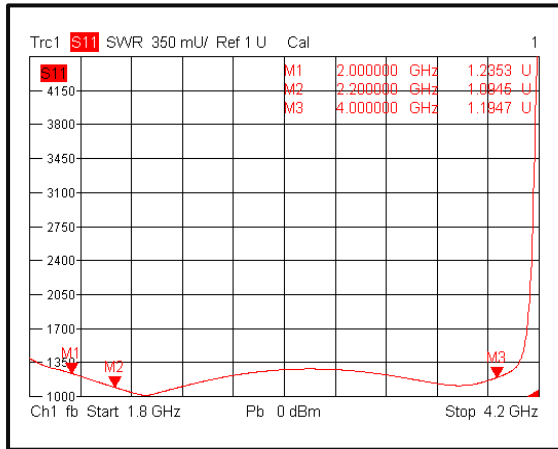

VSWR 2

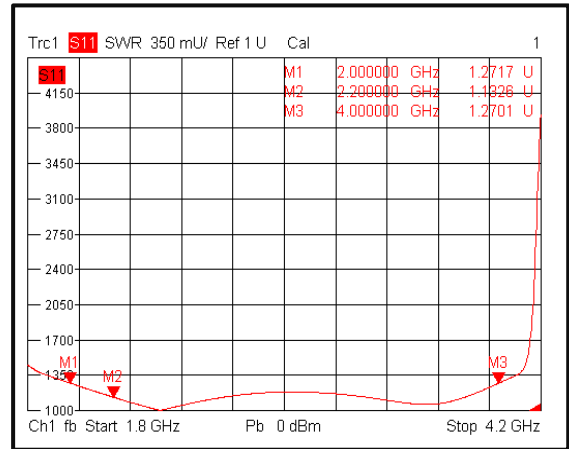

VSWR3

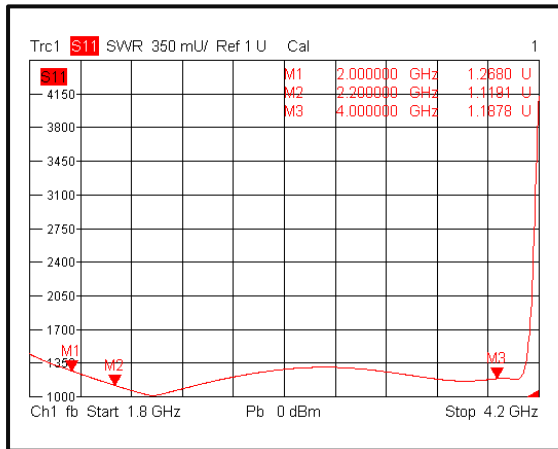

Outline Drawing

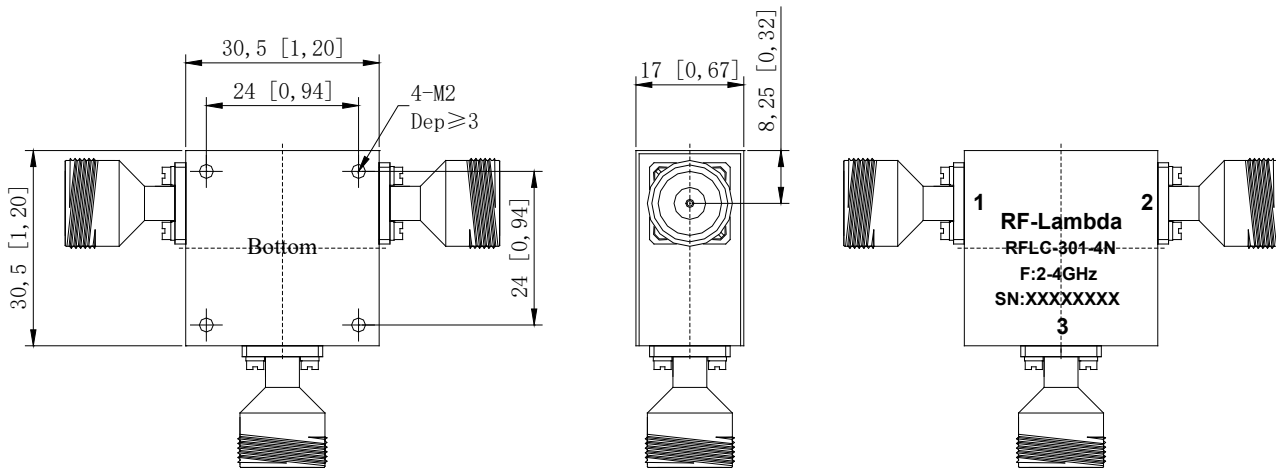

Notes:

1. Package Material: Aluminum Alloy
2. Plating: Nickel
3. All dimensions are in millimeters [inches].
4. Outline Tolerances ± 0.5 [0.02], Mounting Hole Tolerances ± 0.2 [0.008] unless otherwise specified.

Additional Information

Documentation	Webpage
ESD Policy	https://rflambda.com/pdf/rflambda_esd_control.pdf
Connector Torque Specifications	https://www.rflambda.com/pdf/Torque_Specifications.pdf
Random Vibration Test Standard	https://www.rflambda.com/pdf/rflambda_random_vibration_MIL-STD-202G.pdf

Ordering Information

Part Number	Modification	Description
RFLC-301-4N	Input Connector N-Female and Output Connector N-Female	2GHz-4GHz Coaxial Circulator

Important Notice

The information contained herein is believed to be reliable. RF-Lambda makes no warranties regarding the information contained herein. RF-Lambda assumes no responsibility or liability whatsoever for any of the information contained herein. RF-Lambda assumes no responsibility or liability whatsoever for the use of the information contained herein. The information contained herein is provided "AS IS, WHERE IS" and with all faults, and the entire risk associated with such information is entirely with the user. All information contained herein is subject to change without notice. Customers should obtain and verify the latest relevant information before placing orders for RF-Lambda products. The information contained herein or any use of such information does not grant, explicitly or implicitly, to any party any patent rights, licenses, or any other intellectual property rights, whether with regard to such information itself or anything described by such information. RF-Lambda products are not warranted or authorized for use as critical components in medical, life-saving, or life sustaining applications, or other applications where a failure would reasonably be expected to cause severe personal injury or death.