

Wideband 50W EMC Solid State Power Amplifier 33.5-37GHz



Note: Photo is for illustration purposes only.
Please refer to outline drawing.

Typical Applications

- Wireless Infrastructure
- Military and Aerospace Applications
- Test Instrumentation
- Radar Systems
- 5G Wireless Communications
- Microwave Radio Systems
- TR Modules
- Research and Development
- Cellular Base Stations

Product Description

REMC34G37GD is a wideband EMC power amplifier with wide frequency range of 33.5 to 37GHz.

Features

1. Small Signal Gain 63dB Typical
2. Digital Control Attenuator, 0.5db step
3. Psat 46.5dBm Typical
4. Power supply: single-phase VAC. Compatible for USA and EU standard.
5. 50 Ohm Matched Input/Output
6. Protection Functions:
 - Over temperature
 - Over current
 - Current imbalance
 - RF input over drive protection
 - VSWR protection
7. Amplifier Automatic Calibration Function
8. RF Output Power Display
9. RF Output Enable Function
10. High Maximum RF Input Power Handling, 10W max
11. Ethernet Remote Control
12. LCD Front Panel Display Screen

Electrical Specifications (T_A=+25°C)

| Parameter | Min | Typ | Max | Units |
|---|-----|---|-----|-------|
| Frequency Range | | 33.5 – 37 | | GHz |
| Small Signal Gain | | 63 | | dB |
| Gain Variance | | +/-5 | | dB |
| Gain Variation Over Temperature (0°C to +50°C) | | +/-3 | | dB |
| Input Return Loss | | -15 | | dB |
| Saturated Output Power (Psat) | | 46.5 | | dBm |
| Supply Current (single-phase 120VAC) | | / | | A |
| IM3 | | -30 | | dBc |
| RF ON and OFF Speed. (Gate/Drian control through d-sub connector) | | 10 | | ms |
| Power Added Efficiency (PAE) | | 20 | | % |
| Time Division Duplexing (TDD) Blanking (RF switch control through d-sub connector) | ON | 100 | | ns |
| | OFF | 100 | | ns |
| Weight | | 43 | | lbs. |
| Impedance | | 50 | | Ohms |
| Input / Output Connectors | | 2.92mm-Female(Input)-WR28 (Output) | | |
| Package | | Please reference the mechanical drawing | | |

Absolute Maximum Ratings

| Parameter | Rating |
|------------------------|--------------------------|
| Supply Voltage | 110VAC/220VAC |
| *RF Input Power (RFIN) | Psat – Large Signal Gain |

Bias Up Procedure

1. Connect input and output with 50 Ohm source/load. (In band VSWR < 1.9:1 or >10dB return loss.)
2. Connect Power Cable
3. Turn On Back Panel AC Power Supply Air Breaker
4. Press Front Panel Power Switch to Power Display

Bias Down Procedure

1. Press Front Panel Power Switch to Power Off Display
2. Turn Off Back Panel AC Power Supply Breaker
3. Remove Power Cable (If Moving Equipment)
4. Disconnect input and output with 50 Ohm source/load. (In band VSWR < 1.9:1 or >10dB return loss.)

Environmental Specifications and Test Standards

| Parameter | Description |
|--------------------------------|---|
| Operational Temperature | 0°C to +50°C (Ambient Temperature) |
| Storage Temperature | 0°C to +125°C |
| Thermal Shock | -40°C → +85°C (5 Cycles / 10 hours, Only internal modules tested prior to final assembly) |
| **Random Vibration | MIL-STD-202G Table 214-I, Test Condition Letter C 1.5 Hours Per Axis |
| High Temperature Burn In | Temperature 85°C for 72 Hours (Only internal modules tested prior to final assembly) |
| Shock | 1. Weight >20g, 50g half sine wave for 11ms, Speed variation 3.44m/s 2. Weight <=20g, 100g Half sine wave for 6ms, Speed variation 3.75m/s 3. Total 18 times (6 directions, 3 repetitions per direction). |
| Altitude | Standard: 30,000 Ft (Epoxy Sealed Controlled Environment) Optional: Hermetically Sealed (60,000 ft. 1.0 PSI min) |
| Hermetically Sealed (Optional) | MIL-STD-883 (For Hermetically Sealed Units) |

*Maximum RF input power is set to assure safety of amplifier. Input power may be increased at own risk to achieve full power of amplifier. Please reference gain and power curves.

**For vibration testing details please see additional information section.

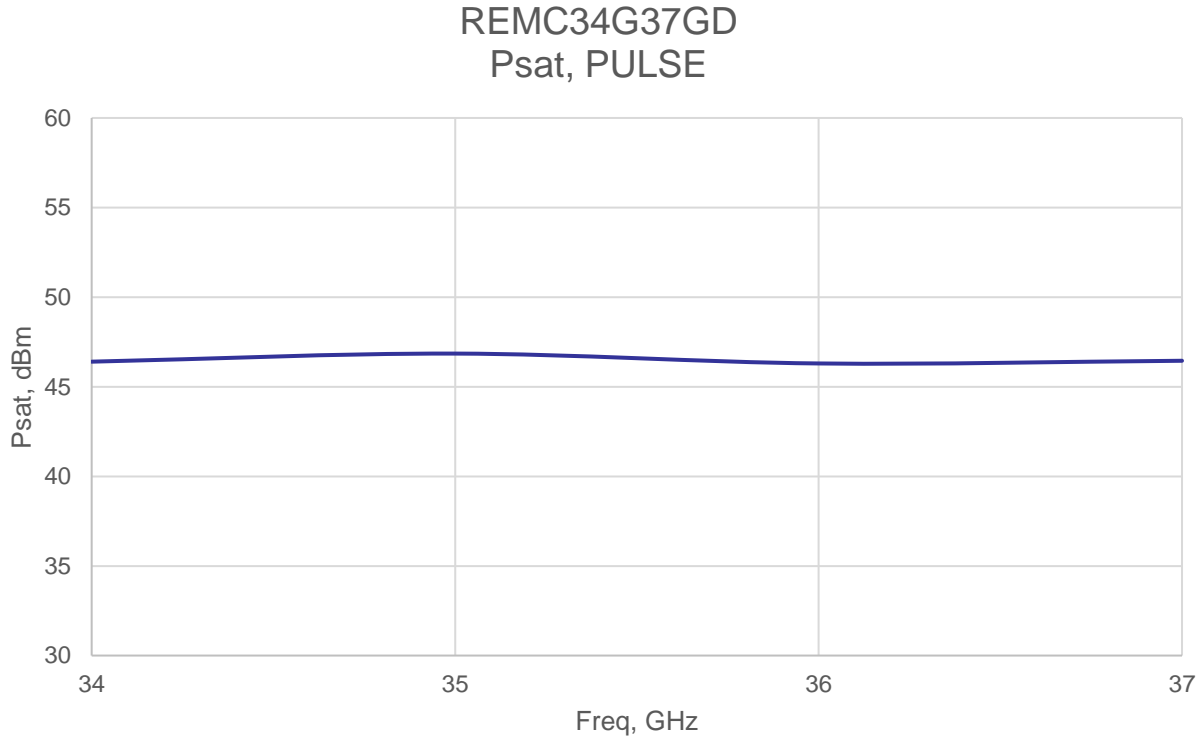

EMC Equipment Specifications

FRONT PANEL

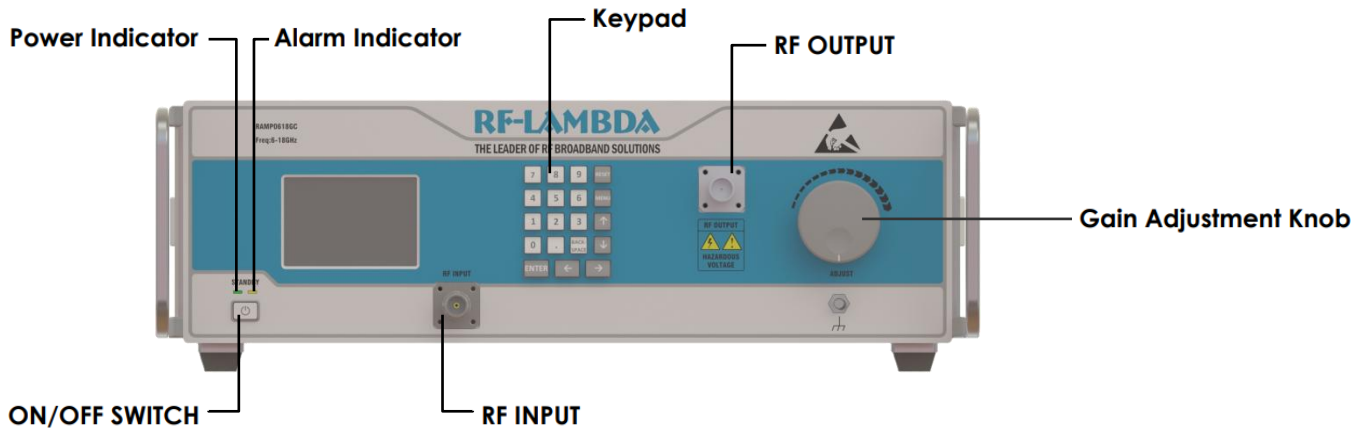

REAR PANEL

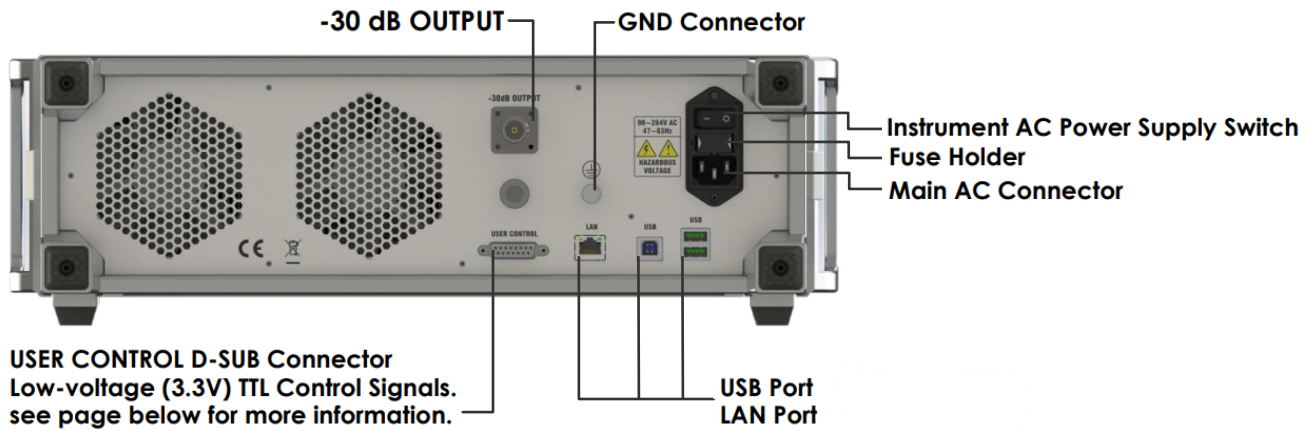

Front Panel LCD Screen Display

Switching On The Instrument



Please follow the instructions on the front panel LCD screen after switching on the power. Press "1" on keypad to continue.

Self Calibration Screen

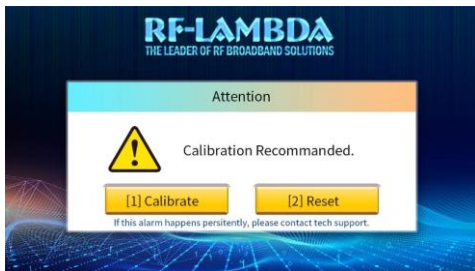

Calibration is may be recommended. "[1] Calibrate" to execute instrument self calibration process.

"[2] Reset" to reboot the instrument.

*Please connect input and output with 50 Ohm source/load.

Instrument Protection Alarms



The front panel LCD screen will display the error code or error message when instrument self protection is triggered. Front panel alarm indicator will light up.

To eliminate the error code, press "RESET" on front panel keypad to reboot the instrument and clear the alarms.

If error code can not be eliminated after reboot, please contact support@rflambda.com

Front Panel LCD Screen Function

Instrument Status Display Page

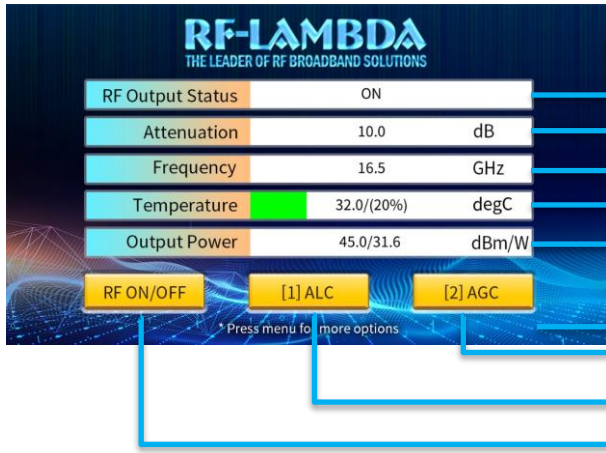

- Indicates instrument RF output status. It will display: ON or OFF
- RF output attenuation (change with adjustment knob)
- RF input signal frequency
- Instrument temperature
- Instrument RF output power
- Press "Menu" on keypad to enter instrument functions selection menu
- AGC mode, this function is invalid
- ALC mode, power lock
- Switches On or Off for instrument RF output port

Instrument Function Selection Page



- To enter this function selection page, press "Menu" on front panel keypad while the instrument is showing the status page. Press the corresponding number on front panel keypad to select:
- "[1] **Calibrate**" Calibrates the instruments
 - "[2] **Frequency**" Enters RF input signal frequency
 - "[3] **RF ON/OFF**" Switches the RF output port on or off
 - "[4] **Reset**" Restarts the instrument
 - "[5] **IP Set**" Enters IP display page
 - "[6] **Product Info**" Displays product information

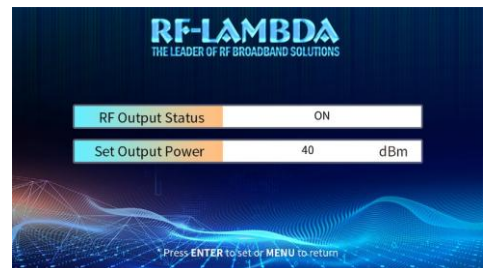
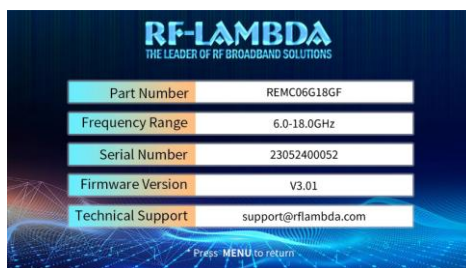
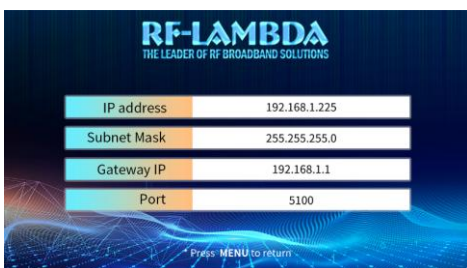
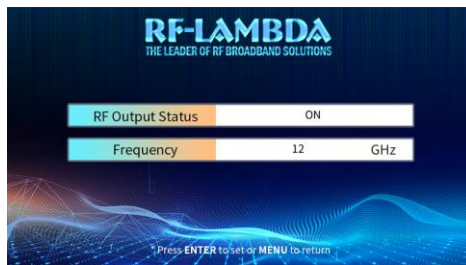

All action functions will ask for confirming execution when selected from function selection menu.

Protection Connector Table

Female D-Sub is on the housing
The mating male part number: 172-E15-203R001

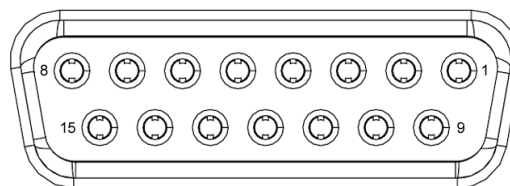

| Pin # | Name | Function | Initial State | Description | Applied |
|-------|------------------|--------------|---------------|--|---------|
| 1 | Reset | Control | | Resets PA when logic <u>LOW</u> is applied and released | Yes |
| 2 | Gate Disable | Control | LOW | Applying logic <u>HIGH</u> disables gate of amplifiers | Yes |
| 3 | Drain Disable | Control | LOW | Applying logic <u>HIGH</u> disables drain of amplifiers | Yes |
| 4 | RF IN Over | Indicator | LOW | Pin will be latched to logic <u>HIGH</u> when input signal is over limit | Yes |
| 5 | Temp Over | Indicator | LOW | Pin will be latched to logic <u>HIGH</u> when amplifier is driven over temperature | Yes |
| 6 | Current Over | Indicator | LOW | Pin will be latched to logic <u>HIGH</u> when drain current limit is reached | Yes |
| 7 | ID Imbalance | Indicator | LOW | Pin will be latched to logic <u>HIGH</u> when an imbalance in the drain current of the combining branches occurs | Yes |
| 8 | PA Off Alarm | Indicator | LOW | Pin will be latched to logic <u>HIGH</u> when any of the protection limit is reached | NO |
| 9 | Fan Alarm | Indicator | LOW | Pin will be latched to logic <u>HIGH</u> when Fan limit is reached | Yes |
| 10 | RF Switch OFF | Control | LOW | Applying logic <u>HIGH</u> turns RF switch to load path | Yes |
| 11 | VSWR | Indicator | LOW | Pin will be latched to logic <u>HIGH</u> when output reflection is over limit | Yes |
| 12 | 5dB Attenuation | Control | LOW | Applying logic <u>HIGH</u> enables 5dB attenuation | NO |
| 13 | 10dB Attenuation | Control | LOW | Applying logic <u>HIGH</u> enables 10dB attenuation | NO |
| 14 | +5V | Power Supply | +5V | +5V DC is available for reference 400mA current ability | Yes |
| 15 | GND | Ground | GND | Ground | Yes |

Notes:

- HIGH/LOW voltages are standard TTL signals 0.0V-0.8V = LOW. 2V-5V = HIGH. Input current is 10uA.
- Matching connector and cable will be shipped with the product.
- Applied=Yes means the feature is included. Applied=No means the feature is not included with this model.
- 5V reference supply can source 700mA.
- Indicator output signals can source 24mA.

Outline Drawing

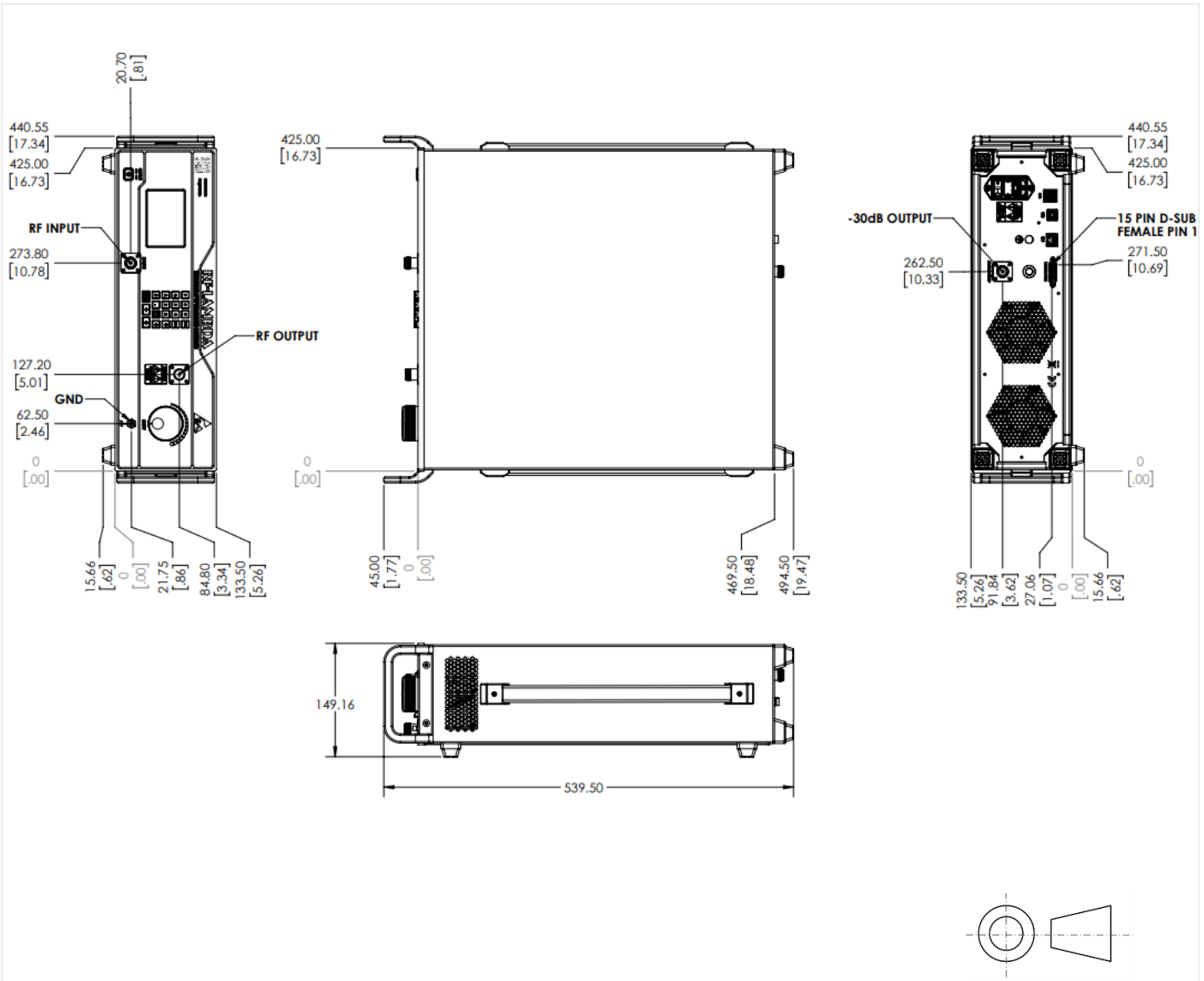

Notes:

1. All dimensions are in millimeters [inches].
2. Tolerances ± 3.0 [0.118] unless otherwise specified.



Additional Information

| Documentation | Webpage |
|---------------------------------|---|
| ESD Policy | https://rflambda.com/pdf/rflambda_esd_control.pdf |
| Heatsink Lookup Specifications | https://rflambda.com/search_heatsink.jsp |
| Connector Torque Specifications | https://www.rflambda.com/pdf/Torque_Specifications.pdf |
| Random Vibration Test Standard | https://www.rflambda.com/pdf/rflambda_random_vibration_MIL-STD-202G.pdf |

Ordering Information

| Part Number | Modification | Description |
|-------------|--|--|
| REMC34G37GD | Input connector SMA-Female and Output connector WR28 | 33.5GHz-37GHz EMC Benchtop Power Amplifier |



Each amplifier is shipped in a well protected package.

Amplifier Use

Ensure that the amplifier input and output ports are safely terminated into a proper 50 ohm load before turning on the power. Never operate the amplifier without a load. A proper 50 ohm load is defined as a load with impedance less than 1.9:1 or return loss larger than 10dB relative to 50 Ohm within the specified operating band width.

Power Supply Requirements

Power supply must be able to provide adequate current for the amplifier. Power supply should be able to provide 1.5 times the typical current or 1.2 times the maximum current (whichever is greater).

In most cases, RF - Lambda amplifiers will withstand severe mismatches without damage. However, operation with poor loads is discouraged. If prolonged operation with poor or unknown loads is expected, an external device such as an isolator or circulator should be used to protect the amplifier.

Ensure that the power is off when connecting or disconnecting the input or output of the amp.

Prevent overdriving the amplifier. Do not exceed the recommended input power level.

Adequate heat-sinking required for RF amplifier modules. Please inquire.

Amplifiers do not contain Thermal protection, Reverse DC polarity or Over voltage protection with the exception of a few models. Please inquire.

Proper electrostatic discharge (ESD) precautions are recommended to avoid performance degradation or loss of functionality.

What is not covered with warranty?

Each RF - Lambda amplifier will go through power and temperature stress testing.

Since the die, ICs or MMICs are fragile, these are not covered by warranty. Any damage to these will NOT be free to repair.

Important Notice

The information contained herein is believed to be reliable. RF-Lambda makes no warranties regarding the information contained herein. RF-Lambda assumes no responsibility or liability whatsoever for any of the information contained herein. RF-Lambda assumes no responsibility or liability whatsoever for the use of the information contained herein. The information contained herein is provided "AS IS, WHERE IS" and with all faults, and the entire risk associated with such information is entirely with the user. All information contained herein is subject to change without notice. Customers should obtain and verify the latest relevant information before placing orders for RF-Lambda products. The information contained herein or any use of such information does not grant, explicitly or implicitly, to any party any patent rights, licenses, or any other intellectual property rights, whether with regard to such information itself or anything described by such information.

RF-Lambda products are not warranted or authorized for use as critical components in medical, life-saving, or life sustaining applications, or other applications where a failure would reasonably be expected to cause severe personal injury or death.