

Wideband 400W EMC Solid State Power Amplifier 13-15.5GHz



Note: Photo is for illustration purposes only.
Please refer to outline drawing.

Typical Applications

- Wireless Infrastructure
- Military and Aerospace Applications
- Test Instrumentation
- Radar Systems
- 5G Wireless Communications
- Microwave Radio Systems
- TR Modules
- Research and Development
- Cellular Base Stations

Product Description

REMC13G16GE is a wideband EMC power amplifier with wide frequency range of 13 to 15.5GHz.

Features

1. Small Signal Gain 65dB Typical
2. Digital Control Attenuator 0.5db step
3. Psat 56dBm Typical
4. Power supply: single phase VAC. Compatible for USA and EU standard.
5. 50 Ohm Matched Input/Output
6. Protection Functions:
 - Over temperature
 - Over current
 - Current imbalance
 - RF input over drive protection
 - VSWR protection
7. Amplifier Automatic Calibration Function
8. RF Output Power Display
9. RF Output Enable Function
10. High Maximum RF Input Power Handling, 20W max
11. Ethernet Remote Control
12. LCD Front Panel Display Screen

Electrical Specifications (T_A=+25°C)

Parameter	Min	Typ	Max	Units
Frequency Range		13 - 15.5		GHz
Small Signal Gain		65		dB
Gain Variance		+/-5		dB
Gain Variation Over Temperature (0°C to +50°C)		+/-3		dB
Input Return Loss		-15		dB
Saturated Output Power (Psat)		56		dBm
Supply Current (single phase 110VAC)		/		A
IM3		-40		dBc
RF ON and OFF Speed. (Gate/Drive control through d-sub connector)		10		ms
Power Added Efficiency (PAE)		20		%
Time Division Duplexing (TDD) Blanking (RF switch control through d-sub connector)	ON	100		ns
	OFF	100		ns
Weight		60		lbs.
Impedance		50		Ohms
Input / Output Connectors	SMA-Female (Input) / WR62 (Output)			
Package	4U Rack-mount/Tabletop Chassis			

Absolute Maximum Ratings

Parameter	Rating
Supply Voltage	110V/220VAC
*RF Input Power (RFIN)	Psat – Large Signal Gain

Bias Up Procedure

1. Connect input and output with 50 Ohm source/load. (In band VSWR < 1.9:1 or >10dB return loss.)
2. Connect Power Cable
3. Turn On Back Panel AC Power Supply Air Breaker
4. Press Front Panel Power Switch to Power Display

Bias Down Procedure

1. Press Front Panel Power Switch to Power Off Display
2. Turn Off Back Panel AC Power Supply Breaker
3. Remove Power Cable (If Moving Equipment)
4. Disconnect input and output with 50 Ohm source/load. (In band VSWR < 1.9:1 or >10dB return loss.)

Environmental Specifications and Test Standards

Parameter	Description
Operational Temperature	0°C to +50°C (Ambient Temperature)
Storage Temperature	0°C to +125°C
Thermal Shock	-40°C → +85°C (5 Cycles / 10 hours, Only internal modules tested prior to final assembly)
**Random Vibration	MIL-STD-202G Table 214-I, Test Condition Letter C 1.5 Hours Per Axis
High Temperature Burn In	Temperature 85°C for 72 Hours (Only internal modules tested prior to final assembly)
Shock	1. Weight >20g, 50g half sine wave for 11ms, Speed variation 3.44m/s 2. Weight <=20g, 100g Half sine wave for 6ms, Speed variation 3.75m/s 3. Total 18 times (6 directions, 3 repetitions per direction).
Altitude	Standard: 30,000 Ft (Epoxy Sealed Controlled Environment) Optional: Hermetically Sealed (60,000 ft. 1.0 PSI min)
Hermetically Sealed (Optional)	MIL-STD-883 (For Hermetically Sealed Units)

*Maximum RF input power is set to assure safety of amplifier. Input power may be increased at own risk to achieve full power of amplifier. Please reference gain and power curves.

**For vibration testing details please see additional information section.

REMC13G16GE
Psat vs. Freq

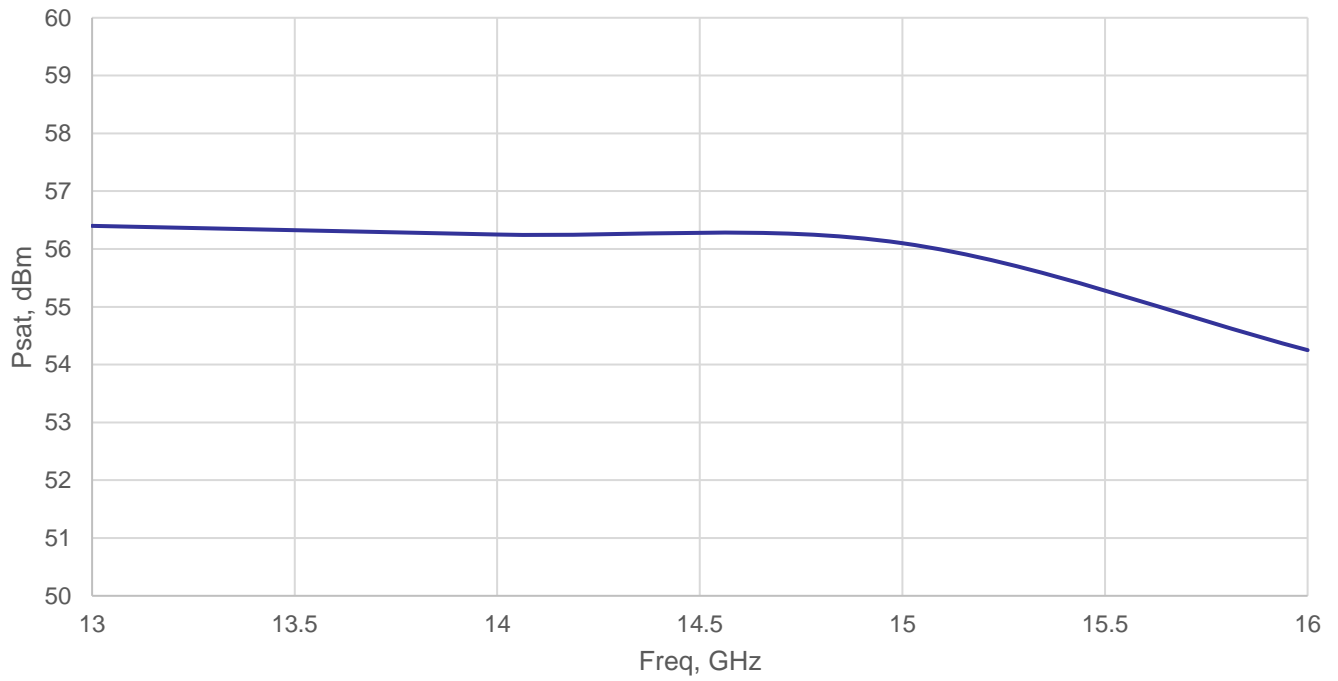

Front Panel LCD Screen Display

Switching On The Instrument



Please follow the instructions on the front panel LCD screen after switching on the power. Press "1" on keypad to continue.

Self Calibration Screen



Calibration is may be recommended. "[1] Calibrate" to execute instrument self calibration process.

"[2] Reset" to reboot the instrument.

*Please connect input and output with 50 Ohm source/load.

Instrument Protection Alarms



The front panel LCD screen will display the error code or error message when instrument self protection is triggered. Front panel alarm indicator will light up.

To eliminate the error code, press "RESET" on front panel keypad to reboot the instrument and clear the alarms.

If error code can not be eliminated after reboot, please contact support@rflambda.com

EMC Equipment Specifications

Front Panel



Rear Panel

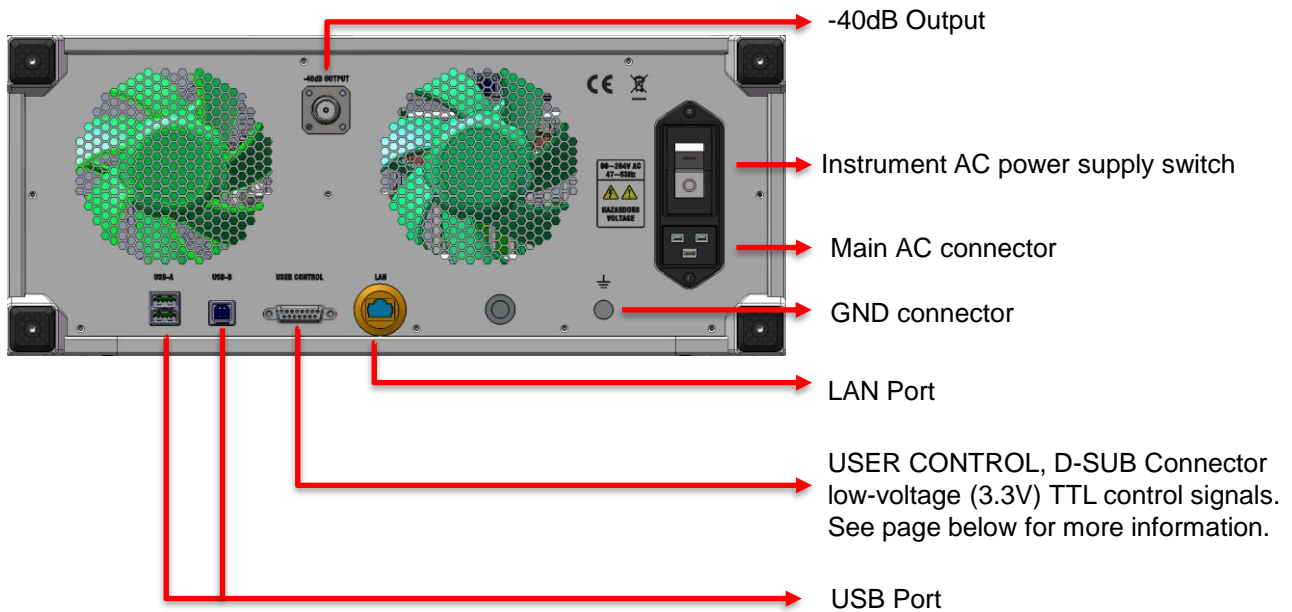

Front Panel LCD Screen Function

Instrument Status Display Page

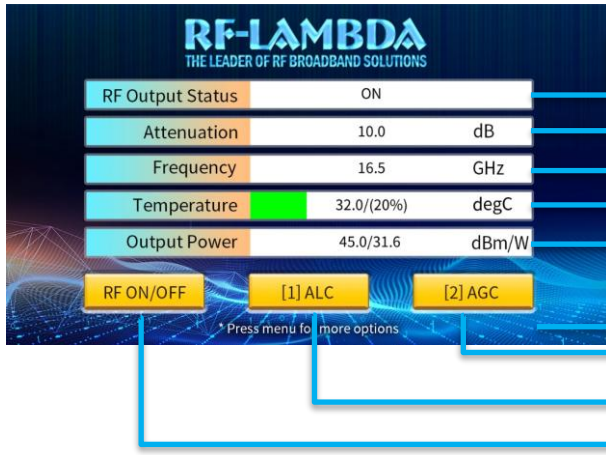

- Indicates instrument RF output status. It will display: ON or OFF
- RF output attenuation (change with adjustment knob)
- RF input signal frequency
- Instrument temperature
- Instrument RF output power
- Press "Menu" on keypad to enter instrument functions selection menu
- AGC mode, this function is invalid
- ALC mode, power lock
- Switches On or Off for instrument RF output port

Instrument Function Selection Page



To enter this function selection page, press "Menu" on front panel keypad while the instrument is showing the status page.

Press the corresponding number on front panel keypad to select:

- "[1] Calibrate" Calibrates the instruments
- "[2] Frequency" Enters RF input signal frequency
- "[3] RF ON/OFF" Switches the RF output port on or off
- "[4] Reset" Restarts the instrument
- "[5] IP Set" Enters IP display page
- "[6] Product Info" Displays product information

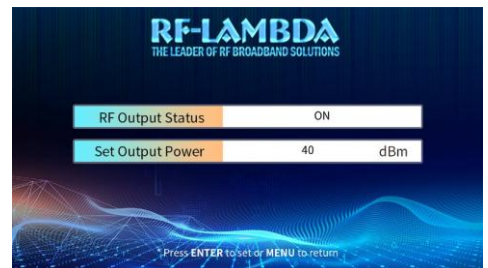
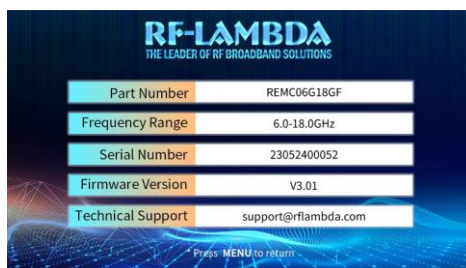
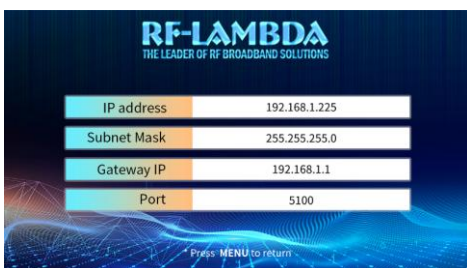
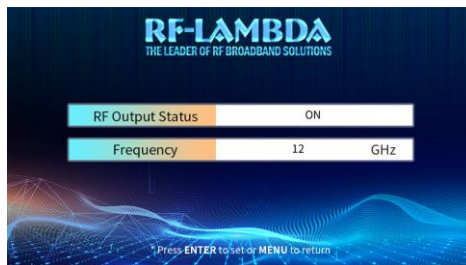

All action functions will ask for confirming execution when selected from function selection menu.

Protection Connector Table

Female D-Sub is on the housing
The mating male part number: 172-E15-203R001

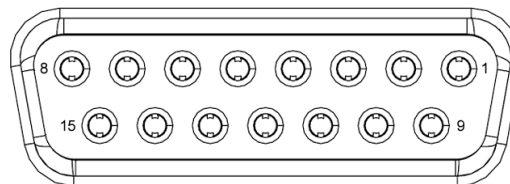

Pin #	Name	Function	Initial State	Description	Applied
1	Reset	Control		Resets PA when logic <u>LOW</u> is applied and released	Yes
2	Gate Disable	Control	LOW	Applying logic <u>HIGH</u> disables gate of amplifiers	Yes
3	Drain Disable	Control	LOW	Applying logic <u>HIGH</u> disables drain of amplifiers	Yes
4	RF IN Over	Indicator	LOW	Pin will be latched to logic <u>HIGH</u> when input signal is over limit	Yes
5	Temp Over	Indicator	LOW	Pin will be latched to logic <u>HIGH</u> when amplifier is driven over temperature	Yes
6	Current Over	Indicator	LOW	Pin will be latched to logic <u>HIGH</u> when drain current limit is reached	Yes
7	ID Imbalance	Indicator	LOW	Pin will be latched to logic <u>HIGH</u> when an imbalance in the drain current of the combining branches occurs	Yes
8	PA Off Alarm	Indicator	LOW	Pin will be latched to logic <u>HIGH</u> when any of the protection limit is reached	NO
9	Fan Alarm	Indicator	LOW	Pin will be latched to logic <u>HIGH</u> when Fan limit is reached	Yes
10	RF Switch OFF	Control	LOW	Applying logic <u>HIGH</u> turns RF switch to load path	Yes
11	VSWR	Indicator	LOW	Pin will be latched to logic <u>HIGH</u> when output reflection is over limit	Yes
12	5dB Attenuation	Control	LOW	Applying logic <u>HIGH</u> enables 5dB attenuation	NO
13	10dB Attenuation	Control	LOW	Applying logic <u>HIGH</u> enables 10dB attenuation	NO
14	+5V	Power Supply	+5V	+5V DC is available for reference 400mA current ability	Yes
15	GND	Ground	GND	Ground	Yes

Notes:

- HIGH/LOW voltages are standard TTL signals 0.0V-0.8V = LOW. 2.8V-5V = HIGH. Input current is 10uA.
- Matching connector and cable will be shipped with the product.
- Applied=Yes means the feature is included. Applied=No means the feature is not included with this model.
- 5V reference supply can source 700mA.
- Indicator output signals can source 24mA.

Outline Drawing

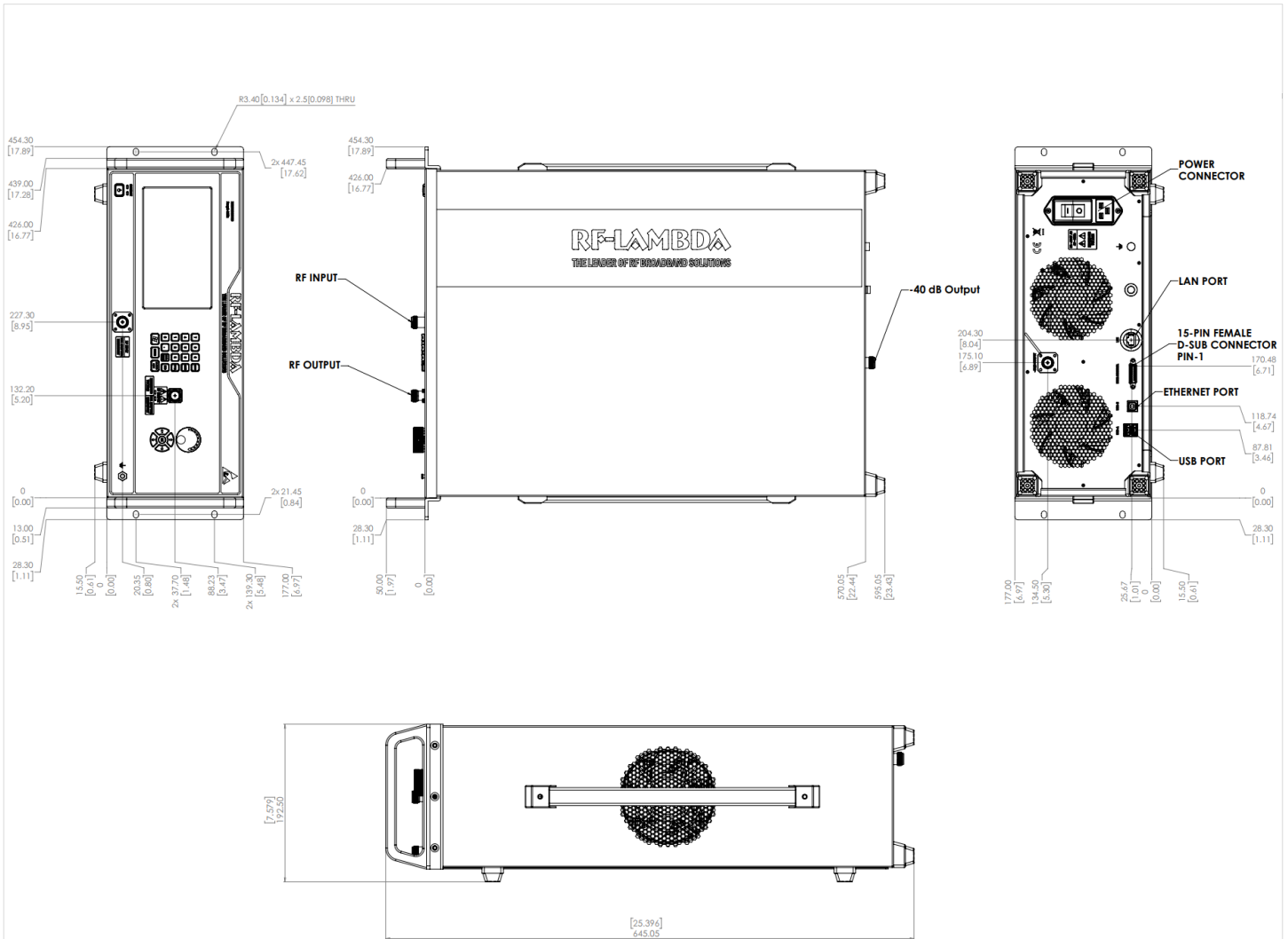

Notes:

1. All dimensions are in millimeters [inches].
2. Tolerances ± 3.0 [0.118] unless otherwise specified.



Additional Information

Documentation	Webpage
ESD Policy	https://rflambda.com/pdf/rflambda_esd_control.pdf
Heatsink Lookup Specifications	https://rflambda.com/search_heatsink.jsp
Connector Torque Specifications	https://www.rflambda.com/pdf/Torque_Specifications.pdf
Random Vibration Test Standard	https://www.rflambda.com/pdf/rflambda_random_vibration_MIL-STD-202G.pdf

Ordering Information

Part Number	Modification	Description
REMC13G16GE	Input connector SMA-Female and Output connector WR62	13GHz-15.5GHz EMC Benchtop Power Amplifier



Each amplifier is shipped in a well protected package.

Amplifier Use

Ensure that the amplifier input and output ports are safely terminated into a proper 50 ohm load before turning on the power. Never operate the amplifier without a load. A proper 50 ohm load is defined as a load with impedance less than 1.9:1 or return loss larger than 10dB relative to 50 Ohm within the specified operating band width.

Power Supply Requirements

Power supply must be able to provide adequate current for the amplifier. Power supply should be able to provide 1.5 times the typical current or 1.2 times the maximum current (whichever is greater).

In most cases, RF - Lambda amplifiers will withstand severe mismatches without damage. However, operation with poor loads is discouraged. If prolonged operation with poor or unknown loads is expected, an external device such as an isolator or circulator should be used to protect the amplifier.

Ensure that the power is off when connecting or disconnecting the input or output of the amp.

Prevent overdriving the amplifier. Do not exceed the recommended input power level.

Adequate heat-sinking required for RF amplifier modules. Please inquire.

Amplifiers do not contain Thermal protection, Reverse DC polarity or Over voltage protection with the exception of a few models. Please inquire.

Proper electrostatic discharge (ESD) precautions are recommended to avoid performance degradation or loss of functionality.

What is not covered with warranty?

Each RF - Lambda amplifier will go through power and temperature stress testing.

Since the die, ICs or MMICs are fragile, these are not covered by warranty. Any damage to these will NOT be free to repair.

Important Notice

The information contained herein is believed to be reliable. RF-Lambda makes no warranties regarding the information contained herein. RF-Lambda assumes no responsibility or liability whatsoever for any of the information contained herein. RF-Lambda assumes no responsibility or liability whatsoever for the use of the information contained herein. The information contained herein is provided "AS IS, WHERE IS" and with all faults, and the entire risk associated with such information is entirely with the user. All information contained herein is subject to change without notice. Customers should obtain and verify the latest relevant information before placing orders for RF-Lambda products. The information contained herein or any use of such information does not grant, explicitly or implicitly, to any party any patent rights, licenses, or any other intellectual property rights, whether with regard to such information itself or anything described by such information.

RF-Lambda products are not warranted or authorized for use as critical components in medical, life-saving, or life sustaining applications, or other applications where a failure would reasonably be expected to cause severe personal injury or death.