

Outdoor Ruggedized IP67 Rated Wide Band AC Power Amplifier 2GHz-6GHz



Features

- Wideband Solid State Power Amplifier
- Small Signal Gain 50dB Typical
- Output Saturation Power 44dBm Typical
- Supply Voltage 110/220 VAC
- 50 Ohm Matched Input/Output
- Drain Overvoltage Protection
- Drain Overcurrent Protection
- IP67 Rating

Product Description

RAMP02G06GA-IP67 is an outdoor rated IP67 wideband power amplifier with a frequency range of 2 to 6GHz.

The power output of this amplifier is 44dBm typical. The typical small signal gain is 50dB with a variance of ± 5 dB. This excellent performance is achieved through the use of GaN devices.

The AC power amplifier uses a standard convenient 110V/220 VAC power supply. The fan and heatsink are completely integrated inside the unit.

The power amplifier's input and output connectors are SMA.

The operating temperature of this product is within -40 to +85°C.

Typical Applications

- Wireless Infrastructure
- Military and Aerospace Applications
- Test Instrumentation
- Radar Systems
- 5G Wireless Communications
- Microwave Radio Systems
- TR Modules
- Research and Development
- Cellular Base Stations

Electrical Specifications (T_A=+25°C)

Parameter	Min	Typ	Max	Units
Frequency Range		2 – 6		GHz
Small Signal Gain		50		dB
Gain Variance		+/-5		dB
Gain Variation Over Temperature (-40°C to +70°C)		+/-3		dB
Input Return Loss		-15		dB
*Saturated Output Power (P _{sat})		44		dBm
Supply Current (V _{cc} = +28VDC)		0.7	3	A
IM3		-25		dBc
Weight		5		lbs.
Impedance		50		Ohms
Input / Output Connectors	SMA Female			
Package	Screw Sealed Painted Finish			

Note: Special screening is available with extra cost. Please inquire with sales.

Absolute Maximum Ratings

Parameter	Rating
Supply Voltage Range	230VAC
*RF Input Power (RFIN)	Psat – Large Signal Gain

Bias Up Procedure

1. Connect input and output with 50 Ohm source/load. (In band VSWR < 1.9:1 or >10dB return loss.)
2. Connect Power Cable
3. Turn On Back Panel AC Power Supply Switch
4. Press Front Panel Power Switch to Power Display

Bias Down Procedure

1. Press Front Panel Power Switch to Power Off Display
2. Turn Off Back Panel AC Power Supply Switch
3. Remove Power Cable (If Moving Equipment)
4. Disconnect input and output with 50 Ohm source/load. (In band VSWR < 1.9:1 or >10dB return loss.)

Environmental Specifications and Test Standards

Parameter	Description
Operational Temperature	-40°C to +70°C (Case Temperature)
Storage Temperature	-55°C to +125°C
Thermal Shock	-40°C → +85°C (5 Cycles / 10 hours)
**Random Vibration	MIL-STD-202G Table 214-I, Test Condition Letter C 1.5 Hours Per Axis
High Temperature Burn In	Temperature +85°C for 72 Hours
Shock	1. Weight >20g, 50g half sine wave for 11ms, Speed variation 3.44m/s 2. Weight <=20g, 100g Half sine wave for 6ms, Speed variation 3.75m/s 3. Total 18 times (6 directions, 3 repetitions per direction).
Altitude	Standard: 30,000 Ft (Epoxy Sealed Controlled Environment) Optional: Hermetically Sealed (60,000 ft. 1.0 PSI min)
Hermetically Sealed (Optional)	MIL-STD-883 (For Hermetically Sealed Units)

Notes:

- Maximum RF input power is set to assure safety of amplifier. Input power may be increased at own risk to achieve full power of amplifier. Please reference gain and power curves.
- For vibration testing details please see additional information section

Typical Performance Plots

Input Return Loss vs Frequency @+25°C

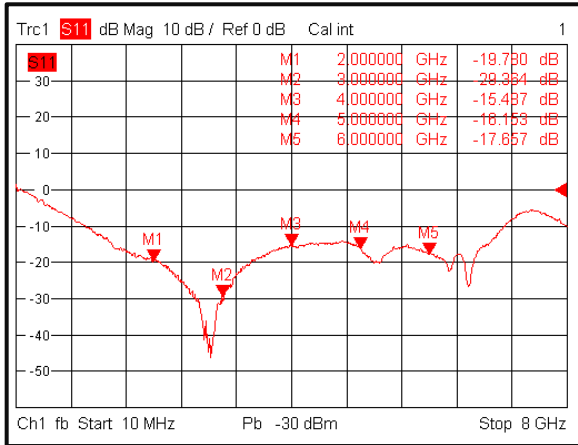

Gain vs Frequency @+25°C

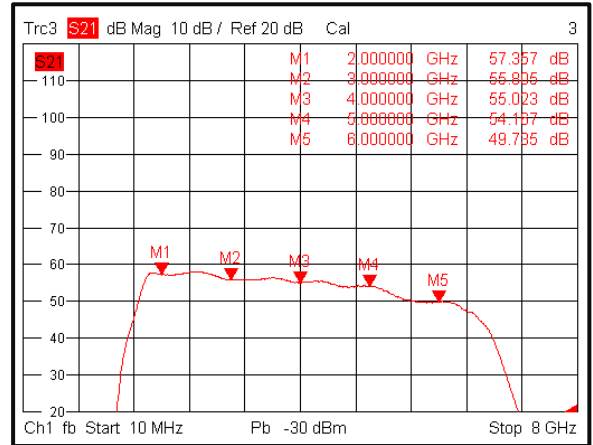

Output Return Loss vs Frequency @+25°C

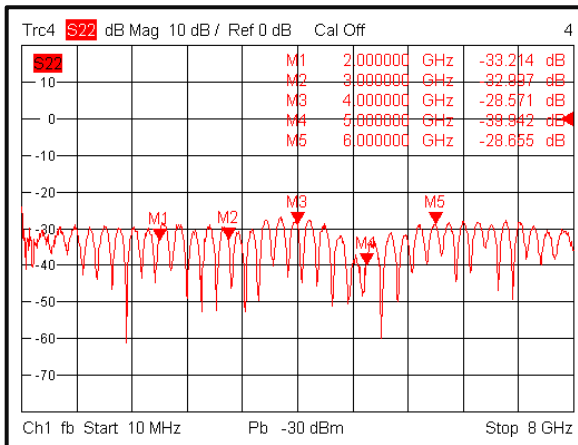

Isolation vs Frequency @+25°C

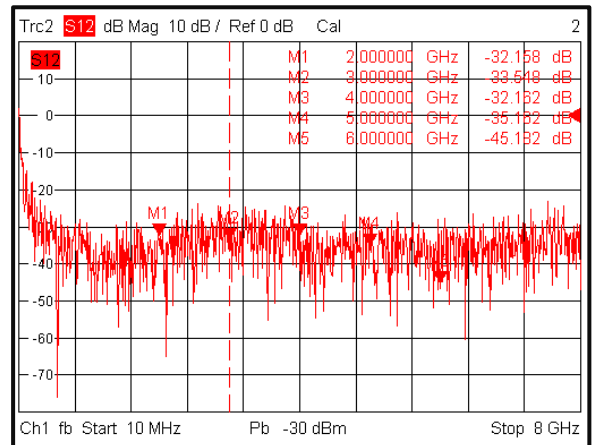

Note: Small signal VNA measurements include attenuators to protect equipment

Typical Performance Plots

Gain vs Output Power CW

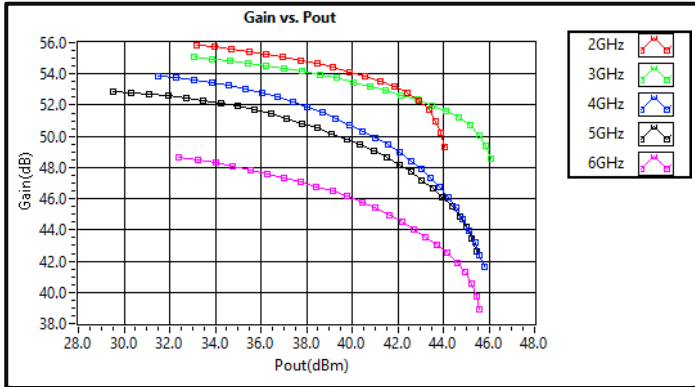

Gain vs Output Power *Pulse

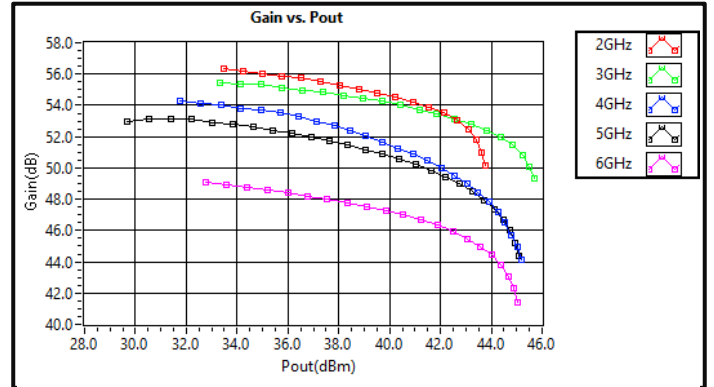

Output vs Input Power CW

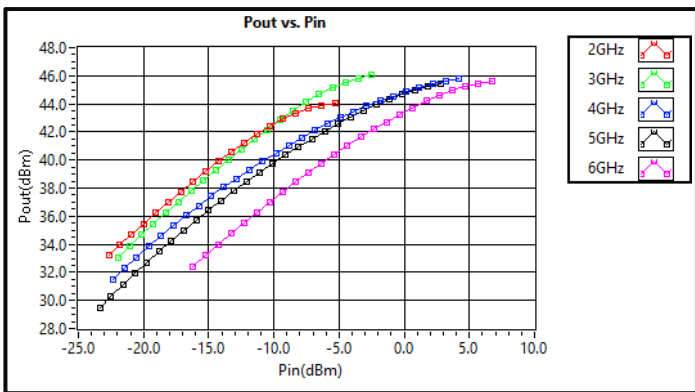

Output vs Input Power *Pulse

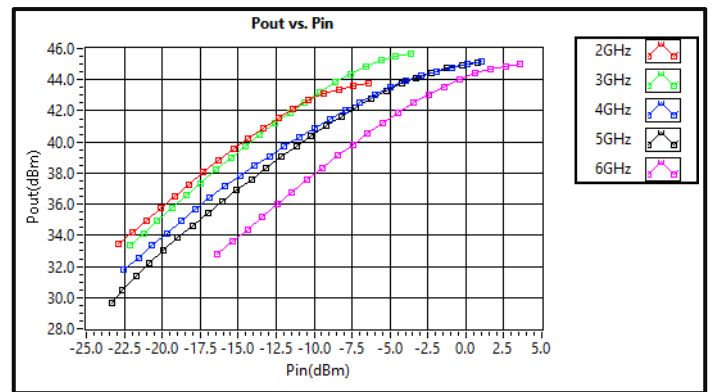

PxdB vs Frequency CW

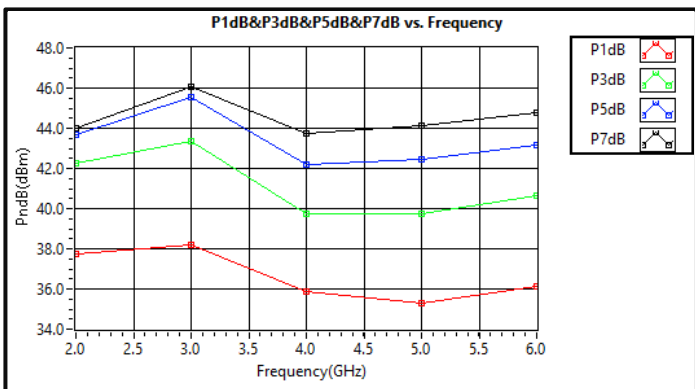

PxdB vs Frequency *Pulse

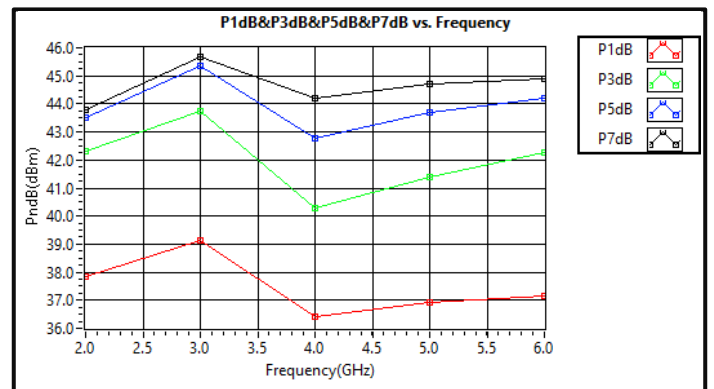

*Pulse Psat power test signal: 20μs pulse width with 10% duty cycle.

Typical Performance Plots

Left IM3 vs Output Power

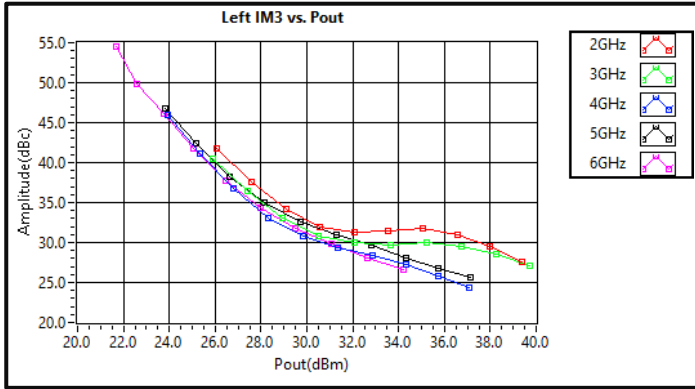

Right IM3 vs Output Power

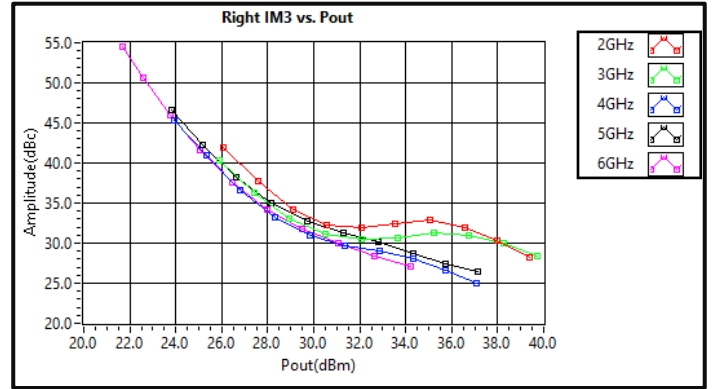

Delta IM3 vs Output Power

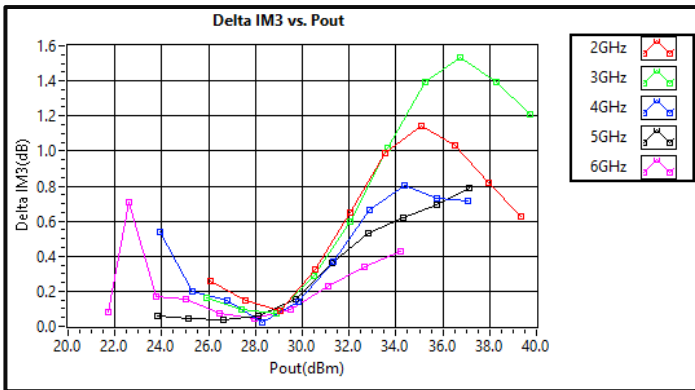

Current vs Output Power (+28VDC)

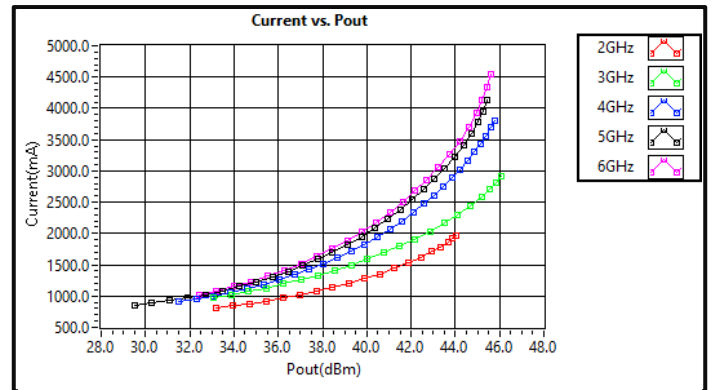

Note: IM3 test performed with 1MHz tone spacing

Alarm Status Panel

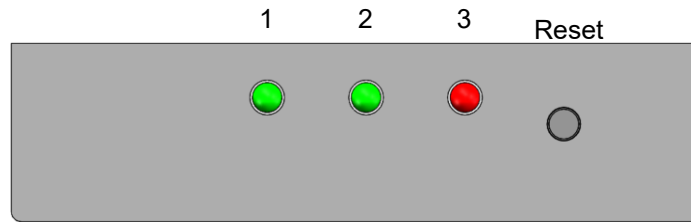

LED #	Name	Function	Initial State	Description	Applied
1	Temp	Indicator	Green	PA will shut down and latch this LED to a RED color when recommended case temperature is exceeded	Yes
2	ID	Indicator	Green	PA will shut down and latch this LED to a RED color when a drain current limit is exceeded	Yes
3	Power	Indicator	Red	LED will light to RED color when supply power is applied	Yes
	Reset*	Control		Manual reset button to reset PA	Yes

Note: LED needs to be manually reset to initial state by pressing RESET button

Protection Connector Table

Female D-Sub is on the housing
The mating male part number: 172-E15-103R001

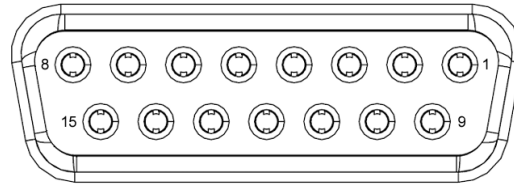

Pin #	Name	Function	Initial State	Description	Applied
1	Reset	Control	HIGH	Resets PA when logic <u>LOW</u> is applied and released	Yes
2	Drain Disable	Control	LOW	Applying logic <u>HIGH</u> disables drains of amplifiers	Yes
3	Gate Disable	Control	LOW	Applying logic <u>HIGH</u> disables gates of amplifiers	Yes
4	NC	NC	NA	NA	NA
5	Temp Over	Indicator	LOW	Pin will be latched to logic <u>HIGH</u> when amplifier is driven over temperature	Yes
6	Current Over	Indicator	LOW	Pin will be latched to logic <u>HIGH</u> when drain current limit is reached	Yes
7	NC	NC	NA	NA	NA
8	GND	Ground	NA	GND	Yes
9	VDC	VDC	NA	DC power supply pin for amplifier	NA
10	VDC	VDC	NA	DC power supply pin for amplifier	NA
11	ID Signal	Indicator	NA	Current provided to the drain of the last stage of the amplifier is represented by voltage	Yes
12	Temp Signal	Indicator	NA	PA carrier case temperature is represented by voltage	Yes
13	+5V User	Power Supply	+5V	+5V DC is supplied for reference	Yes
14	GND	Ground	GND	Ground	Yes
15	GND	Ground	GND	Ground	Yes

Notes:

- HIGH/LOW voltages are standard TTL signals 0.0V-0.8V = LOW. 2V-5V = HIGH. Input current is 10uA.
- Matching connector and cable will be shipped with the product.
- Applied=Yes means the feature is included. Applied=No means the feature is not included with this model.
- 5V reference supply can source 700mA.
- Indicator output signals can source 24mA.

Outline Drawing

All Dimensions in mm [inches]
Tolerances ± 1.5 [0.06]

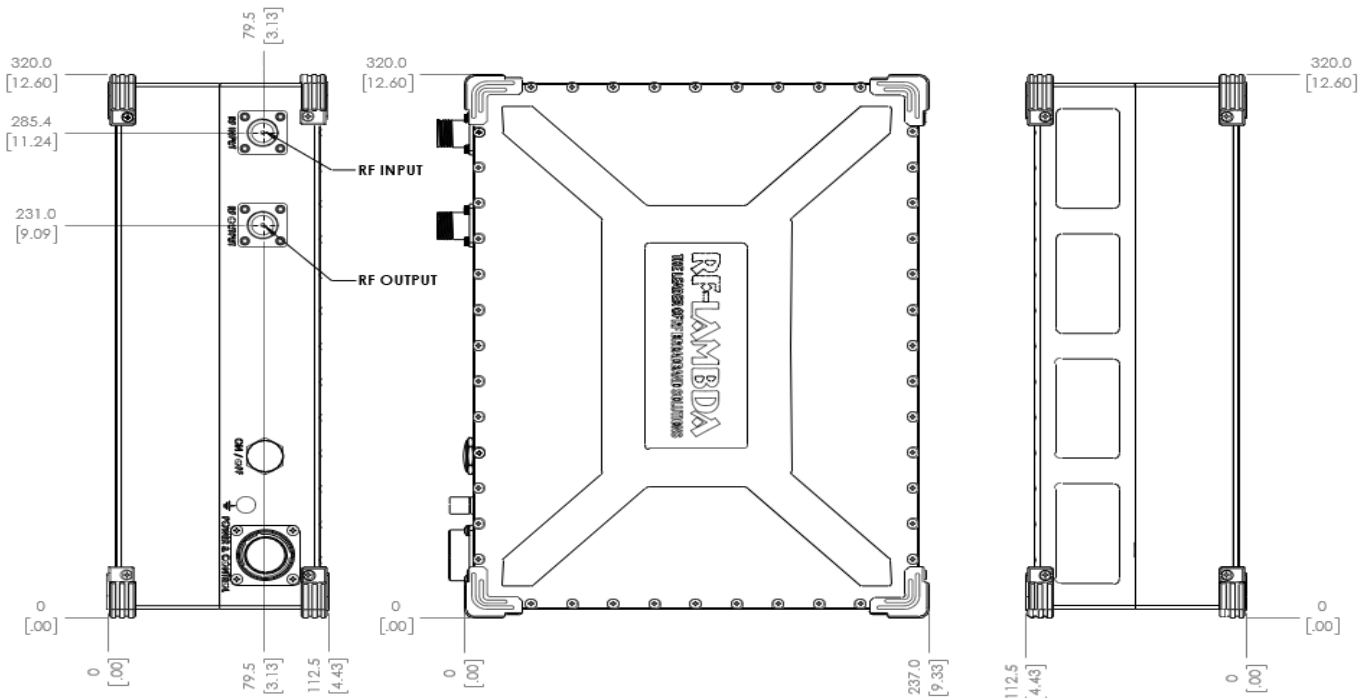

Notes:

1. All dimensions are in millimeters [inches].

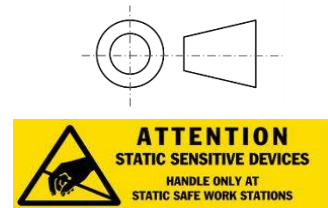

Additional Information

Documentation	Webpage
ESD Policy	https://rflambda.com/pdf/rflambda_esd_control.pdf
Heatsink Lookup Specifications	https://rflambda.com/search_heatsink.jsp
Connector Torque Specifications	https://www.rflambda.com/pdf/Torque_Specifications.pdf
Random Vibration Test Standard	https://www.rflambda.com/pdf/rflambda_random_vibration_MIL-STD-202G.pdf

Ordering Information

Part Number	Modification	Description
RAMP02G06GA-IP67	Input connector N-Type and Output connector N-Type	2GHz-6GHz AC Power Amplifier
RAMP02G06GA	Input connector SMA and Output connector SMA	2GHz-6GHz AC Power Amplifier
RFLUPA02G06GA	Input connector SMA and Output connector SMA	2GHz-6GHz DC Power Amplifier



Each AC amplifier is shipped in a well protected package.

Amplifier Use

Ensure that the amplifier input and output ports are safely terminated into a proper 50 ohm load before turning on the power. Never operate the amplifier without a load. A proper 50 ohm load is defined as a load with impedance less than 1.9:1 or return loss larger than 10dB relative to 50 Ohm within the specified operating band width.

Power Supply Requirements

Power supply must be able to provide adequate current for the amplifier. Power supply should be able to provide 1.5 times the typical current or 1.2 times the maximum current (whichever is greater).

In most cases, RF - Lambda amplifiers will withstand severe mismatches without damage. However, operation with poor loads is discouraged. If prolonged operation with poor or unknown loads is expected, an external device such as an isolator or circulator should be used to protect the amplifier.

Ensure that the power is off when connecting or disconnecting the input or output of the amp.

Prevent overdriving the amplifier. Do not exceed the recommended input power level.

Adequate heat-sinking required for RF amplifier modules. Please inquire.

Amplifiers do not contain Thermal protection, Reverse DC polarity or Over voltage protection with the exception of a few models. Please inquire.

Proper electrostatic discharge (ESD) precautions are recommended to avoid performance degradation or loss of functionality.

What is not covered with warranty?

Each RF - Lambda amplifier will go through power and temperature stress testing. Since the die, ICs or MMICs are fragile, these are not covered by warranty. Any damage to these will NOT be free to repair.

Important Notice

The information contained herein is believed to be reliable. RF-Lambda makes no warranties regarding the information contained herein. RF-Lambda assumes no responsibility or liability whatsoever for any of the information contained herein. RF-Lambda assumes no responsibility or liability whatsoever for the use of the information contained herein. The information contained herein is provided "AS IS, WHERE IS" and with all faults, and the entire risk associated with such information is entirely with the user. All information contained herein is subject to change without notice. Customers should obtain and verify the latest relevant information before placing orders for RF-Lambda products. The information contained herein or any use of such information does not grant, explicitly or implicitly, to any party any patent rights, licenses, or any other intellectual property rights, whether with regard to such information itself or anything described by such information. RF-Lambda products are not warranted or authorized for use as critical components in medical, life-saving, or life sustaining applications, or other applications where a failure would reasonably be expected to cause severe personal injury or death.