

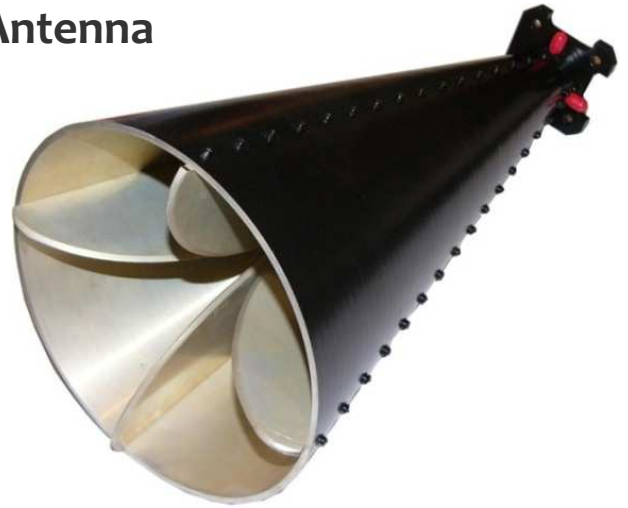

4~18GHz Coaxial Horn Quad-Ridge Antenna Double Line Polarization

Electrical and Environmental Specifications:

Frequency Range:	4.0-18.0GHz
Antenna Gain:	20dB (typ.)
Power:	100W CW
VSWR:	3.0 : 1 max.
Isolation:	20dB min
Connector:	SMA-Female
Impedance:	50 ohm
Operational Temp. :	-55°C~+85° C
Storage Temp. :	-55°C~+100° C



Summary:

- . High power operational up to 100W CW
- . compacted package in high gain cross band.
- . Wide bandwidth, flat frequency response
- . MIL-E-5400 standard
- . Customized unit is available upon request.

f (GHz)	G ₀ (dB)	ΔG(dB)	G(dB)
2.0	16.73	8.15	8.58
2.3	17.63	9.2	8.43
3.9	18.8	8.6	10.2
4.9	20.28	8.47	11.81
5.9	21.05	7.64	13.41
7.0	19.65	5.01	14.64
8.5	20.57	4.33	16.24
10.0	21.2	4.58	16.62
12.5	22.31	4.29	18.02
15.0	22.84	3.71	19.13
17.0	18.65	0.71	17.94
18.0	19	0.34	18.66

$G = G_0 - \Delta G$
 $G = 4\sim 18\text{GHz Gain of Polarization Horn}$
 $G_0 = \text{the standard gain of the polarization horn}$
 $\Delta G = P_1 - P_2$
 $P_1 = \text{the receiving power level of standard horn}$
 $P_2 = \text{the receiving power level of } 4\sim 18\text{GHz Polarization Horn}$

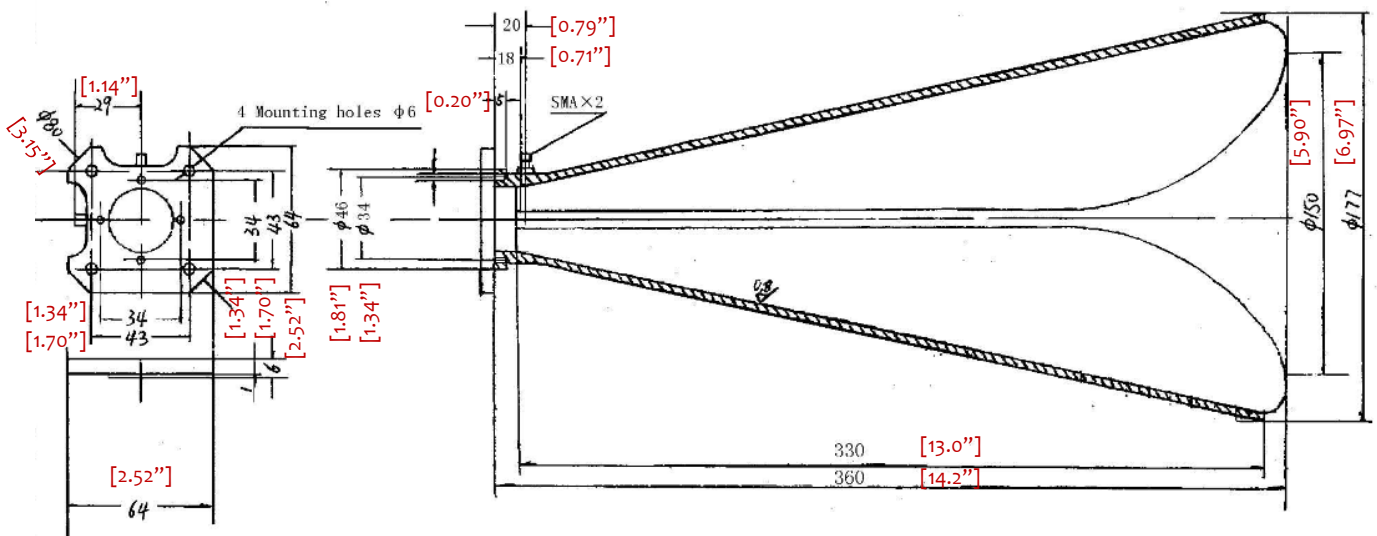

4~18GHz Coaxial Horn Antenna Quad-Ridge Double Line Polarization



RF-LAMBDA

The power beyond expectations

RCDLPHA4G18

4~18GHz Coaxial Horn Antenna Quad-Ridge Double Line Polarization

Frequency (GHz)	1st Port Reflection Ratio (db)	2nd Port Reflection Ratio (db)	Gain (dB)
1	-4.3	-1.9	7.46
2	-11.3	-16.5	8.44
3	-15.5	-11.7	10.02
4	-22.5	-15.2	12.88
5	-20.3	-15.9	12.99
6	-15.8	-13.4	13.81
7	-11.9	-16.3	13.9
8	-10.1	-20.7	15.28
9	-10.5	-12.4	17.23
10	-9.4	-7.8	15.87
11	-7.8	-9.1	21.97
12	-7.9	-6.4	22.22
13	-10.7	-7.8	23.23
14	-12.0	-9.8	23.77
15	-13.8	-23.2	24.02
16	-9.8	-21.5	24.69
17	-11.3	-17.6	22.61
18	-10.5	-4.9	20.88

Horizontal Antenna Data
Quad Ridge Horn

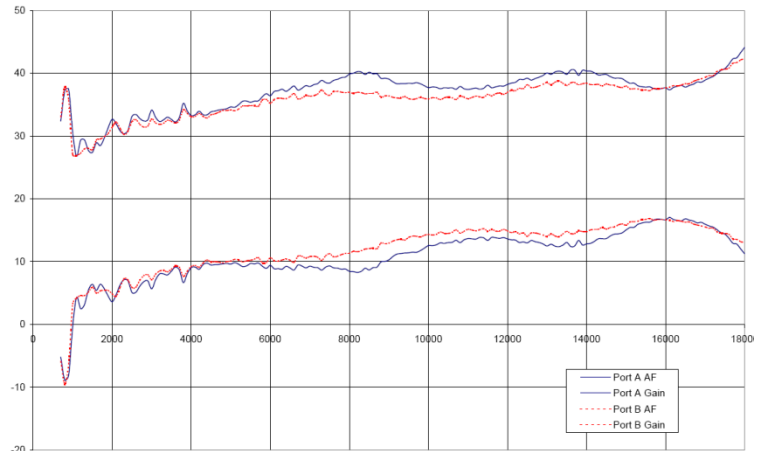

Vertical Antenna Data
Quad Ridge Horn

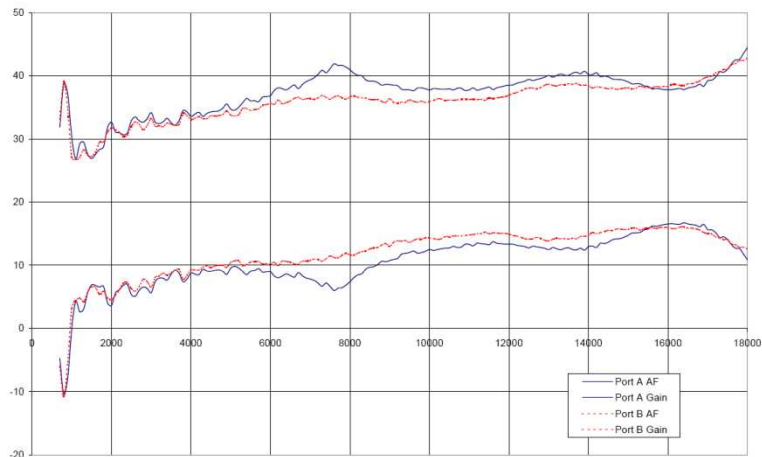

Actual Field Testing Data
(After narrow tuning for 4-18GHz)

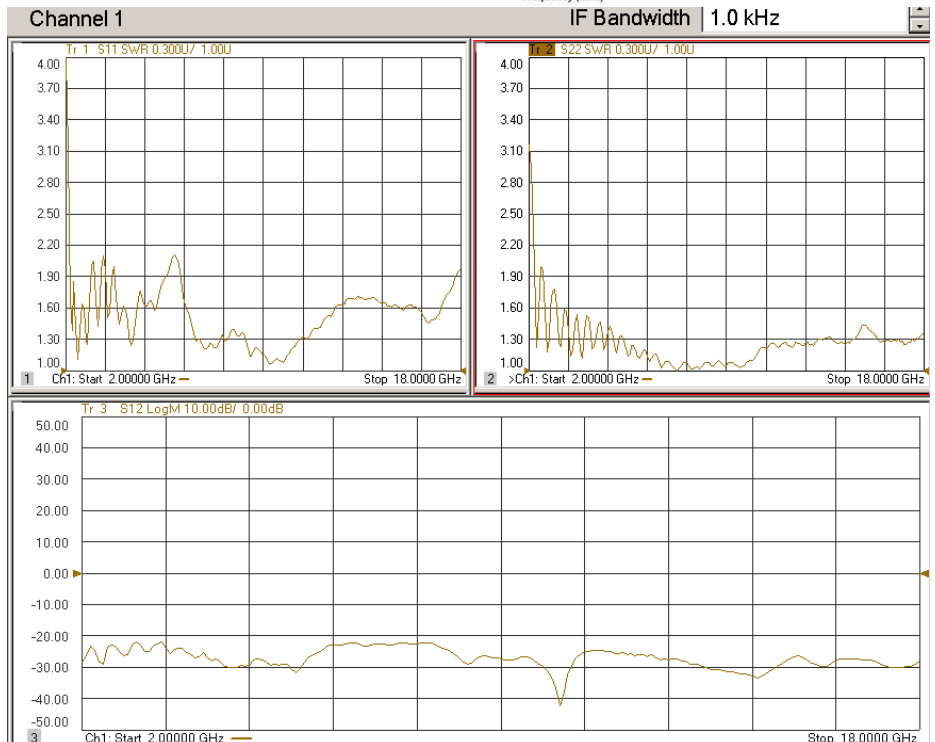

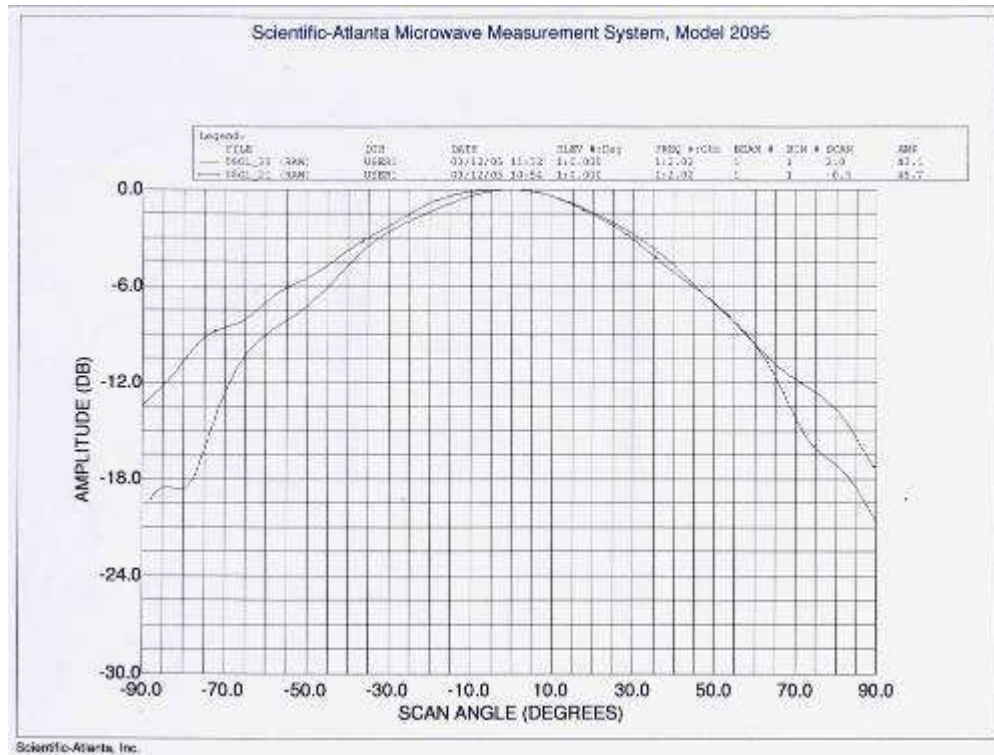

Frequency 2GHz Horizontal and Vertical Plane

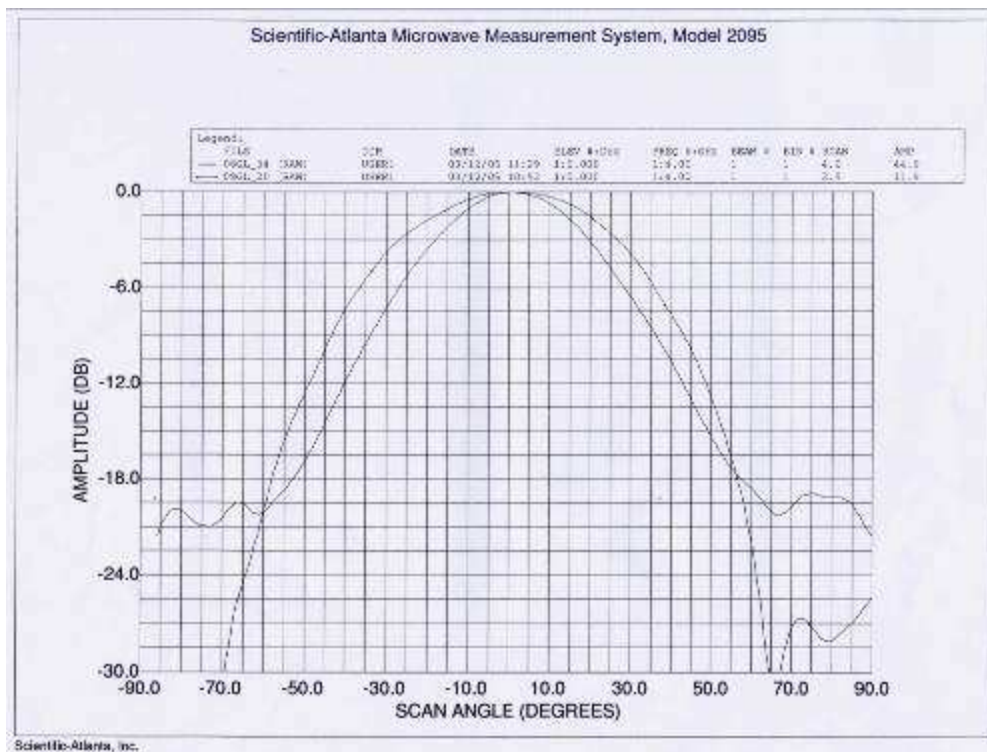

Frequency 4GHz Horizontal and Vertical Plane

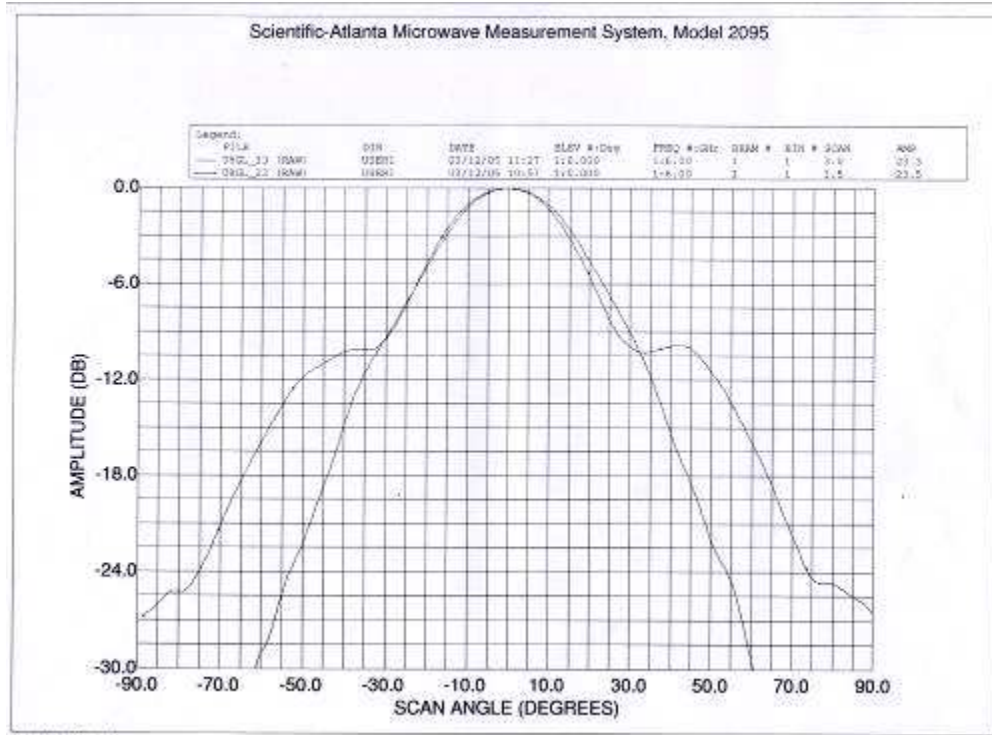

Frequency 6GHz Horizontal and Vertical Plane

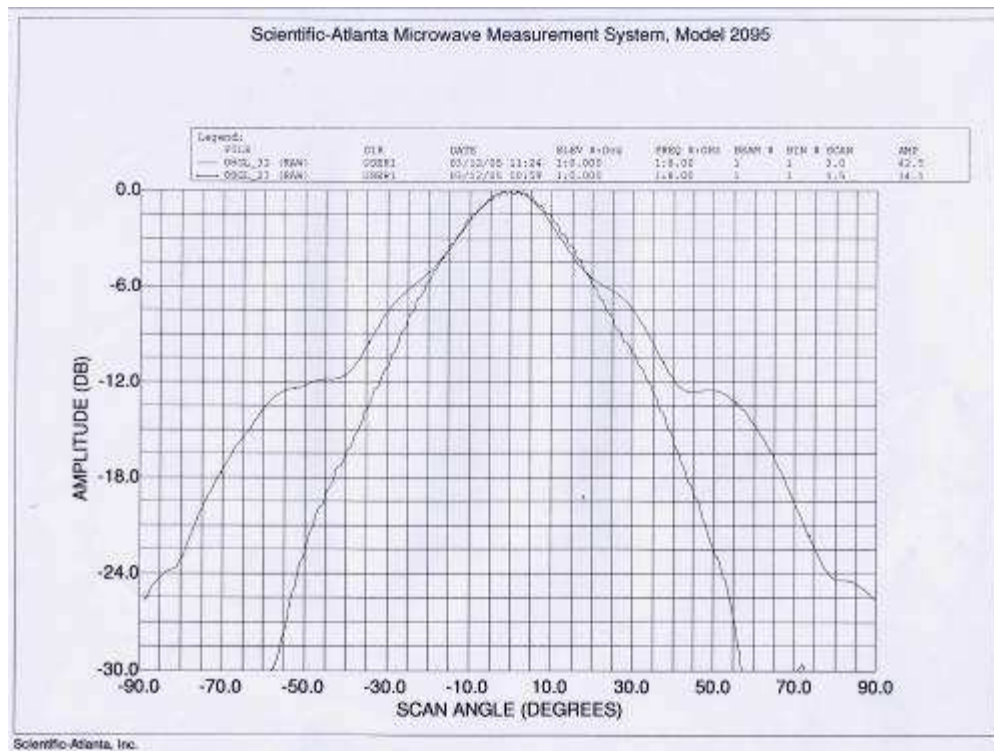

Frequency 8GHz Horizontal and Vertical Plane

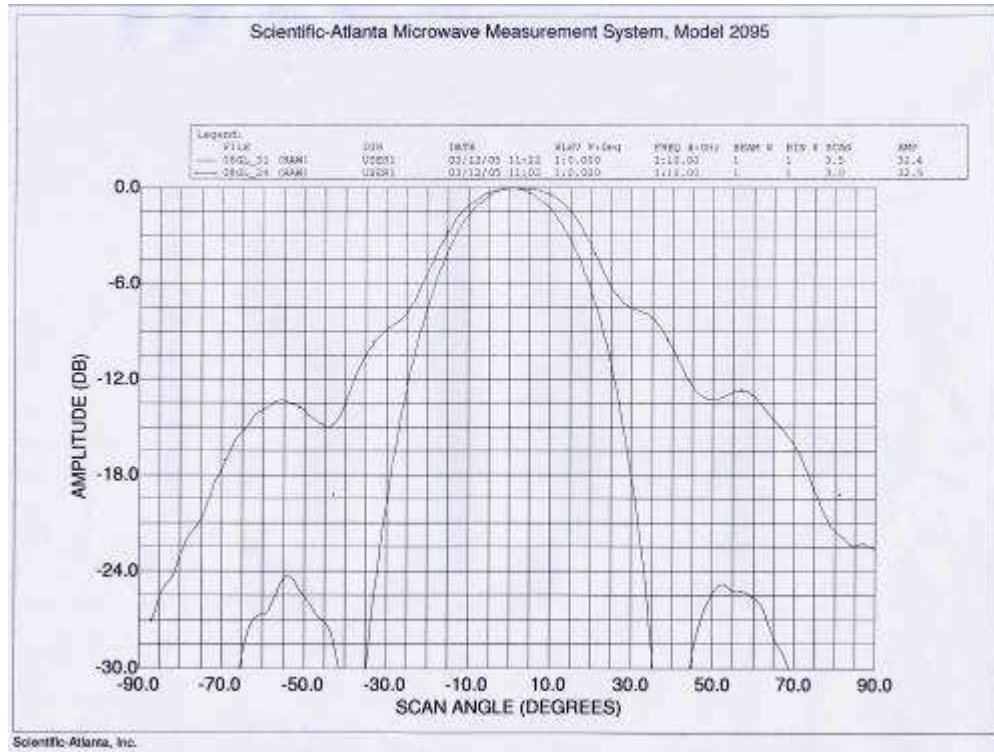

Frequency 10GHz Horizontal and Vertical Plane

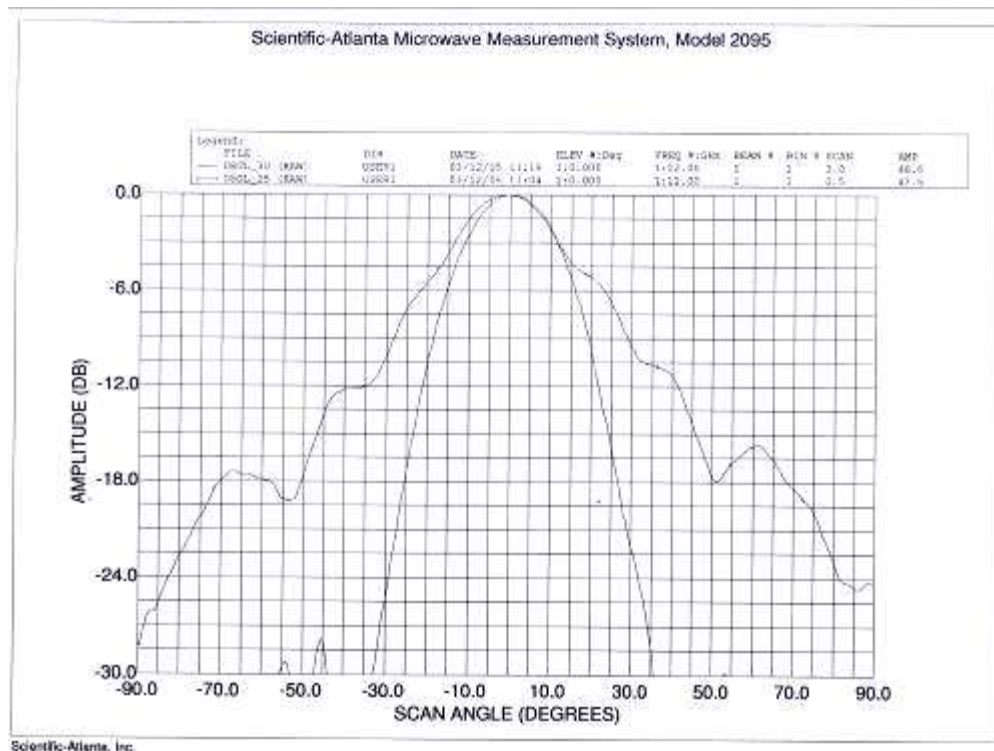

Frequency 12GHz Horizontal and Vertical Plane

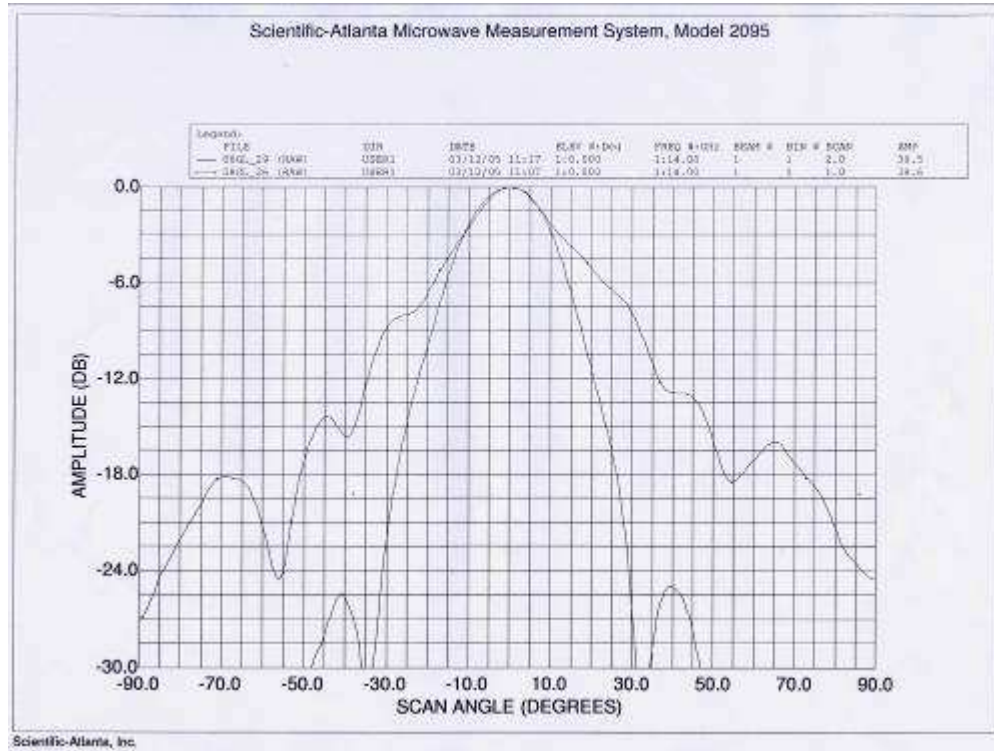

Frequency 14GHz Horizontal and Vertical Plane

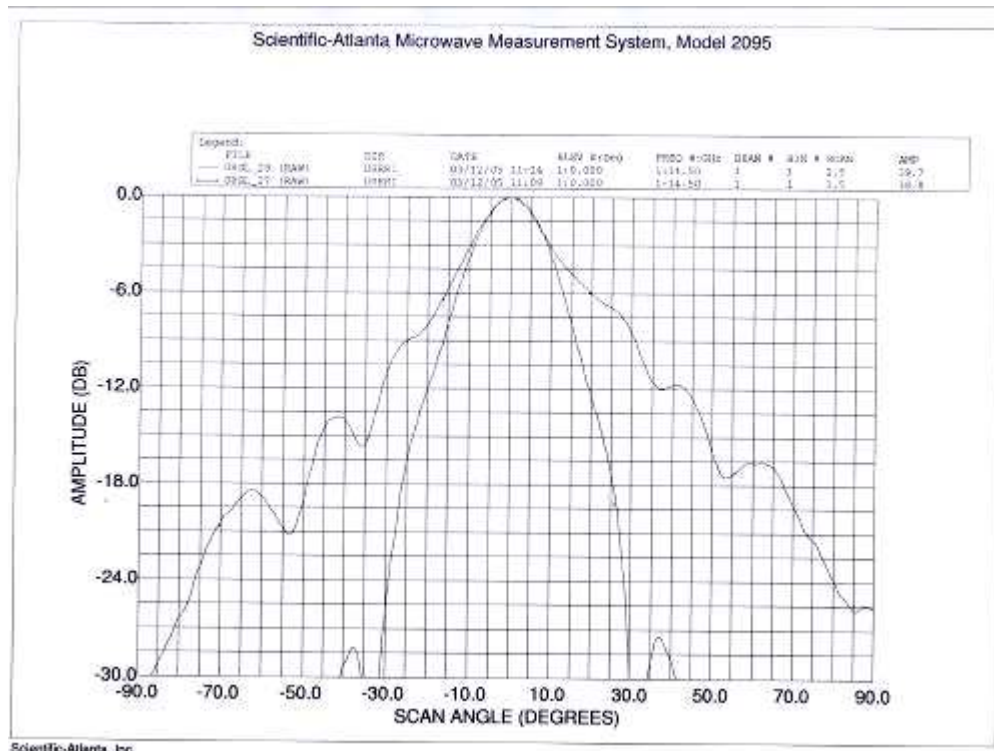

Frequency 14.5GHz Horizontal and Vertical Plane



RF-LAMBDA

The power beyond expectations

RCDLPHA4G18

4~18GHz Coaxial Horn Antenna Quad-Ridge Double Line Polarization

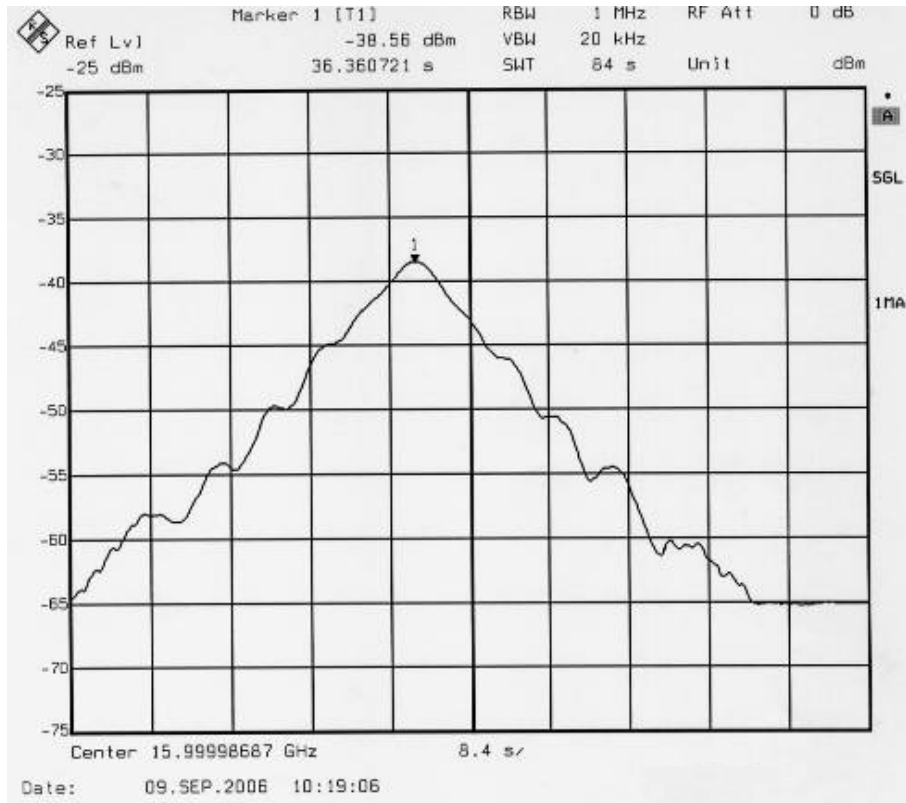

Frequency 16GHz Horizontal Plane

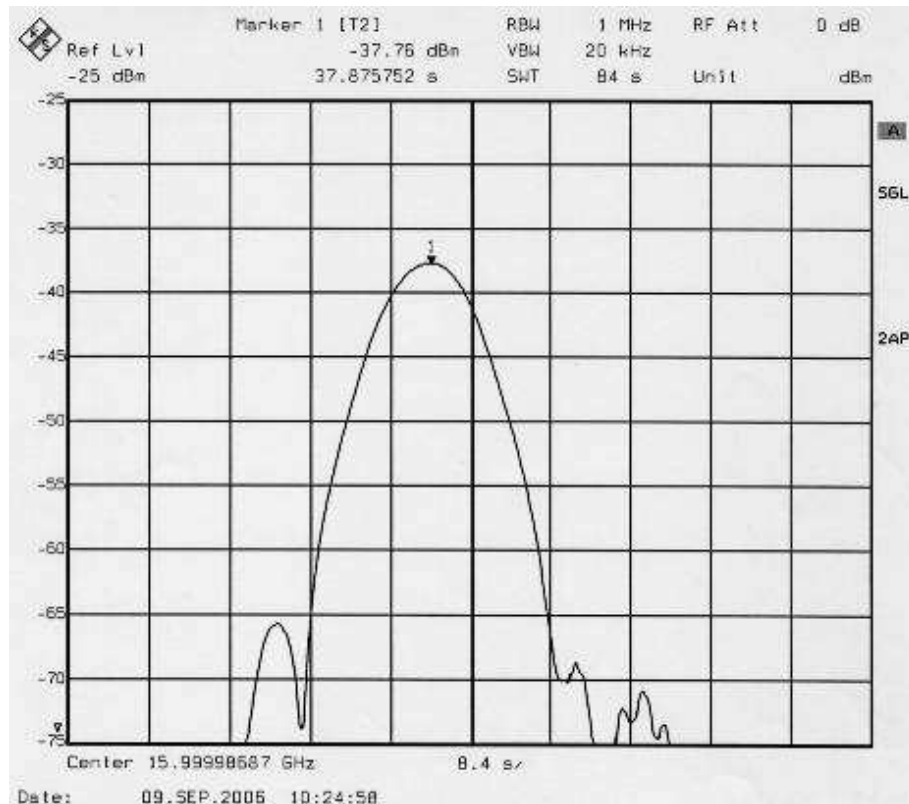

Frequency 16GHz Vertical Plane

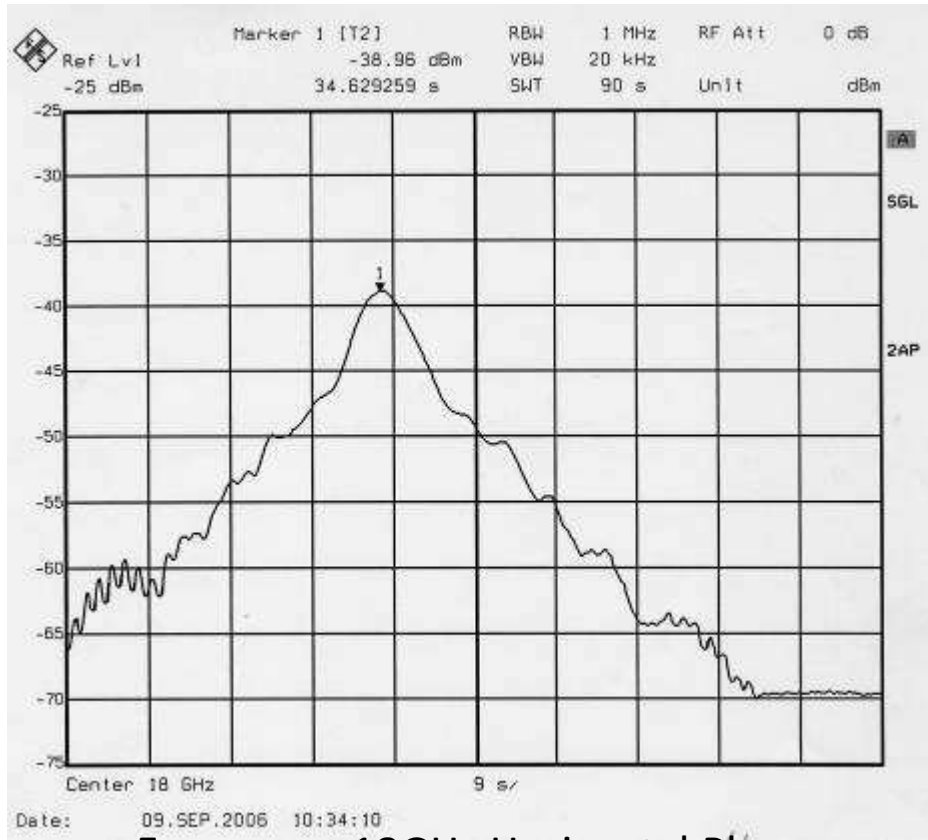

Frequency 18GHz Horizontal Plane

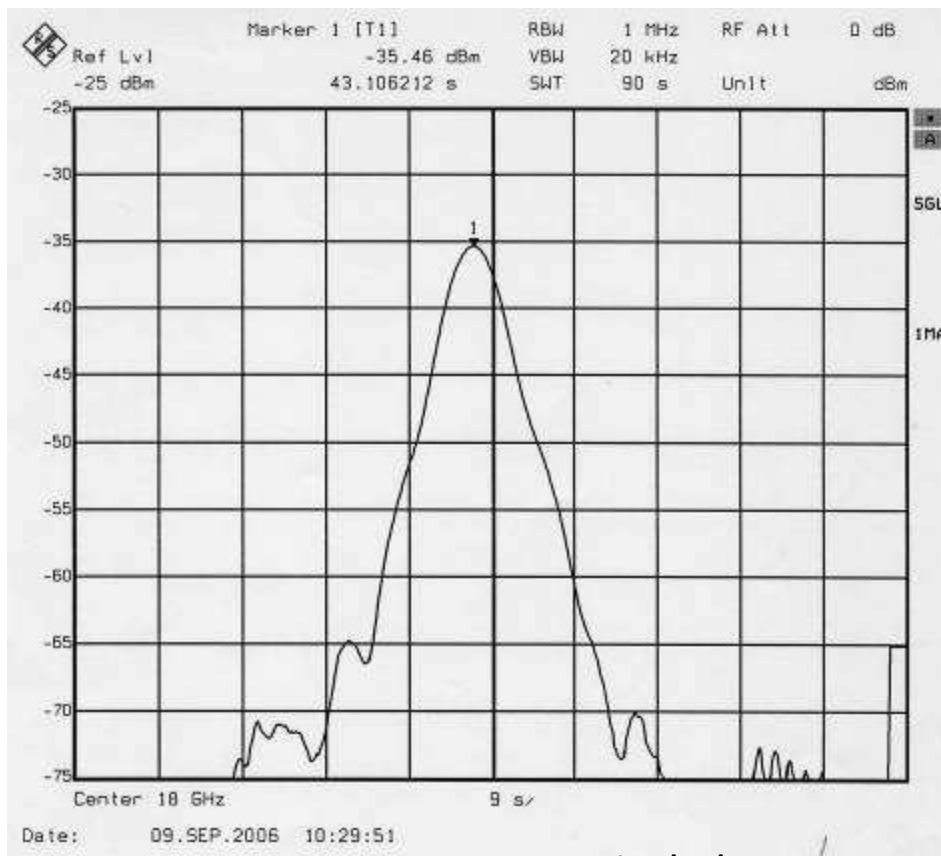

Frequency 18GHz Vertical Plane



RF-LAMBDA

The power beyond expectations

RCDLPHA4G18

4~18GHz Coaxial Horn Antenna Quad-Ridge Double Line Polarization

