

Reflective Coaxial SP2T Switch 0.01GHz-6GHz

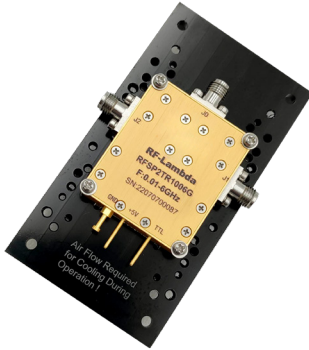

Product Description

RFSP2TR1006G is a reflective coaxial single pole double throw switch with a frequency range of 0.01 to 6GHz.

The maximum power input of this switch is 46dBm. The insertion loss is 0.8dB with a typical isolation of 28dB.

The product features of fast switching speed, low insertion loss and high isolation.

The working temperature of this product is between - 40°C and + 85°C

Features

- TTL compatible driver included
- Fast Switching Speed
- High Power Cold Switching
- Insertion Loss 0.8dB Typical
- Isolation 28dB Typical
- 50 Ohm Matched

Typical Applications

- Wireless Infrastructure
- Military and Aerospace Applications
- Test Instrumentation
- Radar Systems
- 5G Wireless Communications
- Microwave Radio Systems
- TR Modules
- Research and Development
- Cellular Base Stations

Electrical Specifications(TA = +25°C), Vdd = +5V, TTL = 0 / +5V

| Parameter | Min | Typ | Max | Min | Typ | Max | Units |
|--|--------------------------------|--------|--|-----|-----------|-----|--------|
| Frequency Range | | 0.01-3 | | | 3-6 | | GHz |
| Insertion Loss | | 0.8 | 1.0 | | 1.1 | 1.3 | dB |
| Insertion Loss Temperature Coefficient | | 0.003 | | | 0.003 | | dB/ °C |
| Isolation | 31 | 37 | | 23 | 28 | | dB |
| Input VSWR | | 1.3 | 1.4 | | 1.3 | 1.5 | : 1 |
| Output VSWR | | 1.3 | 1.4 | | 1.3 | 1.5 | : 1 |
| RF Input Power | | | 46 | | | 46 | dBm |
| DC Power Dissipation | | 0.7 | | | 0.7 | | W |
| 0.1dB Compression Point(P0.1dB) | | 46 | | | 46 | | dBm |
| IIP3 | | 55 | | | 55 | | dBm |
| Switching Speed | | 100 | 200 | | 100 | 200 | ns |
| Bias Current (+5V) | | | 100 | | | | mA |
| Weight | Net | | | | 0.2 Max | | lbs |
| | Including Heat sink | | | | 0.38 Max. | | |
| Impedance | | | 50 | | | | Ω |
| Input / Output Connectors | | | SMA-Female(Input) – SMA-Female(Output) | | | | |
| Package | Epoxy Sealed (Standard) | | | | | | |
| | Hermetically Sealed (Optional) | | | | | | |

Absolute Maximum Ratings

| Parameter | Rating |
|-----------|---------|
| Biasing | +5V±10% |

Notes:

1. If the device operates in high power state, recommend keeping case temperature lower than 60°C.
2. Cold Switching: Before changing any TTL signal(s), the RF input power must be blanked or the switch could be damaged.

Environmental Specifications and Test Standards

| Parameter | Description |
|--------------------------------|---|
| Operational Temperature | -40°C to +85°C (Case Temperature) |
| Storage Temperature | -50°C to +105°C |
| Thermal Shock | -40°C → +85°C (5 Cycles / 10 hours) |
| **Random Vibration | MIL-STD-202G Table 214-I, Test Condition Letter C 1.5 Hours Per Axis |
| High Temperature Burn In | Temperature +85°C for 72 Hours |
| Shock | 1. Weight >20g, 50g half sine wave for 11ms, Speed variation 3.44m/s 2. Weight <=20g, 100g Half sine wave for 6ms, Speed variation 3.75m/s 3. Total 18 times (6 directions, 3 repetitions per direction). |
| Altitude | Standard: 30,000 Ft (Epoxy Sealed Controlled Environment) Optional: Hermetically Sealed (60,000 ft. 1.0 PSI min) |
| Hermetically Sealed (Optional) | MIL-STD-883 (For Hermetically Sealed Units) |

** For vibration testing details please see additional information section.

Typical Performance Plots

Insertion Loss @+25°C

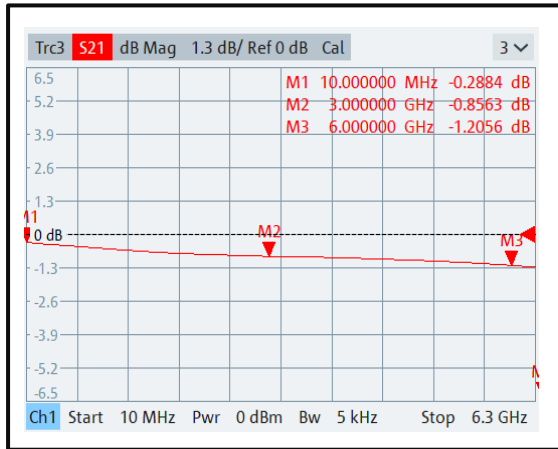

Input VSWR @+25°C

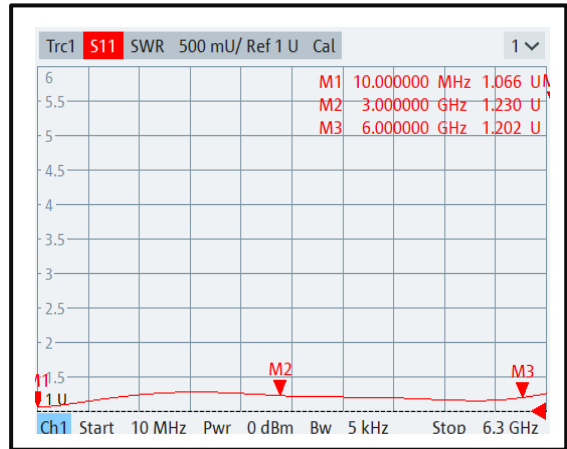

Output VSWR @+25°C

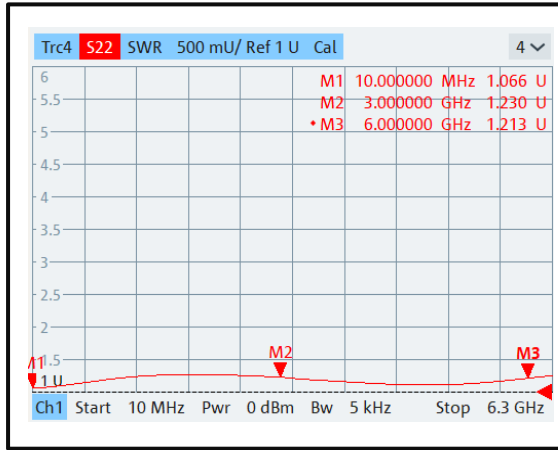

Isolation @+25°C

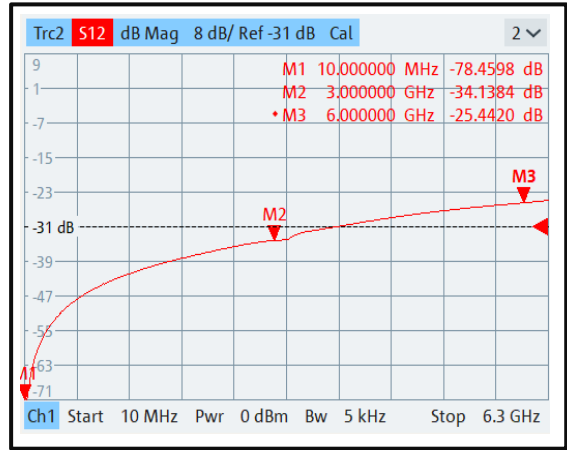

Insertion Loss @-40°C

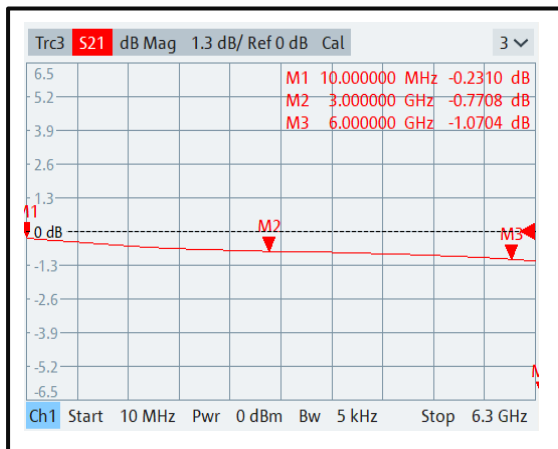

Input VSWR @-40°C

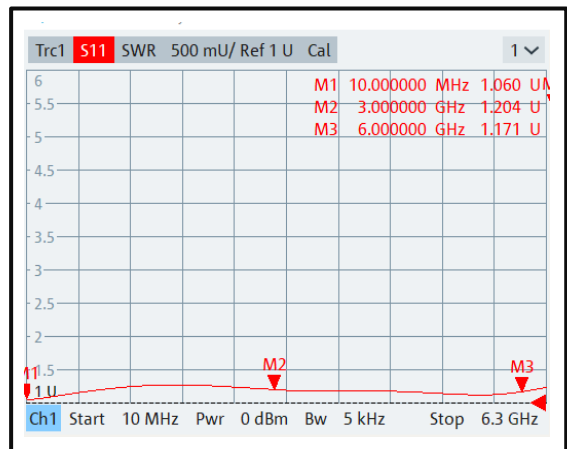

Typical Performance Plots

Output VSWR @-40°C

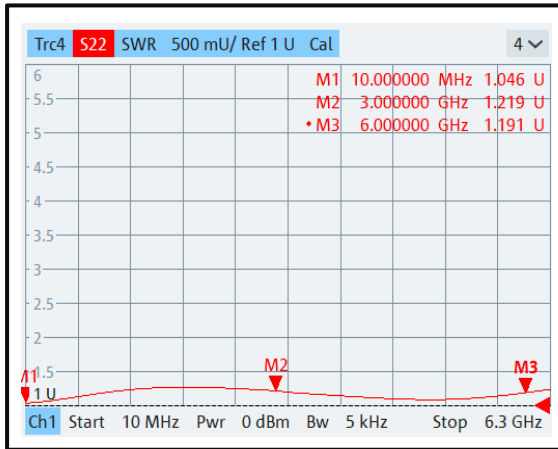

Isolation @-40°C

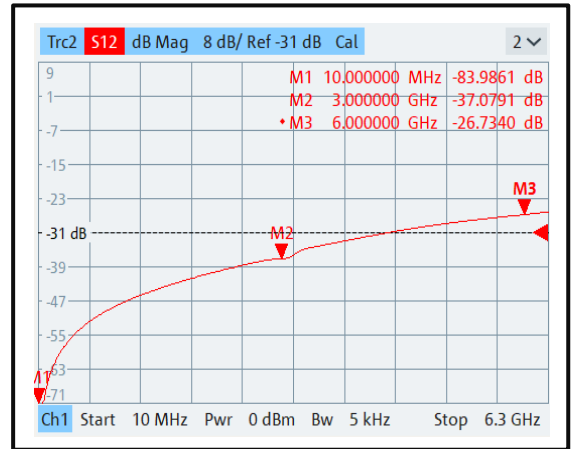

Insertion Loss @+85°C

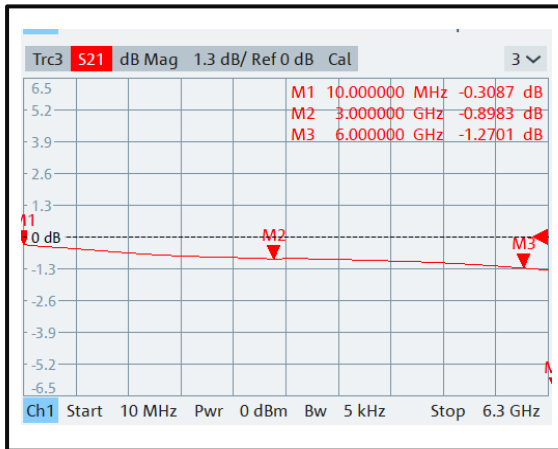

Input VSWR @+85°C

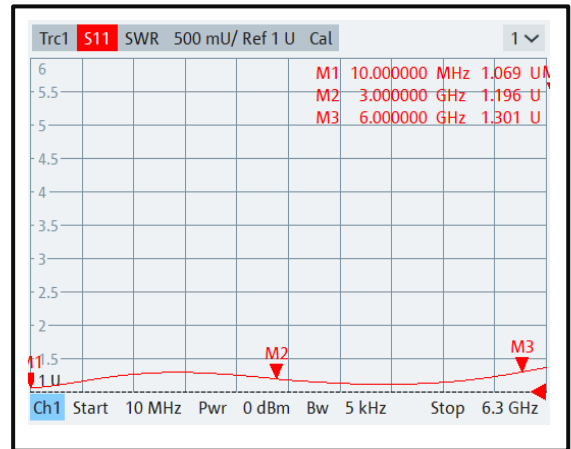

Output VSWR @+85°C

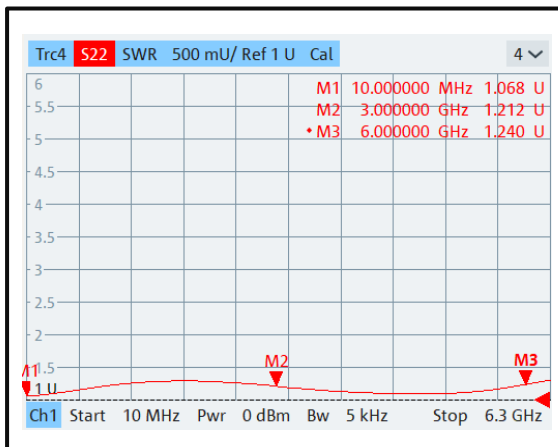

Isolation @+85°C

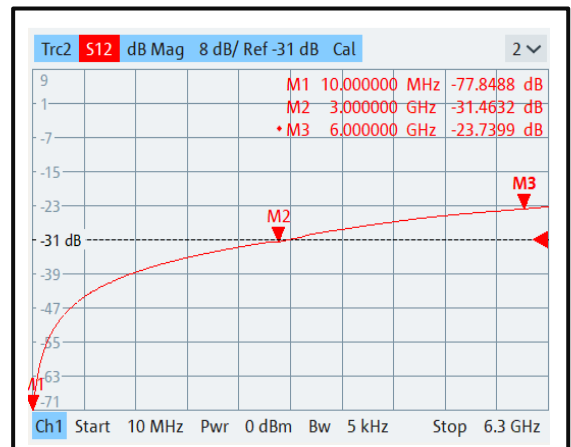

Typical Performance Plots

Insertion Loss Temperature Coefficient

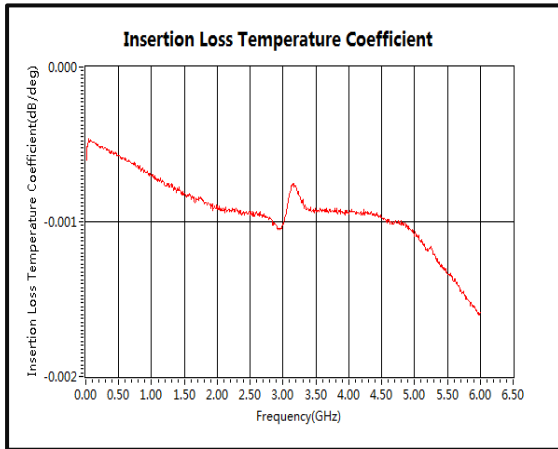

Insertion Loss vs. Temperature

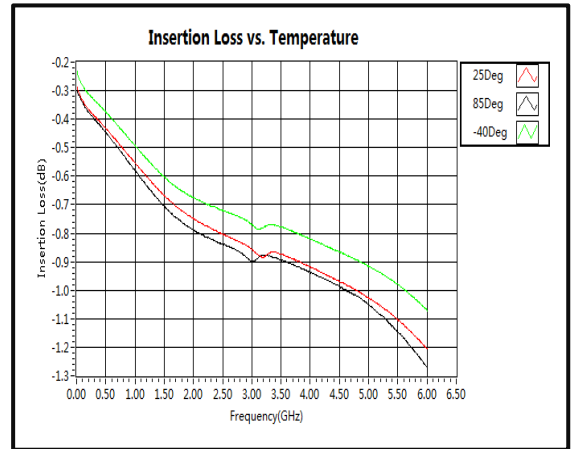

IIP3

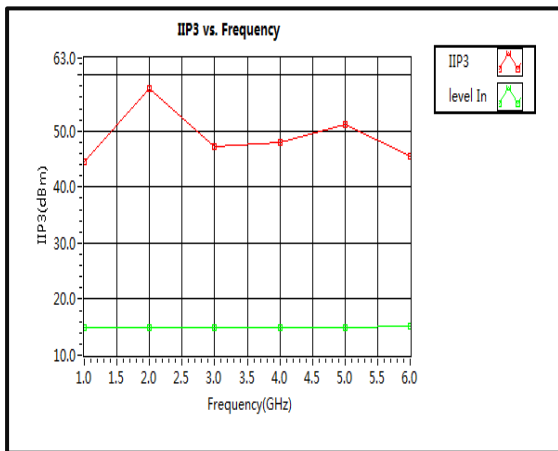

Input Power vs. Frequency

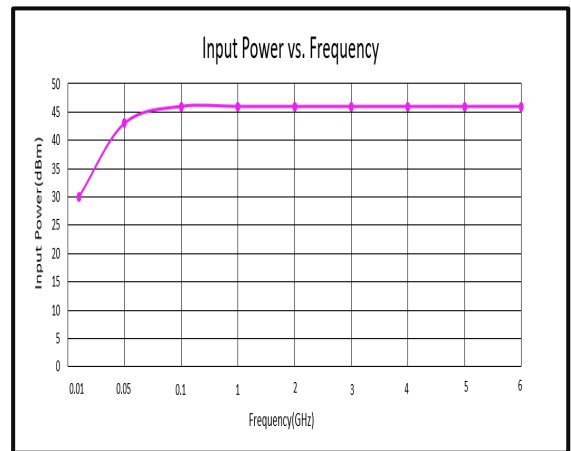

Switching Speed

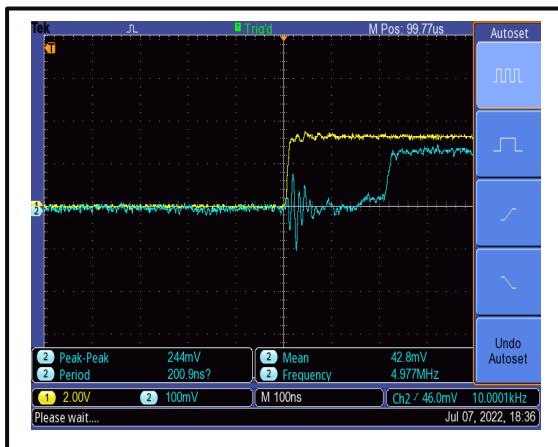

Switching Speed

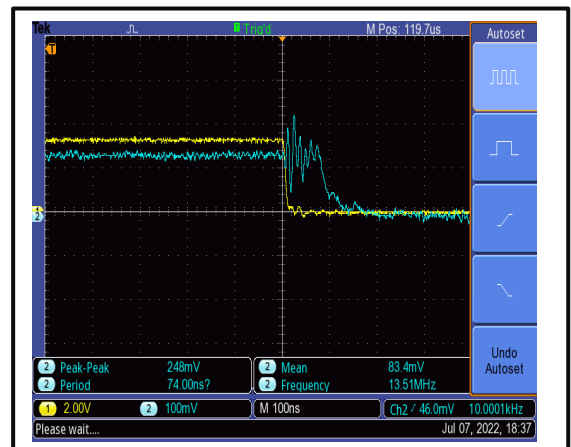

Outline Drawing

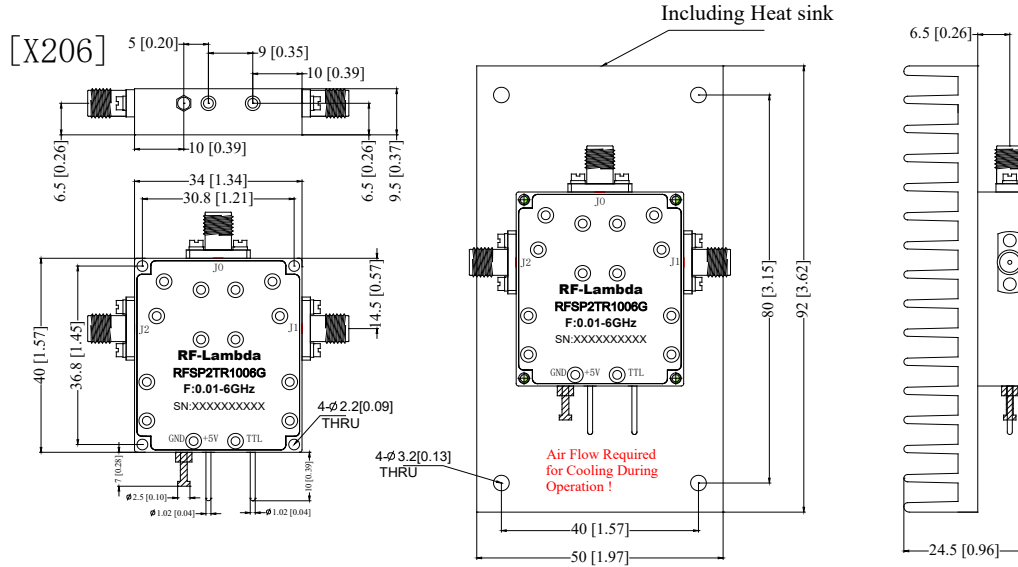

| Truth Table | |
|---------------------|--------------------------------------|
| TTL Control Voltage | Low(0)=0~0.8V |
| THRESHOLD | High(1)=2.8~5V |
| Control Input TTL | State |
| 1 | J0-J1 |
| 0 | J0-J2 |
| Control Pin | Customization available upon request |

Notes:

1. Package Material: Copper
2. Finish: Gold Plated
3. All dimensions are in millimeters [inches].
4. Housing Tolerances ± 0.1 [0.004] unless otherwise specified.
5. Heatsink Required - Mandatory for High Power Operation .Matching heatsink is listed on our website. If customer would like to use their own cooling method, please make sure the amplifier will operate under the specs that listed in page 2 of this datasheet.
6. Standard torque wrench must be used to secure RF connectors.

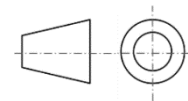

Additional Information

| Documentation | Webpage |
|---------------------------------|---|
| ESD Policy | https://rflambda.com/pdf/rflambda_esd_control.pdf |
| Heatsink Lookup Specifications | https://rflambda.com/search_heatsink.jsp |
| Connector Torque Specifications | https://www.rflambda.com/pdf/Torque_Specifications.pdf |
| Random Vibration Test Standard | https://www.rflambda.com/pdf/rflambda_random_vibration_MIL-STD-202G.pdf |

Ordering Information

| Part Number | Modification | Description |
|--------------|-----------------------|--|
| RFSP2TR1006G | Connectors SMA-Female | 0.01-6GHz Reflective Coaxial SP2T Switch |

Important Notice

The information contained herein is believed to be reliable. RF-Lambda makes no warranties regarding the information contained herein. RF-Lambda assumes no responsibility or liability whatsoever for any of the information contained herein. RF-Lambda assumes no responsibility or liability whatsoever for the use of the information contained herein. The information contained herein is provided "AS IS, WHERE IS" and with all faults, and the entire risk associated with such information is entirely with the user. All information contained herein is subject to change without notice. Customers should obtain and verify the latest relevant information before placing orders for RF-Lambda products. The information contained herein or any use of such information does not grant, explicitly or implicitly, to any party any patent rights, licenses, or any other intellectual property rights, whether with regard to such information itself or anything described by such information.

RF-Lambda products are not warranted or authorized for use as critical components in medical, life-saving, or life sustaining applications, or other applications where a failure would reasonably be expected to cause severe personal injury or death.