

## Absorptive Coaxial SP2T Switch 2GHz-4GHz



### Product Description

RFSP2TA0204G5W is an absorptive coaxial single pole double throw switch with a frequency range of 2 to 4GHz.

The maximum power input of this switch is 37dBm. The insertion loss is 1.1dB with a typical isolation of 85dB.

The product features of fast switching speed, low insertion loss and high isolation.

The working temperature of this product is between - 40°C and + 85°C

### Features

- TTL compatible driver included
- Fast Switching Speed
- High Power Cold Switching
- Insertion Loss 1.1dB
- Isolation 85dB Typical
- 50 Ohm Matched

### Typical Applications

- Wireless Infrastructure
- Military and Aerospace Applications
- Test Instrumentation
- Radar Systems
- 5G Wireless Communications
- Microwave Radio Systems
- TR Modules
- Research and Development
- Cellular Base Stations

### Electrical Specifications(TA = +25°C), Vdd = +5V, TTL = 0 / +5V

Parameter	Min	Typ	Max	Units
Frequency Range	2		4	GHz
Insertion Loss		1.1	1.3	dB
Insertion Loss Temperature Coefficient		0.003		dB/ °C
Isolation	70	85		dB
Input VSWR		1.3	1.5	: 1
Output VSWR		1.3	1.5	: 1
RF Input Power (CW)			37	dBm
DC Power Dissipation		1		W
0.1dB Compression Point (P0.1dB)		37		dBm
IIP3		55		dBm
Switching Speed		300	500	ns
Bias Current (+5V)		200		mA
Weight		0.25 Max.		lbs
Impedance		50		Ω
Input / Output Connectors	SMA-Female(Input) – SMA-Female(Output)			
Package	Epoxy Sealed (Standard)			
	Hermetically Sealed (Optional)			

**Absolute Maximum Ratings**

Parameter	Rating
Biasing	+5V±10%

- TTL pins cannot be connected to the negative voltage otherwise the internal driver will be damaged.
- Cold Switching: Before changing any TTL signal(s), the RF input power must be blanked or the switch could be damaged.

**Environmental Specifications and Test Standards**

Parameter	Description
Operational Temperature	-40°C to +85°C (Case Temperature)
Storage Temperature	-50°C to +105°C
Thermal Shock	-40°C → +85°C (5 Cycles / 10 hours)
**Random Vibration	MIL-STD-202G Table 214-I, Test Condition Letter C 1.5 Hours Per Axis
High Temperature Burn In	Temperature +85°C for 72 Hours
Shock	1. Weight >20g, 50g half sine wave for 11ms, Speed variation 3.44m/s 2. Weight <=20g, 100g Half sine wave for 6ms, Speed variation 3.75m/s 3. Total 18 times (6 directions, 3 repetitions per direction).
Altitude	Standard: 30,000 Ft (Epoxy Sealed Controlled Environment) Optional: Hermetically Sealed (60,000 ft. 1.0 PSI min)
Hermetically Sealed (Optional)	MIL-STD-883 (For Hermetically Sealed Units)

\*\* For vibration testing details please see additional information section.

Typical Performance Plots

Insertion Loss @+25°C

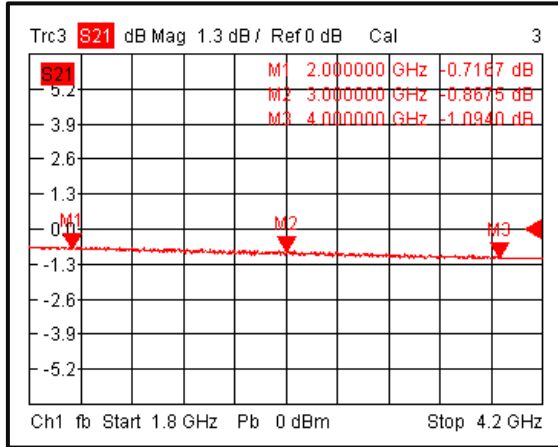

Input VSWR @+25°C

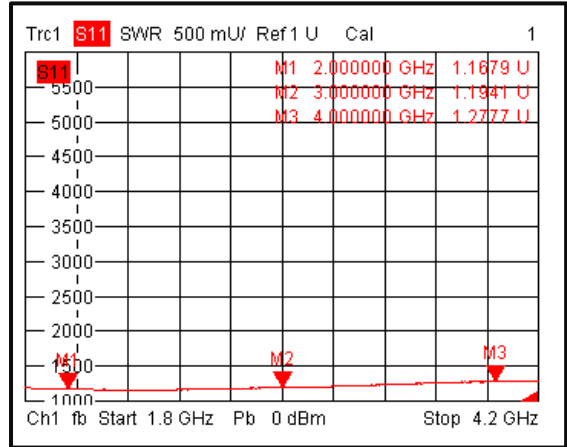

Output VSWR @+25°C

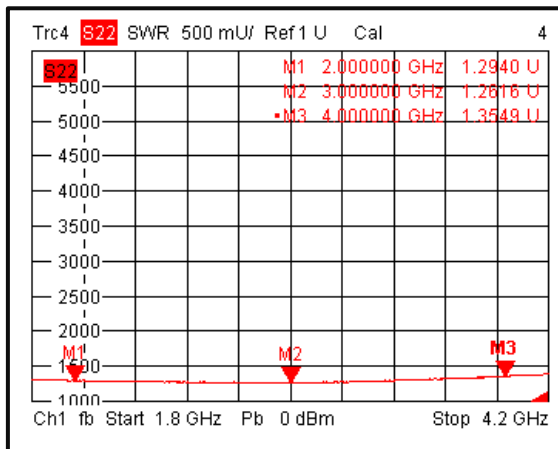

Isolation @+25°C

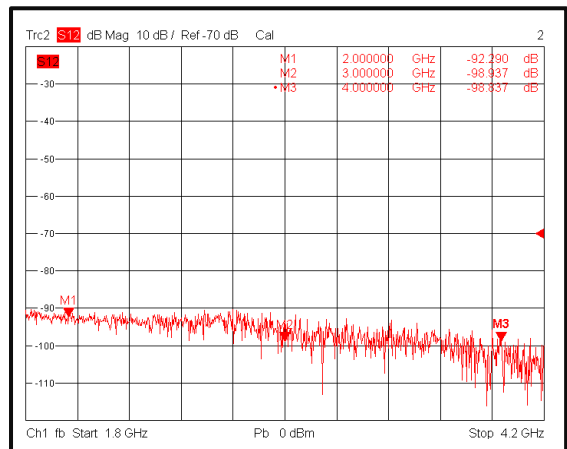

Insertion Loss @-40°C

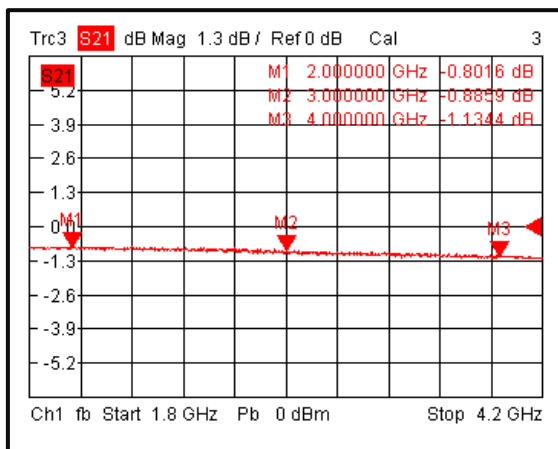

Input VSWR @-40°C

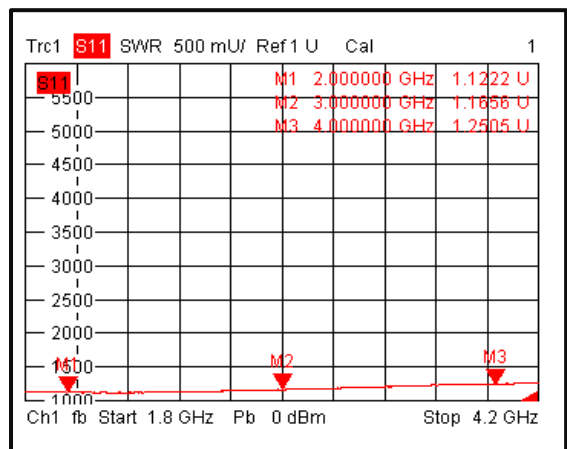

**Typical Performance Plots**

**Output VSWR @-40°C**

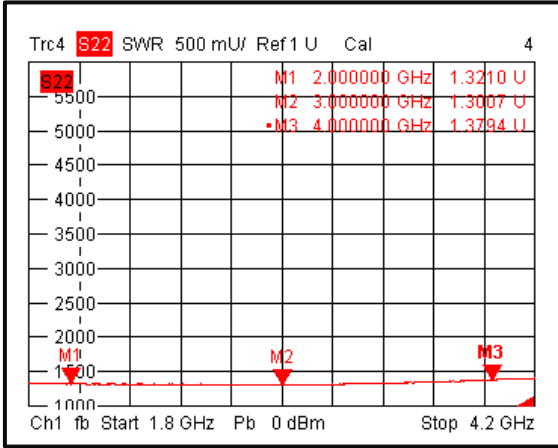

**Isolation @-40°C**

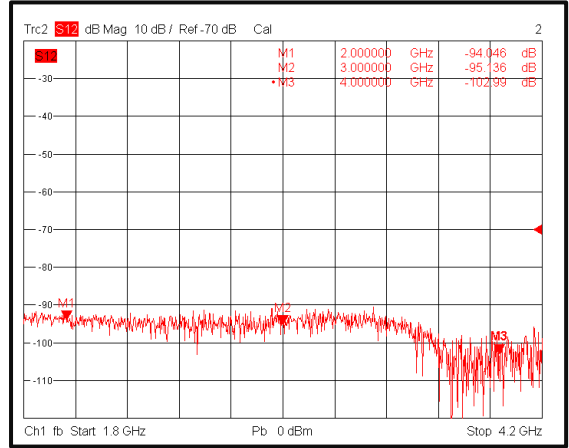

**Insertion Loss @+85°C**

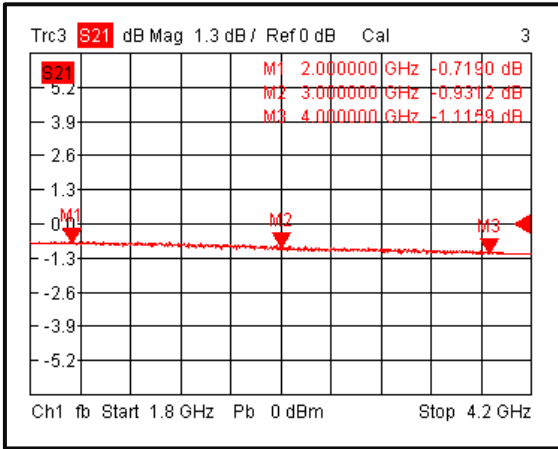

**Input VSWR @+85°C**

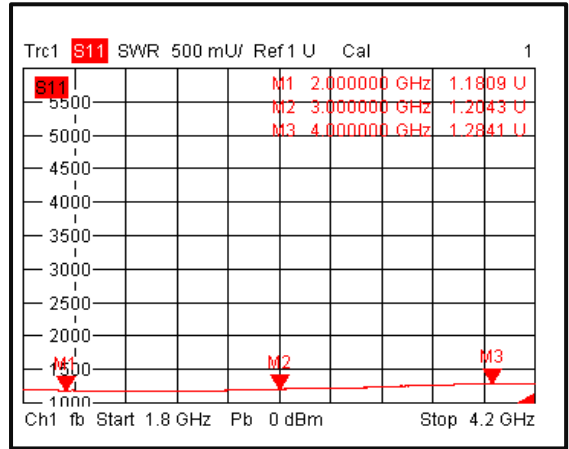

**Output VSWR @+85°C**

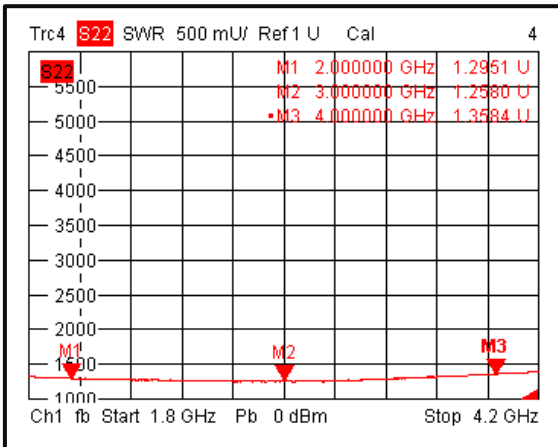

**Isolation @+85°C**

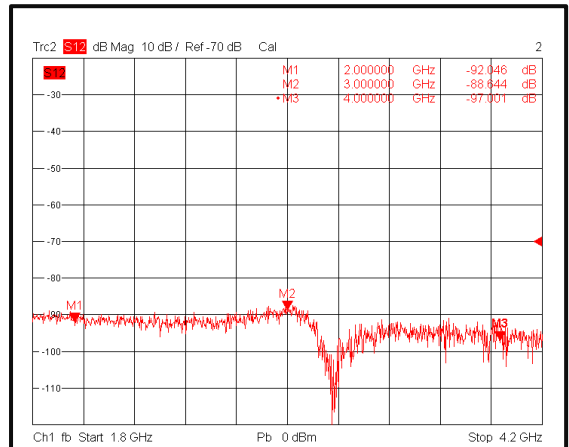

Typical Performance Plots

Insertion Loss Temperature Coefficient

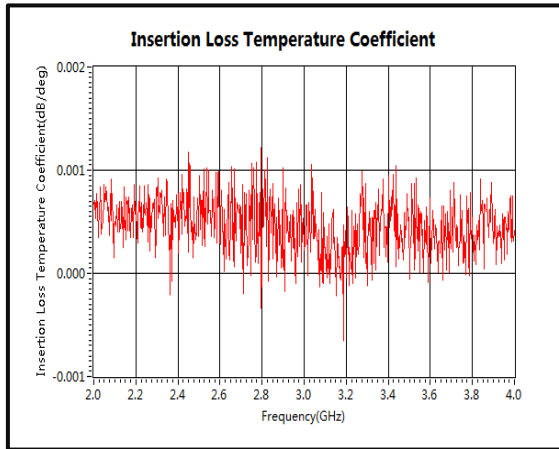

Insertion Loss vs. Temperature

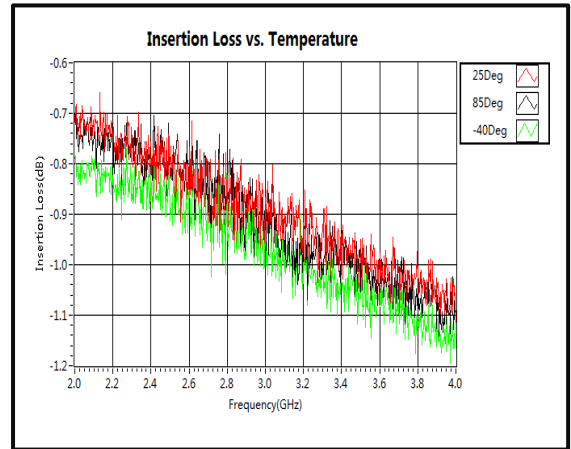

IIP3

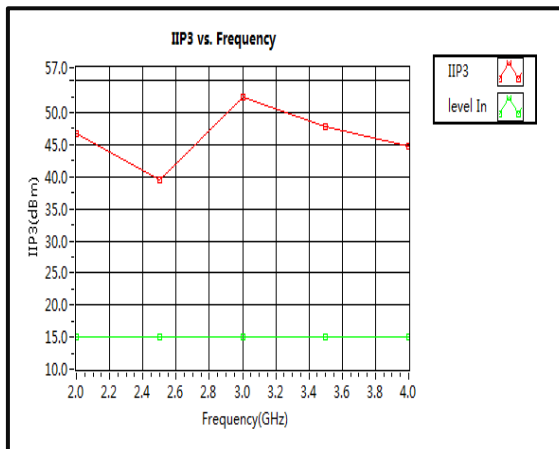

Switching Speed

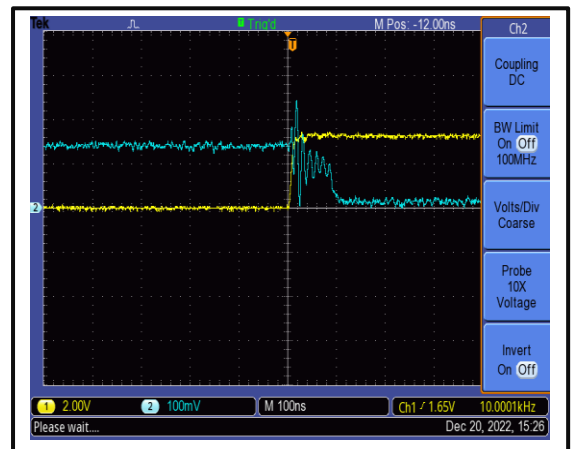

Switching Speed

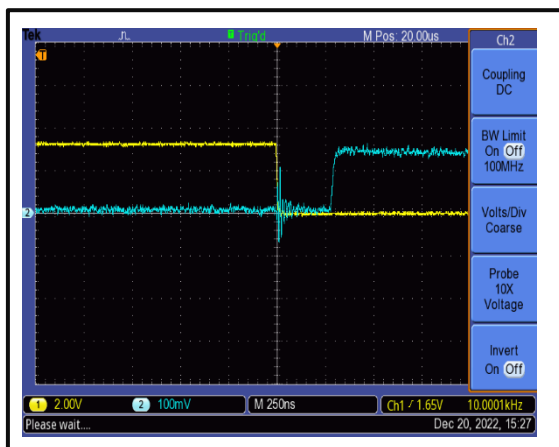

**Outline Drawing**

[X205]

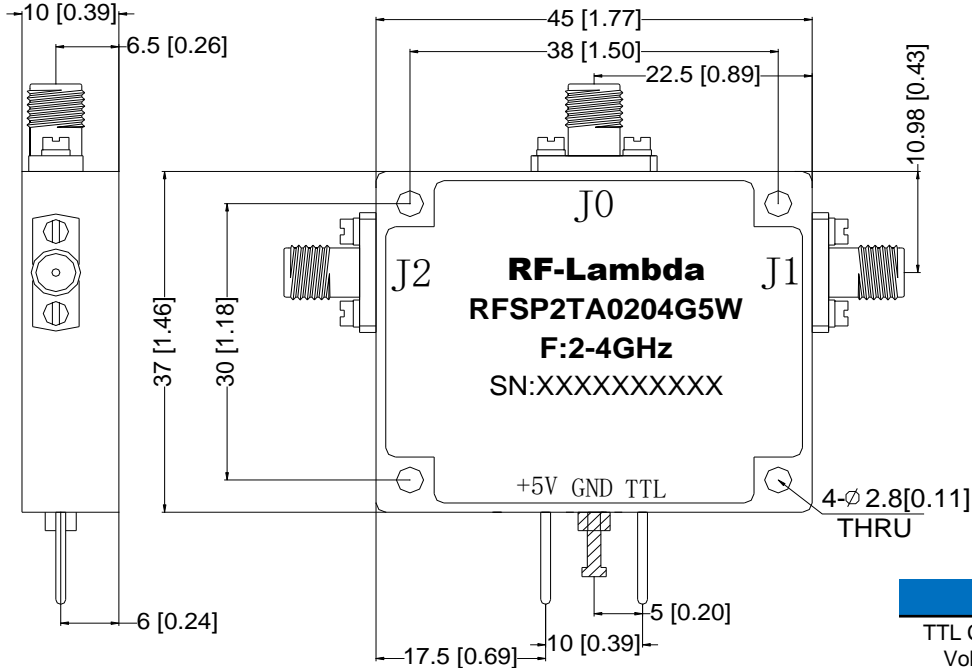

Truth Table	
TTL Control Voltage	Low(0)=0~0.8V
THRESHOLD	High(1)=2.8~5V
Control Input TTL	State
0	J0-J1
1	J0-J2
Control Pin	Customization available upon request

Notes:

1. Package Material: Aluminum
2. Finish: Gold Plated
3. All dimensions are in millimeters [inches].
4. Housing Tolerances  $\pm 0.1$  [0.004] unless otherwise specified.
5. Standard torque wrench must be used to secure RF connectors.

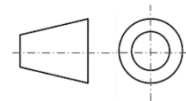

Additional Information

Documentation	Webpage
ESD Policy	<a href="https://rflambda.com/pdf/rflambda_esd_control.pdf">https://rflambda.com/pdf/rflambda_esd_control.pdf</a>
Connector Torque Specifications	<a href="https://www.rflambda.com/pdf/Torque_Specifications.pdf">https://www.rflambda.com/pdf/Torque_Specifications.pdf</a>
Random Vibration Test Standard	<a href="https://www.rflambda.com/pdf/rflambda_random_vibration_MIL-STD-202G.pdf">https://www.rflambda.com/pdf/rflambda_random_vibration_MIL-STD-202G.pdf</a>

**Ordering Information**

Part Number	Modification	Description
RFSP2TA0204G5W	Standard	2GHz-4GHz SP2T PIN Diode Switch

**Important Notice**

The information contained herein is believed to be reliable. RF-Lambda makes no warranties regarding the information contained herein. RF-Lambda assumes no responsibility or liability whatsoever for any of the information contained herein. RF-Lambda assumes no responsibility or liability whatsoever for the use of the information contained herein. The information contained herein is provided "AS IS, WHERE IS" and with all faults, and the entire risk associated with such information is entirely with the user. All information contained herein is subject to change without notice. Customers should obtain and verify the latest relevant information before placing orders for RF-Lambda products. The information contained herein or any use of such information does not grant, explicitly or implicitly, to any party any patent rights, licenses, or any other intellectual property rights, whether with regard to such information itself or anything described by such information. RF-Lambda products are not warranted or authorized for use as critical components in medical, life-saving, or life sustaining applications, or other applications where a failure would reasonably be expected to cause severe personal injury or death.