

Wide Band Solid State Power Amplifier 0.8GHz-4.2GHz



Product Description

RFLUPA8M04GK is a wideband solid state power amplifier with a frequency range of 0.8 to 4.2GHz.

The power output of this amplifier is 48dBm typical. The typical small signal gain is 48dB with a flatness of ± 3 dB. This power amplifier works with a +28 VDC power supply.

The power amplifier input and output Connectors are SMA-Female.

The operating temperature of this product is -40 to +60°C.

Features

- Wideband Solid State Power Amplifier
- Gain: 48dB typical
- Output power +48dBm typical
- Supply Voltage: +28V
- 50 Ohm Matched Input/Output
- Overvoltage Protection
- Overcurrent Protection

Typical Applications

- Wireless Infrastructure
- Military and Aerospace Applications
- Test Instrumentation
- Radar Systems
- 5G Wireless Communications
- Microwave Radio Systems
- TR Modules
- Research and Development
- Cellular Base Stations

Electrical Specifications, TA = +25°C, Vcc = +28V

Parameter	Min.	Typ.	Max.	Units
Frequency Range	0.8		4.2	GHz
Small Signal Gain	45	48		dB
Gain Flatness		± 2.0		dB
Gain Variation Over Temperature (-40°C~+60°C)		± 3.0		dB
Input VSWR		1.6		: 1
Output 1dB Compression Point (P1dB)	44	46		dBm
Saturated Output Power (Psat)	47	48		dBm
Supply Current (Vcc=+28V)		9.5	12	A
Power Added Efficiency (PAE)		23		%
Turn On/Off Speed (Switch Disable)	ON	100		ns
	OFF	100		
Turn On/Off Speed (Drain Disable)	ON	200		us
	OFF	300		
Turn On/Off Speed (Gate Disable)	ON	200		us
	OFF	300		
Weight	Net	3.43 Max.		lbs.
	Including Heat sink	8.72 Max.		
Impedance		50		Ohms
Input / Output Connectors	SMA-Female			
Package Sealing	Epoxy Sealed (Standard)			
	Hermetically Sealed (Optional)			

Absolute Maximum Ratings

Parameter	Rating
Operating Voltage	+32V
RF Input Power	Psat – Large Signal Gain

Bias Up Procedure

1. Connect ground.
2. Connect input and output with 50 Ohm source/load.
(In band VSWR < 1.9:1 or >10dB return loss.)
3. Connect positive supply and make sure power supply can handle max current.

Bias Down Procedure

1. Turn off power supply
2. Remove positive supply Connection
3. Remove RF Connection
4. Remove ground

Environmental Specifications and Test Standards

Parameter	Description
Operational Temperature	-40°C to +60°C (Case Temperature)
Storage Temperature	-50°C to +105°C
Thermal Shock	-40°C → +85°C (5 Cycles / 10 hours)
**Random Vibration	MIL-STD-202G Table 214-I, Test Condition Letter C 1.5 Hours Per Axis
High Temperature Burn In	Temperature +60°C for 72 Hours
Shock	1. Weight >20g, 50g half sine wave for 11ms, Speed variation 3.44m/s 2. Weight <=20g, 100g Half sine wave for 6ms, Speed variation 3.75m/s 3. Total 18 times (6 directions, 3 repetitions per direction).
Altitude	Standard: 30,000 Ft (Epoxy Sealed Controlled Environment) Optional: Hermetically Sealed (60,000 ft. 1.0 PSI min)
Hermetically Sealed (Optional)	MIL-STD-883 (For Hermetically Sealed Units)

Typical Performance Plots

Gain@+25°C

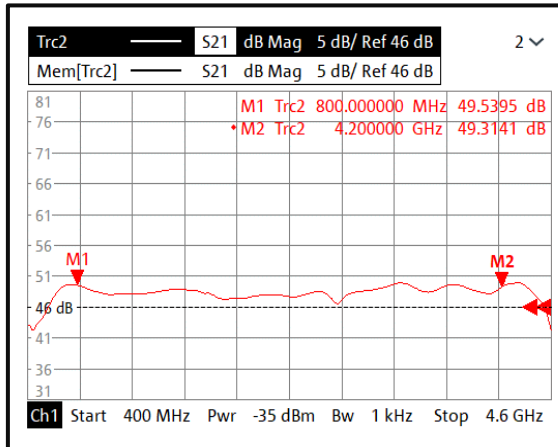

Input VSWR @+25°C

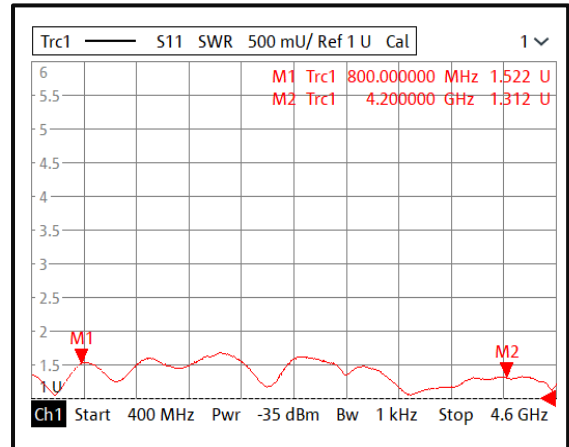

Isolation@+25°C

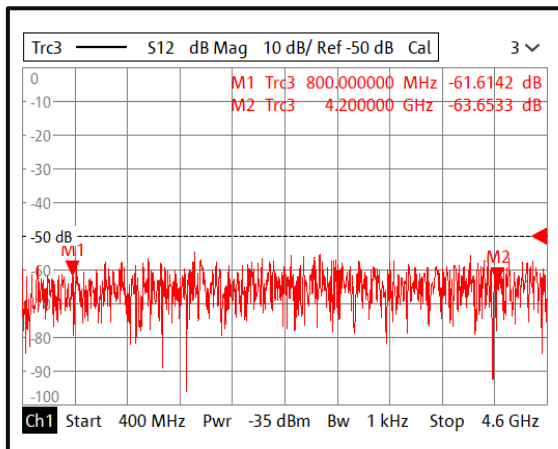

Gain@-40°C

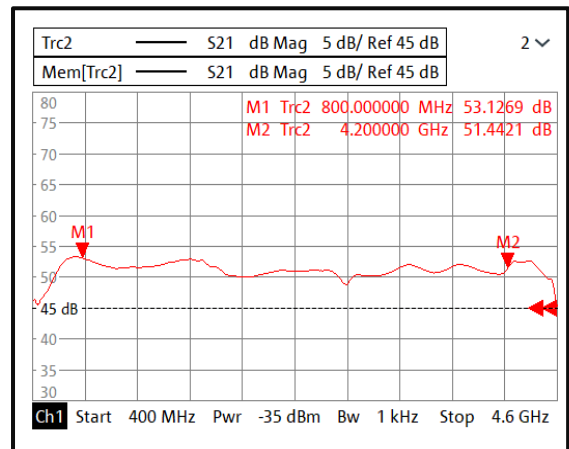

Input VSWR @-40°C

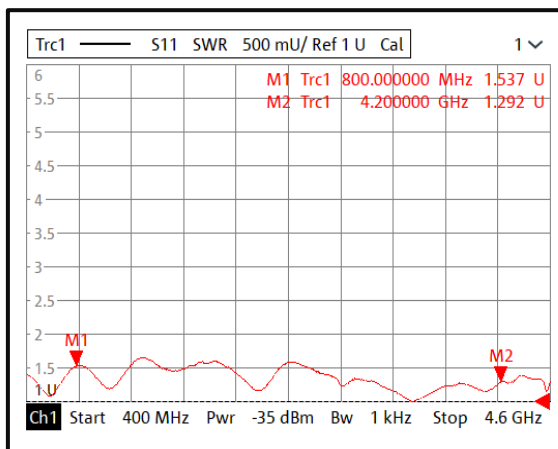

Isolation@-40°C

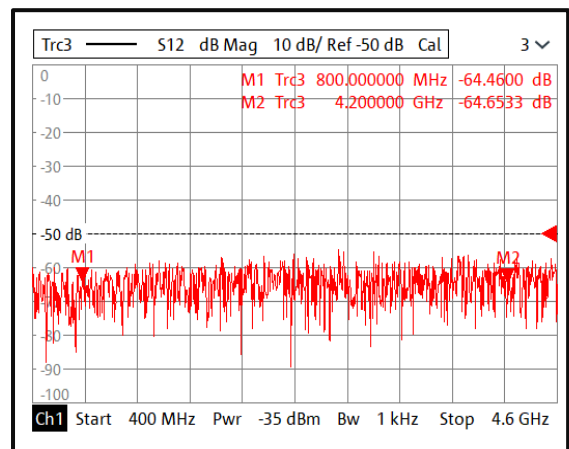

Note: Small signal VNA measurements include attenuators to protect equipment

Typical Performance Plots

Gain@+60°C

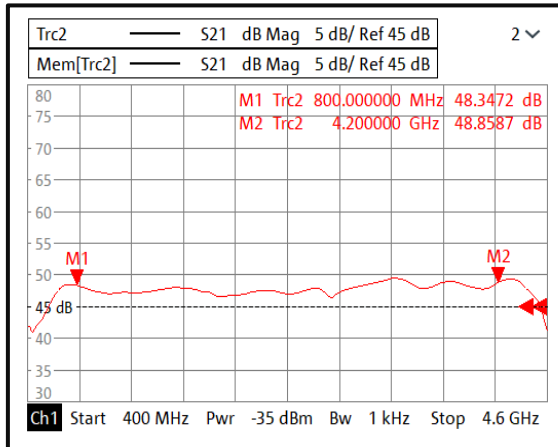

Input VSWR @+60°C

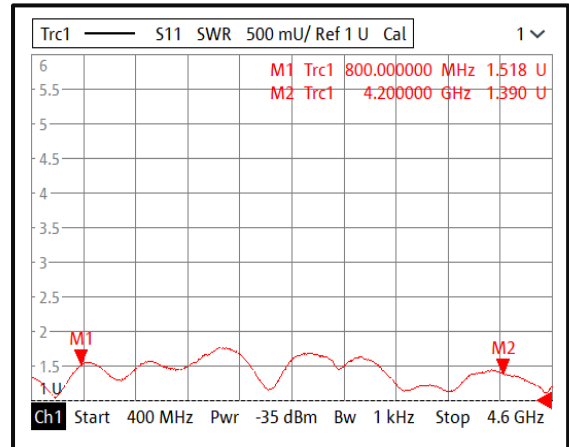

Isolation@+60°C

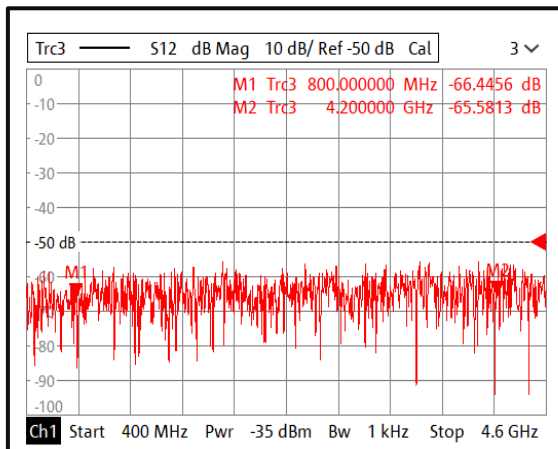

Note: Small signal VNA measurements include attenuators to protect equipment

Typical Performance Plots

Gain vs. Output Power

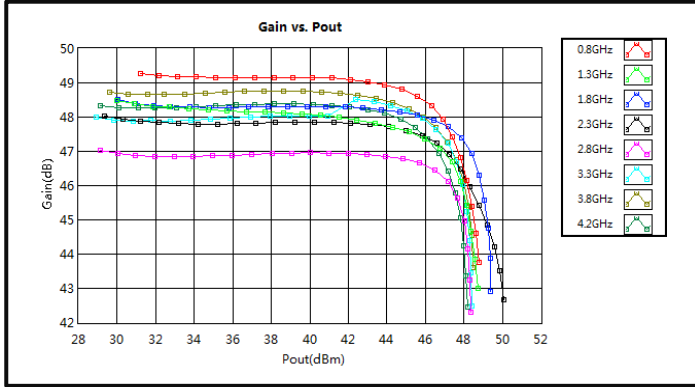

PndB vs. Frequency

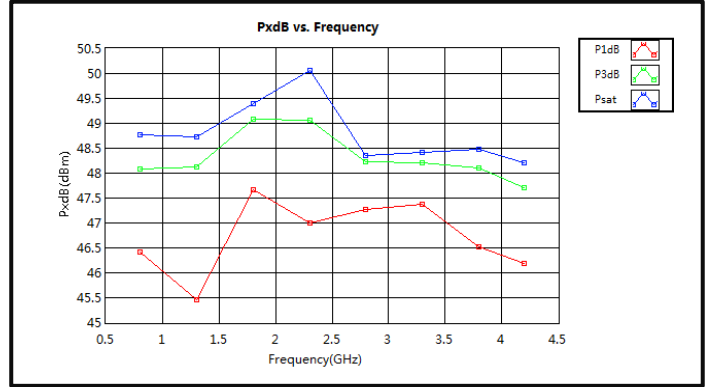

Power Added Efficiency

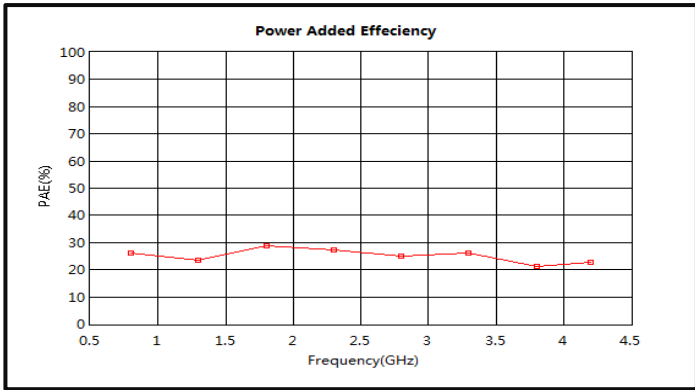

Saturation Power vs. Frequency

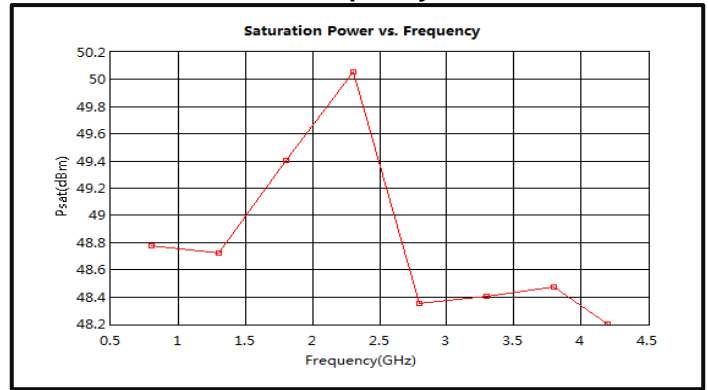

Pout vs. Pin

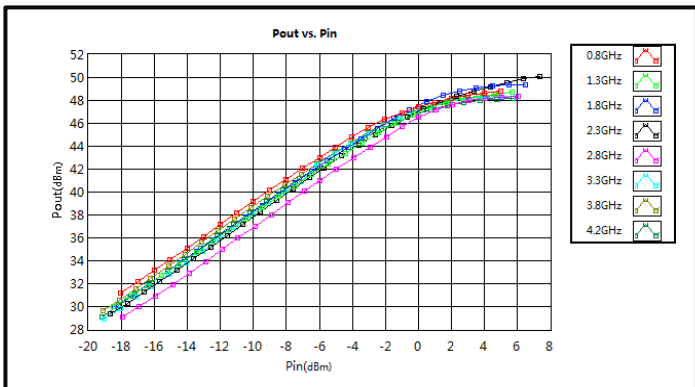

Current vs. Pout

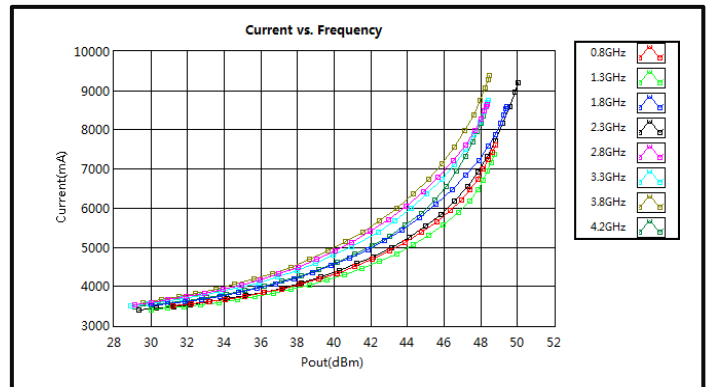

Typical Performance Plots

Left IM3 vs. Pout

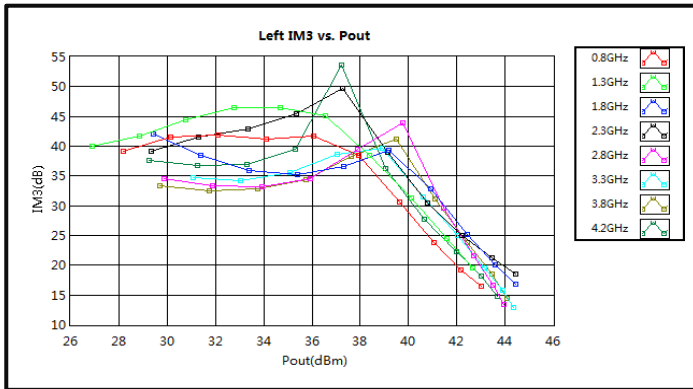

Right IM3 vs. Pout

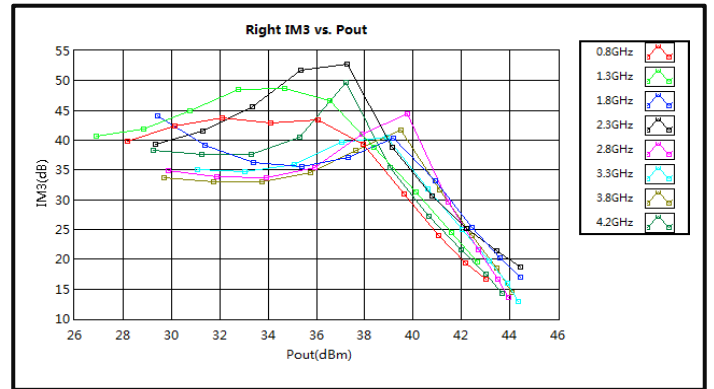

Delta IM3 vs. Pout

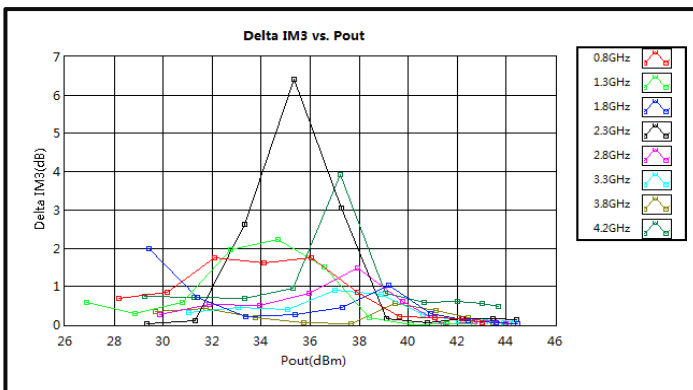

2nd Harmonic Wave Output Power

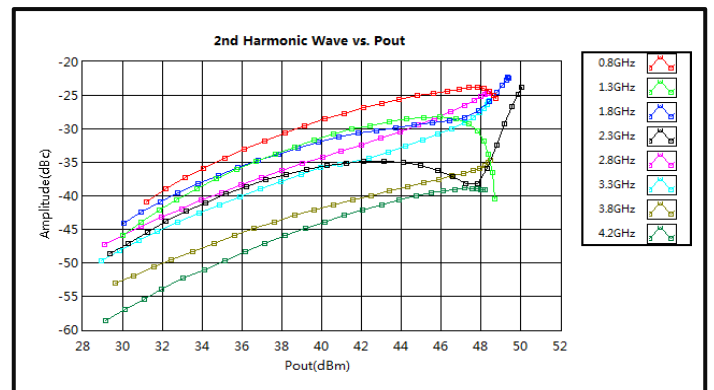

3rd Harmonic Wave Output Power

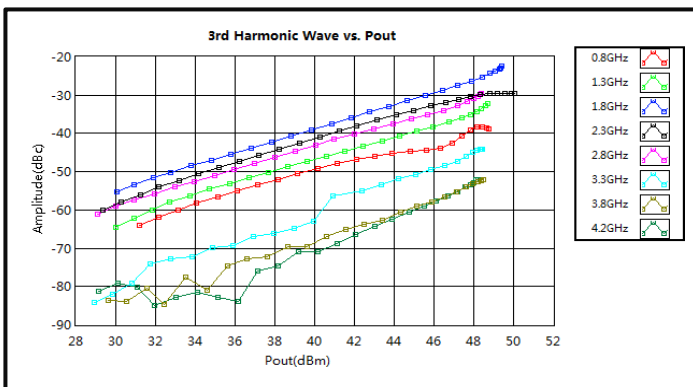

4th Harmonic Wave Output Power

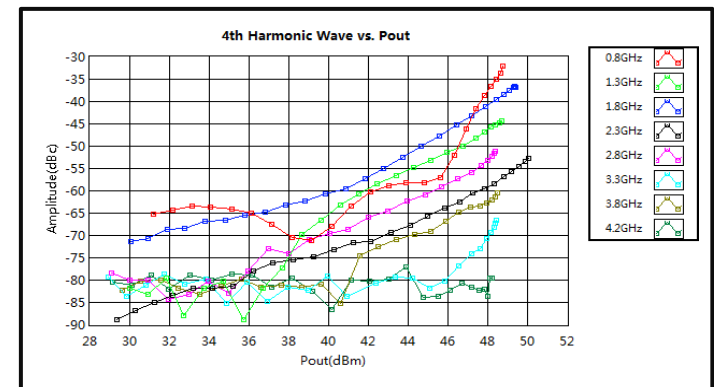

Note: IM3 test performed with 1MHz tone spacing

Interface Connector

Male D-Sub is on the housing
The mating female part number: RFCBLADB17



Pin #	Name	Function	Initial State	Description	Applied
A1	VDD	Power Supply	+28V	+28V DC is supply Voltage	Yes
A2	GND	Ground	GND	Ground	Yes
1	Reset	Control	HIGH	Resets PA when logic LOW is applied for five more seconds and released	Yes
2	Gate Disable	Control	LOW	Applying logic HIGH disables gate of amplifiers	Yes
3	Drain Disable	Control	LOW	Applying logic HIGH disables drain of amplifiers	Yes
4	RF Input Switch	Control	LOW	Applying logic HIGH turns off RF front-end switch to terminator	Yes
5	PA Off Alarm	Indicator	LOW	Pin will be latched to logic HIGH when any of the protection limit is reached	Yes
6	RF Input Over Drive	Indicator	LOW	Pin will be latched to logic HIGH when input signal is over limit	Yes
7	Temp Over	Indicator	LOW	Pin will be latched to logic HIGH when amplifier is driven over temperature	Yes
8	Current Over	Indicator	LOW	Pin will be latched to logic HIGH when drain current limit is reached	Yes
9	VSWR	Indicator	LOW	Pin will be latched to logic HIGH when output reflection is over limit	Yes
10	NC	NC	NC	NC	No
11	Temp monitor	Indicator	Voltage	Analog voltage relative to module's temperature	Yes
12	NC	NC	NC	NC	No
13	NC	NC	NC	NC	No
14	+5V	Power Supply	+5V	+5V DC is provided for reference *	Yes
15	GND	GND	GND	GND	Yes

Notes:

- HIGH/LOW voltages are standard TTL signals 0 to 0.8V = LOW. 2.8V to 5V = HIGH. Input current is 10uA.
- Matching connector and cable will be shipped with the product.
- Applied=Yes means the feature is included. Applied=No means the feature is not included with this model.
- Indicator output signals can source 24mA.

Outline Drawing

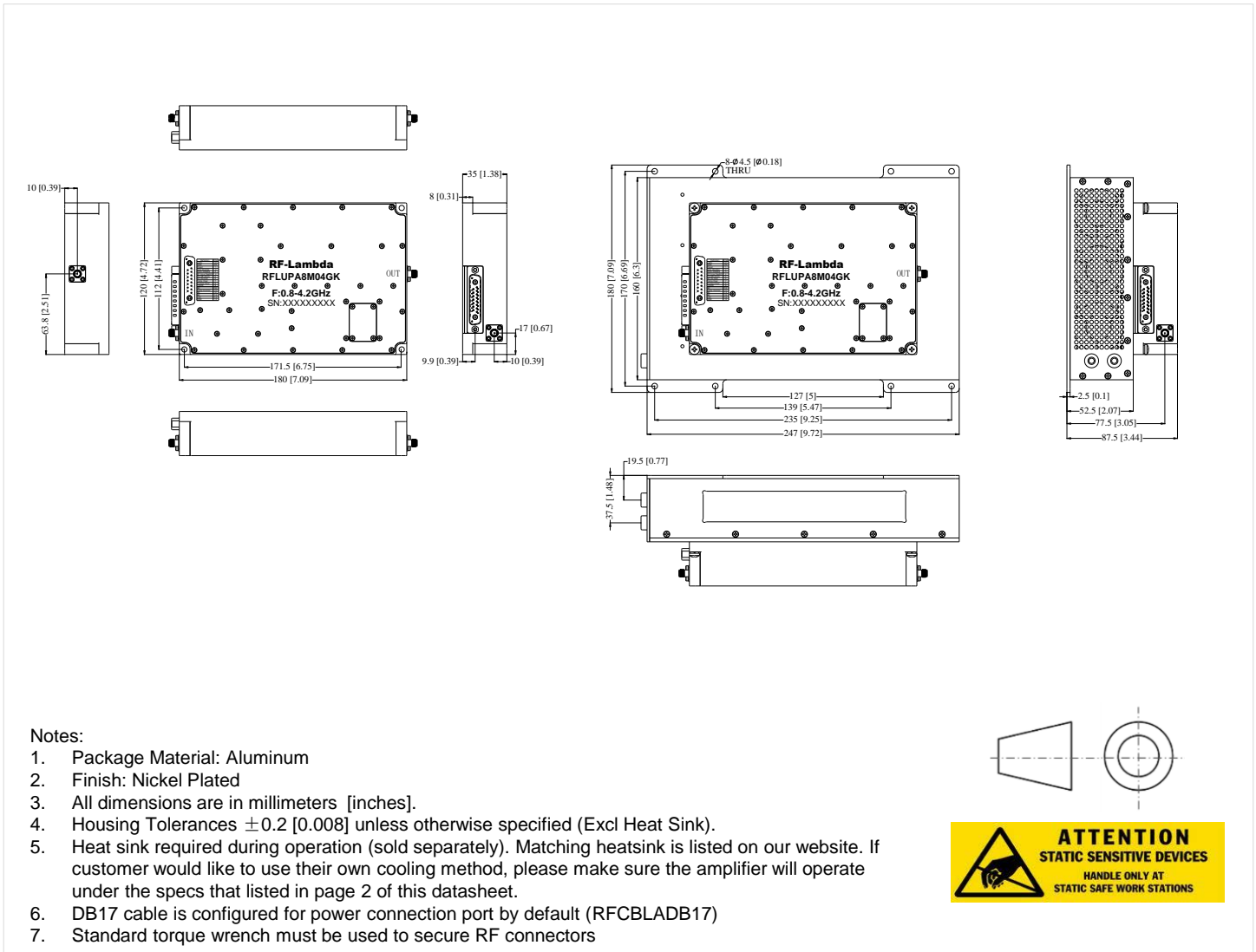

Packing List

ID	Description	QTY
1	Fig a. DB17 cable (RFCBLADB17)	1



Fig a.

Additional Information

Documentation	Webpage
ESD Policy	https://rflambda.com/pdf/rflambda_esd_control.pdf
Heatsink Lookup Specifications	https://rflambda.com/search_heatsink.jsp
Connector Torque Specifications	https://www.rflambda.com/pdf/Torque_Specifications.pdf
Random Vibration Test Standard	https://www.rflambda.com/pdf/rflambda_random_vibration_MIL-STD-202G.pdf

Ordering Information

Part Number	Modification	Description
RFLUPA8M04GK	Input and Output connectors are SMA-Female	0.8GHz–4.2GHz Power Amplifier

Amplifier Use

Ensure that the amplifier input and output ports are safely terminated into a proper 50 ohm load before turning on the power. Never operate the amplifier without a load. A proper 50 ohm load is defined as a load with impedance less than 1.9:1 or return loss larger than 10dB relative to 50 Ohm within the specified operating band width.

Power Supply Requirements

Power supply must be able to provide adequate current for the amplifier. Power supply should be able to provide 1.5 times the typical current or 1.2 times the maximum current (whichever is greater).

In most cases, RF - Lambda amplifiers will withstand severe mismatches without damage. However, operation with poor loads is discouraged. If prolonged operation with poor or unknown loads is expected, an external device such as an isolator or circulator should be used to protect the amplifier.

Ensure that the power is off when connecting or disconnecting the input or output of the amp.

Prevent overdriving the amplifier. Do not exceed the recommended input power level.

Adequate heat-sinking required for RF amplifier modules. Please inquire.

Amplifiers do not contain Thermal protection, Reverse DC polarity or Over voltage protection with the exception of a few models. Please inquire.

Proper electrostatic discharge (ESD) precautions are recommended to avoid performance degradation or loss of functionality.

What is not covered with warranty?

Each RF - Lambda amplifier will go through power and temperature stress testing. Since the die, ICs or MMICs are fragile, these are not covered by warranty. Any damage to these will NOT be free to repair.

Important Notice

The information contained herein is believed to be reliable. RF-Lambda makes no warranties regarding the information contained herein. RF-Lambda assumes no responsibility or liability whatsoever for any of the information contained herein. RF-Lambda assumes no responsibility or liability whatsoever for the use of the information contained herein. The information contained herein is provided "AS IS, WHERE IS" and with all faults, and the entire risk associated with such information is entirely with the user. All information contained herein is subject to change without notice. Customers should obtain and verify the latest relevant information before placing orders for RF-Lambda products. The information contained herein or any use of such information does not grant, explicitly or implicitly, to any party any patent rights, licenses, or any other intellectual property rights, whether with regard to such information itself or anything described by such information.

RF-Lambda products are not warranted or authorized for use as critical components in medical, life-saving, or life sustaining applications, or other applications where a failure would reasonably be expected to cause severe personal injury or death.