

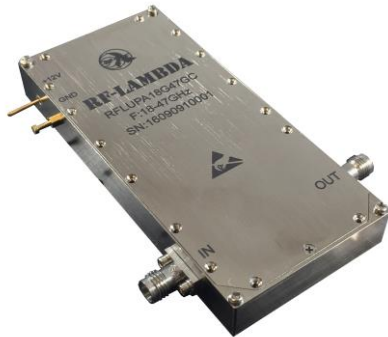

1W Ultra Wide Band Power Amplifier 18GHz~47GHz



Features

- Ultra Wideband Solid State Power Amplifier
- Gain: 30dB Typical
- Psat: +29dBm Typical
- Supply Voltage: +12V

Typical Applications

- Military & Defense Applications
- Wireless Infrastructure
- Test and Measurement

Electrical Specifications, $T_A = +25^\circ\text{C}$, $V_{CC} = +12\text{V}$

Parameter	Min.	Typ.	Max.	Min.	Typ.	Max.	Units
Frequency Range	20		30	30		47	GHz
Gain	25	37		25	33		dB
Gain Flatness		± 7			± 5		dB
Gain Variation Over Temperature(-45 ~ +85)		± 3			± 3		dB
Noise Figure		13			13		dB
Input Return Loss		9			8		dB
Output Return Loss		10			10		dB
Output 1dB Compression Point (P1dB)	24	27		24	27		dBm
Output 3dB Compression Point (P3dB)	25	28		25	28		dBm
Output Third Order Intercept (IP3)		34			33		dBm
Supply Current (+12 VDC)		1700	2000		1700	2000	mA
Isolation S12	79	85		76	86		dB
Input Max Power (No damage)	15						dBm
Weight	300						g
Impedance	50						Ohms
Input / Output Connectors	RFLUPA18G47GC - 2.4mm-Female RFLUPA18G47GCK - 2.92mm Female						
Finish	Nickel Plated						
Material	Aluminum / Copper						

* P1dB, P3dB and Psat power testing signal: 200 μ s pulse width with 10% duty cycle.

* For average CW power testing, a 5dB back off from Psat is required unless water/oil cooling system is applied.

Ultra Wide Band 1W Power Amplifier 18-47GHz



Absolute Maximum Ratings	
Supply Voltage	+16 VDC
RF Input Power	+15 dBm

Note: Maximum RF input power is set to assure safety of amplifier. Input power may be increased at own risk to achieve full power of amplifier. Please reference gain and power curves.

Biasing Up Procedure	
Step 1	Connect input and output with 50 Ohm source/load. (in band VSWR<1.9:1 or >10dB return loss)
Step 2	Connect Ground Pin
Step 3	Connect VDC
Power OFF Procedure	
Step 1	Turn Off VDC
Step 2	Remove RF Connection
Step 3	Remove Ground

Environmental Specifications and Test Standards

Parameter	Standard	Description
Operational Temperature	MIL-STD-39016	-45°C~+55°C (Case Temperature less than 85C)
Storage Temperature		-50°C~+125°C
Thermal Shock		1 Hour@ -45°C → 1 Hour @ +85°C (5 Cycles)
Random Vibration		Acceleration Spectral Density 6 (m/s) Total 92.6 RMS
Electrical & Temperature Burn In		Temperature +85°C for 72 Hours
Shock		1. Weight >20g, 50g half sine wave for 11ms, Speed variation 3.44m/s 2. Weight <=20g, 100g Half sine wave for 6ms, Speed variation 3.75m/s 3. Total 18 times (6 directions, 3 repetitions per direction).
Altitude		Standard: 30,000 Ft (Epoxy Sealed Controlled Environment) Optional: Hermetically Sealed (60,000 ft. 1.0 PSI min)
Hermetically Sealed (Optional)	MIL-STD-883	MIL-STD-883 (For Hermetically Sealed Units)

Note: The operating temperature for the unit is specified at the package base. It is the user's responsibility to ensure the part is in an environment capable of maintaining the temperature within the specified limits



Ordering Information	
Part No.	Description
RFLUPA18G47GC	18GHz~47GHz Power Amplifier – 2.4mm Female Connectors
RFLUPA18G47GCK	18GHz~47GHz Power Amplifier – 2.92mm Female Connectors

Amplifier Use

Ensure that the amplifier input and output ports are safely terminated into a proper 50 ohm load before turning on the power. Never operate the amplifier without a load. A proper 50 ohm load is defined as a load with impedance less than 1.9:1 or return loss larger than 10dB relative to 50 Ohm within the specified operating band width.

Power Supply Requirements

Power supply must be able to provide adequate current for the amplifier. Power supply should be able to provide 1.5 times the typical current or 1.2 times the maximum current (whichever is greater).

In most cases, RF - Lambda amplifiers will withstand severe mismatches without damage. However, operation with poor loads is discouraged. If prolonged operation with poor or unknown loads is expected, an external device such as an isolator or circulator should be used to protect the amplifier.

Ensure that the power is off when connecting or disconnecting the input or output of the amp.

Prevent overdriving the amplifier. Do not exceed the recommended input power level.

Adequate heat-sinking required for RF amplifier modules. Please inquire.

Amplifiers do not contain Thermal protection, Reverse DC polarity or Over voltage protection with the exception of a few models. Please inquire.

Proper electrostatic discharge (ESD) precautions are recommended to avoid performance degradation or loss of functionality.

What is not covered with warranty?

Each RF - Lambda amplifier will go through power and temperature stress testing.

Since the die, ICs or MMICs are fragile, these are not covered by warranty. Any damage to these will NOT be free to repair.



Gain

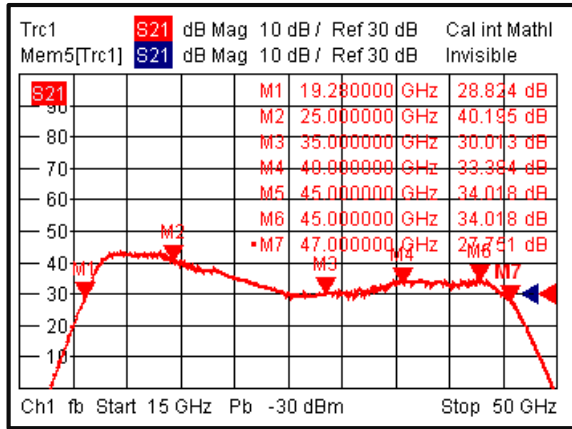

Input Return Loss

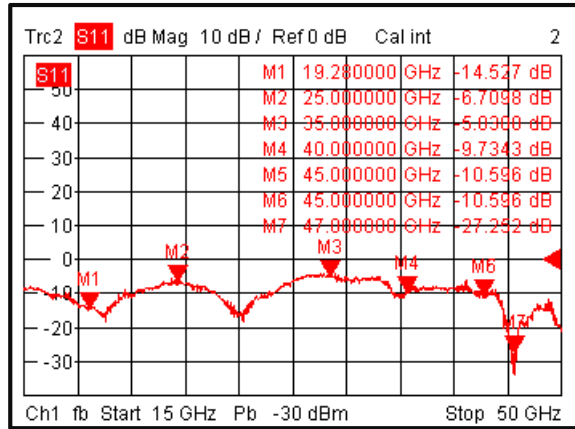

Isolation

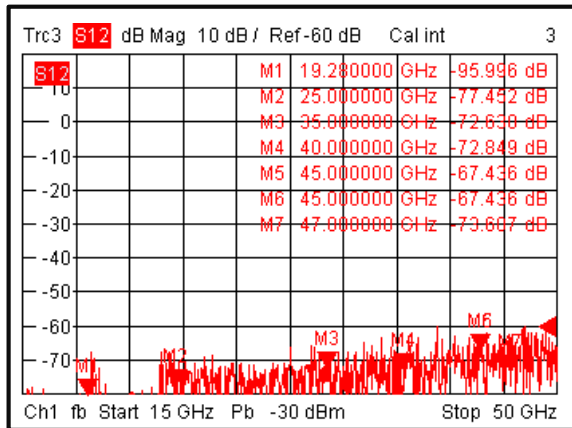

Output Return Loss

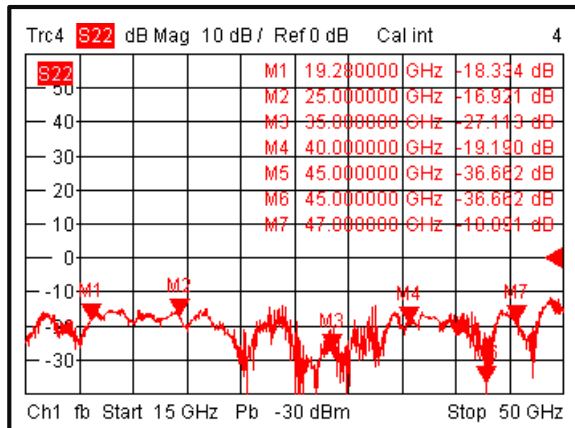

Note: Input/output return loss measurements include attenuators to protect equipment

Ultra Wide Band 1W Power Amplifier 18-47GHz



RF-LAMBDA

The power beyond expectations

RFLUPA18G47GC RFLUPA18G47GCK

Gain vs Pout (Pulsed input)

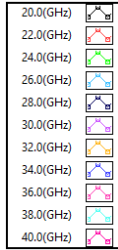
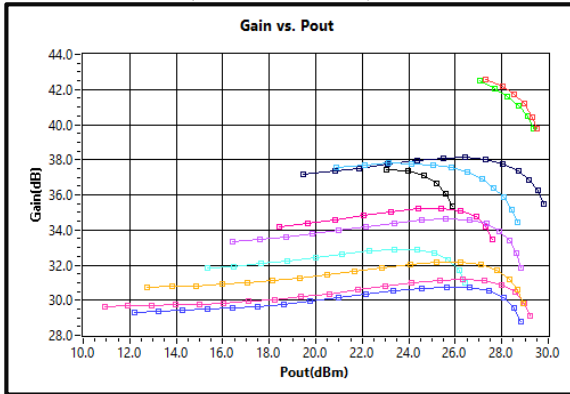

Current vs. Pout (Pulsed input)

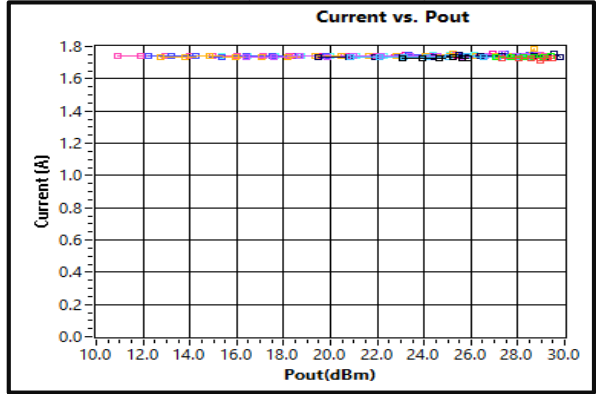

P1dB vs. Frequency (Pulsed input)

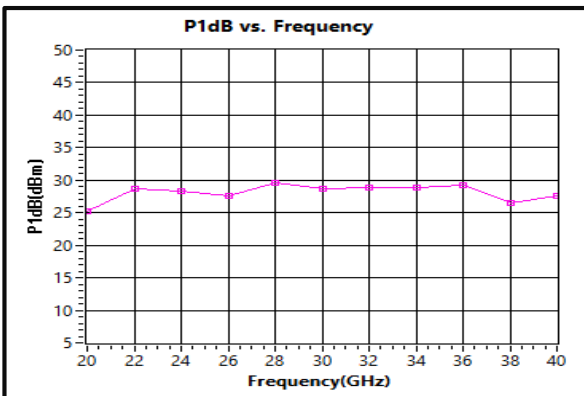

P3dB vs. Frequency (Pulsed input)

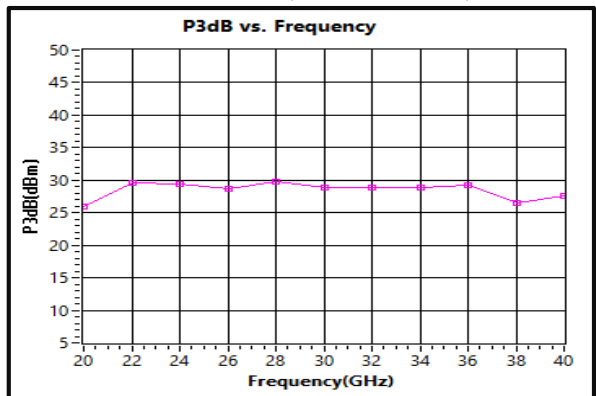

Gain vs Pout (CW input)

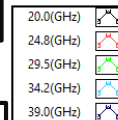
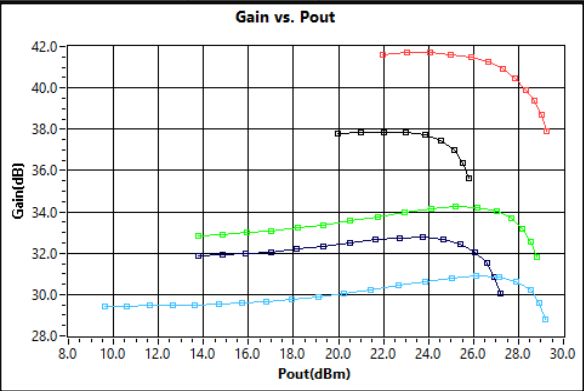

Current vs Pout (CW input)

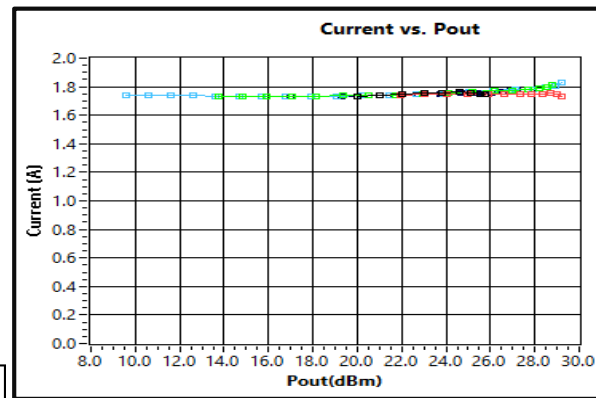

P1dB vs Frequency (CW input)

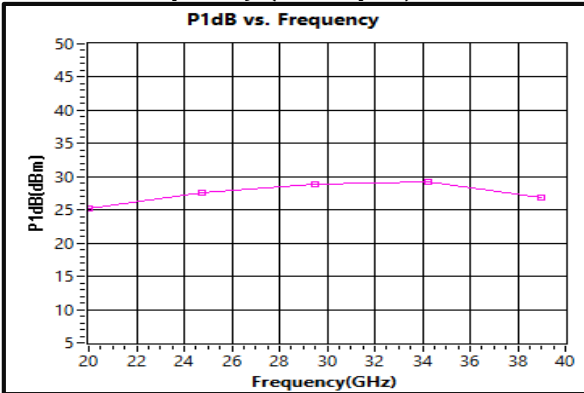

P3dB vs Frequency (CW input)

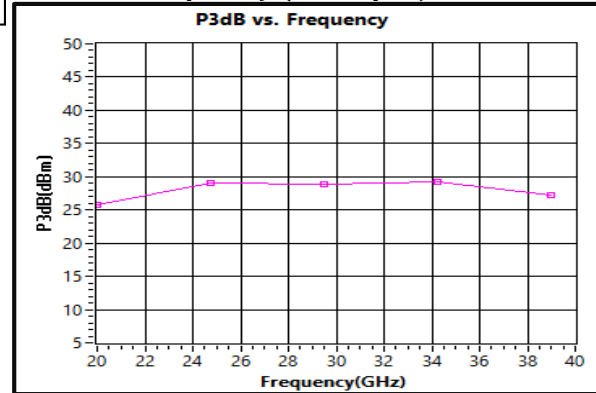

Ultra Wide Band 1W Power Amplifier 18-47GHz



RF-LAMBDA

The power beyond expectations

RFLUPA18G47GC RFLUPA18G47GCK

Noise Figure (20-40GHz)

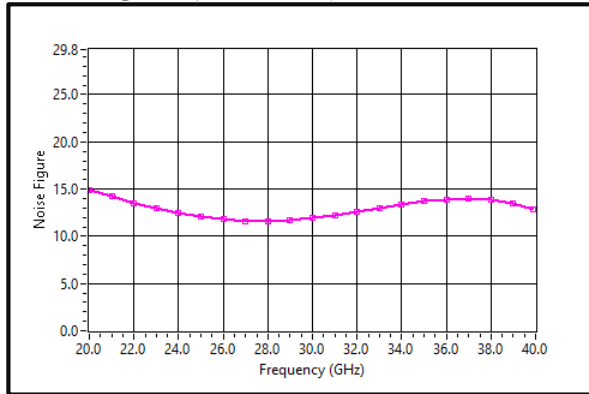

OIP3 vs Frequency

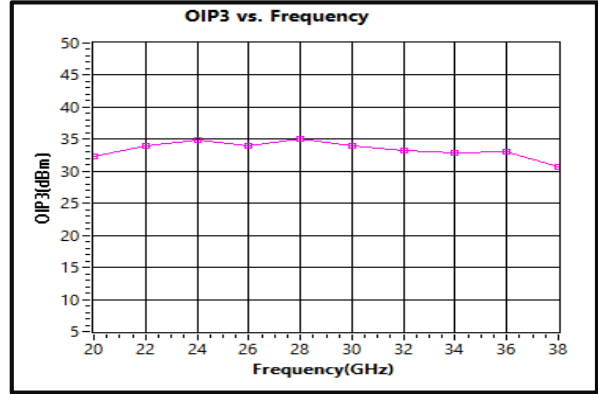

Ultra Wide Band 1W Power Amplifier 18-47GHz



RF-LAMBDA

The power beyond expectations

RFLUPA18G47GC
RFLUPA18G47GCK

Housing Outline:

All Dimensions in mm

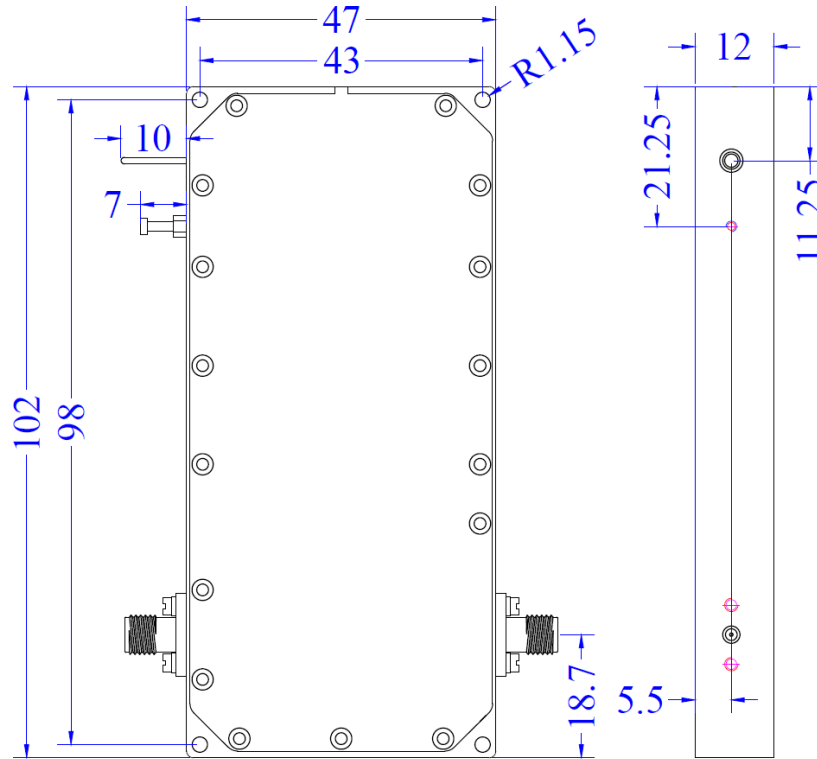

*****Heat Sink and cooling fan required during operation*****



Ultra Wide Band 1W Power Amplifier 18-47GHz



Heatsink Outline:

All Dimensions in mm

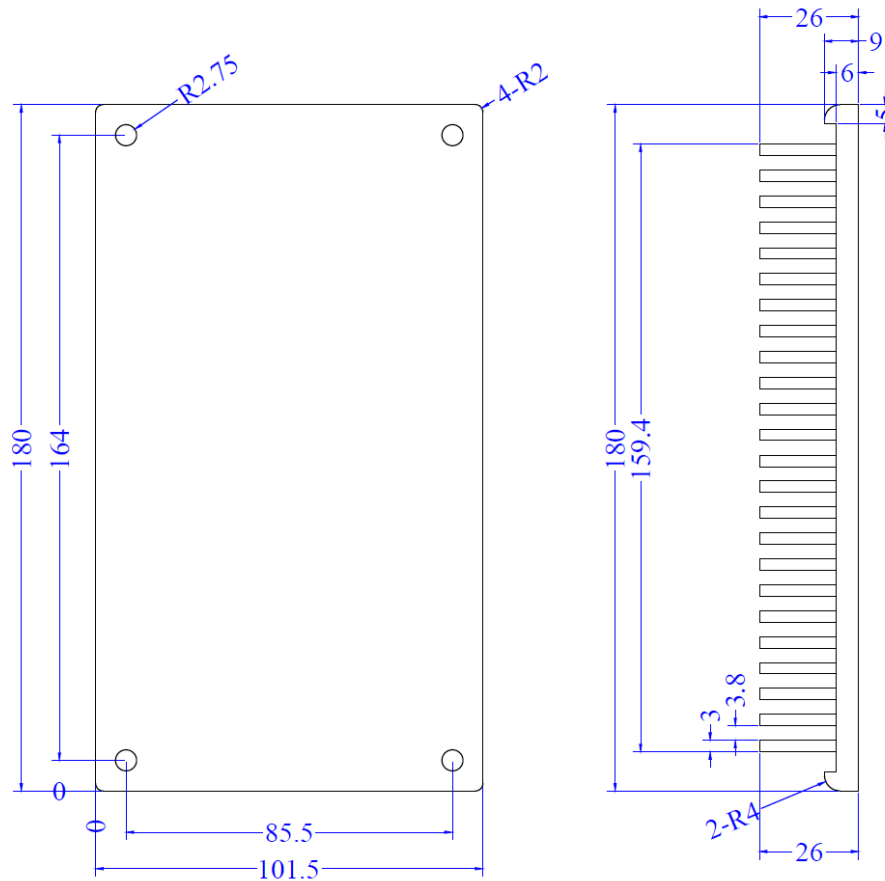

Heat Sink and cooling fan required during operation



Important Notice

The information contained herein is believed to be reliable. RF-Lambda makes no warranties regarding the information contained herein. RF-Lambda assumes no responsibility or liability whatsoever for any of the information contained herein. RF-Lambda assumes no responsibility or liability whatsoever for the use of the information contained herein. The information contained herein is provided "AS IS, WHERE IS" and with all faults, and the entire risk associated with such information is entirely with the user. All information contained herein is subject to change without notice. Customers should obtain and verify the latest relevant information before placing orders for RF-Lambda products. The information contained herein or any use of such information does not grant, explicitly or implicitly, to any party any patent rights, licenses, or any other intellectual property rights, whether with regard to such information itself or anything described by such information.

RF-Lambda products are not warranted or authorized for use as critical components in medical, life-saving, or life sustaining applications, or other applications where a failure would reasonably be expected to cause severe personal injury or death.