

HIGH POWER PHASE SHIFTER TUNER

--- RFPST0002W2

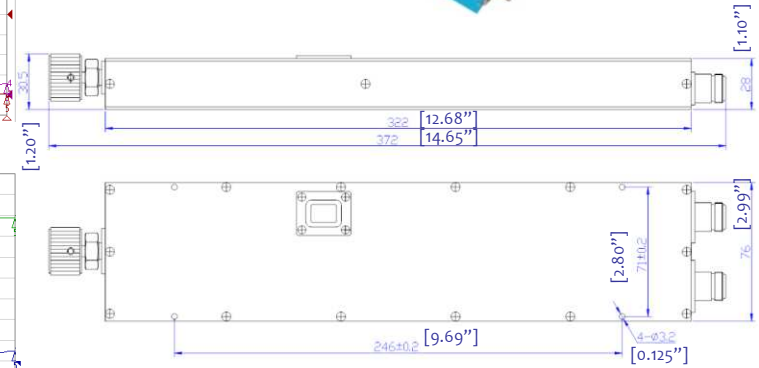

1.0	Mechanical Specifications	
1.1	Coaxial Connector	N-Female (SMA model optional)
1.2	Size	13.31" x 3.46" x 1.18" (338 × 88 × 30mm)
1.3	Weight	1kg
1.4	External Body Finish	Body painted with blue/black epoxy enamel

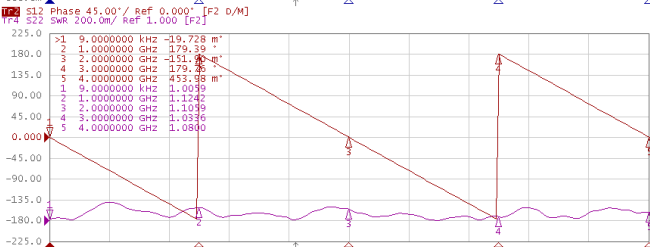
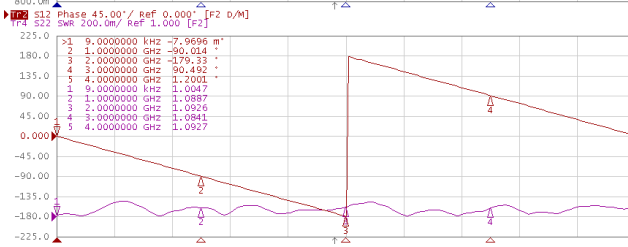
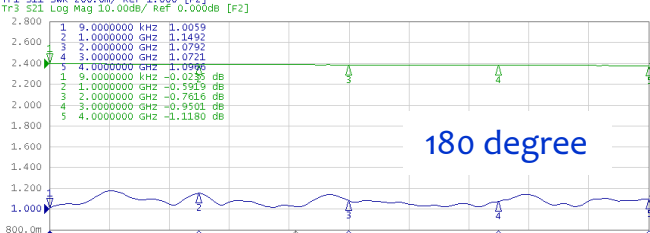
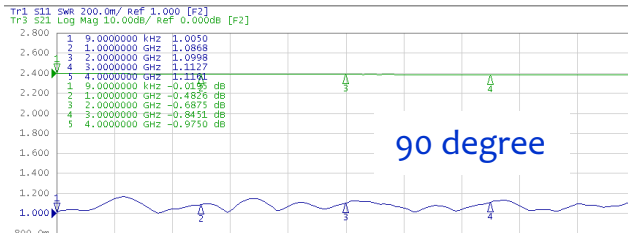
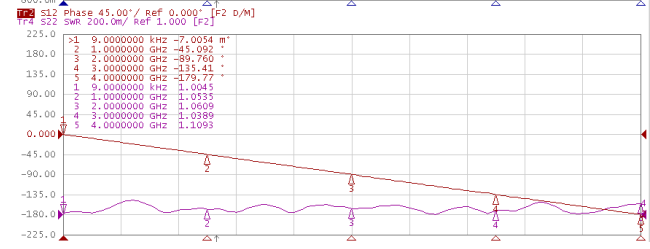
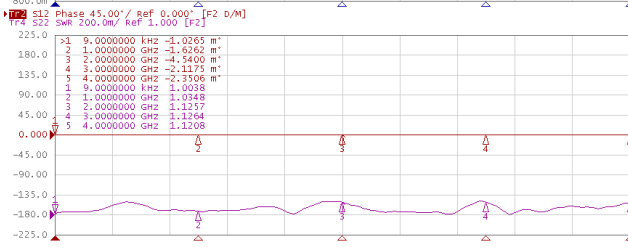
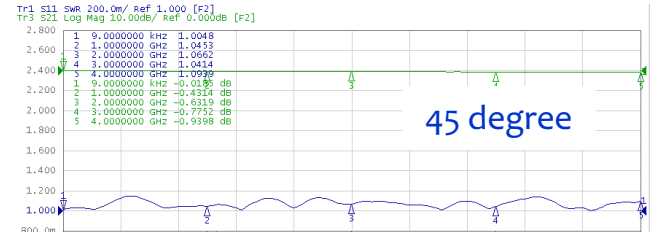

2.0	Environment specifications	
2.1	Operation Temp.	-10°C~+50°C
2.2	Storage Temp.	-40°C~+70°C
2.3	Altitude	45000 ft
2.4	Vibration	10g rms (15 degree 2KHz)
2.5	Humidity	100% RH at 35°C, 95%RH at 40 deg c
2.6	Shock	20G for 11msec

3.0	Electrical Specifications						
Part Number	Frequency (GHz)	Insertion Loss (dB)	Phase Adjustment	VSWR max.	Power (CW W)	PK Power (KW)	
RFPST0002W2	DC-2	<1.25	360° ***	1.5	100	5	
***Phase Adjustment Range specification ONLY refer to the highest frequency point. Total Phase Adjustment Range is proportion of Frequency range. HALF the frequency range, HALF of the phase adjustment range. (For example 8GHz range 360°, then 4GHz will be 180° total range)							

PAGE 1 OF 1

DATE Oct 8th 2006

DESIGN RFPCC

RF-LAMBDA RFPCC

CAD MODEL REVISION 10

ASSEMBLY REVISION VS52

ASSEMBLY NAME RFLVR07

DRAWING NUMBER D05-A

RFPST0002W2
HIGH POWER
PHASE SHIFTER
TUNER

www.rflambda.com

RF-LAMBDA

SIZE LT SHEETS 1 OF 1