

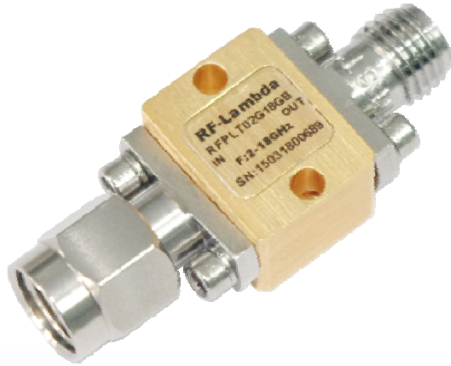

## 2-18 GHz Power Limiter



### Features

- Ultra Wide Band Operation 2-18GHz
- Passive, High Isolation Limiter
- Low Insertion Loss and Good Return Loss
- High Power Handle Capability up to 6W
- Customization available upon request



### Electrical Specifications, $T_A=25\text{ }^\circ\text{C}$

Parameters	Min.	Typ.	Max.	Min.	Typ.	Max.	Units
Frequency Range	2-8		8-18				GHz
CW Input Power			6			6	CW
Peak Power(30us with 5% duty cycle)			20			20	W
Insertion Loss		1.2	1.5		1.6	2	dB
VSWR		1.6	2		1.7	2	
Flat Leakage		17			17		dBm
Peak Power Leakage			30			30	dBm
Operating Temperature	-45 ~ +85						$^\circ\text{C}$
Weight	8						g
Input / Output Connector	SMA-Male/SMA-Female						
Material	Aluminum						
Finishing	Gold Plating						

### Environment specifications

Operational Temperature ( $^\circ\text{C}$ )	-45 to +85
Storage Temperature ( $^\circ\text{C}$ )	-55 to +125
Altitude	30,000 ft. (Epoxy Seal Controlled environment) 60,000 ft 1.0psi min (Hermetically Seal Un-controlled environment) ( Optional )
Vibration	25g rms (15 degree 2KHz) endurance, 1 hour per axis
Humidity	100% RH at 35c, 95%RH at 40 deg c
Shock	20G for 11msc half sin wave,3 axis both directions



### Typical Performance Plots

#### Insertion Loss

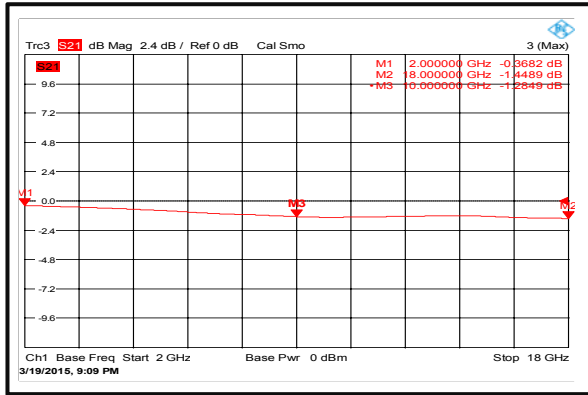

#### Input VSWR

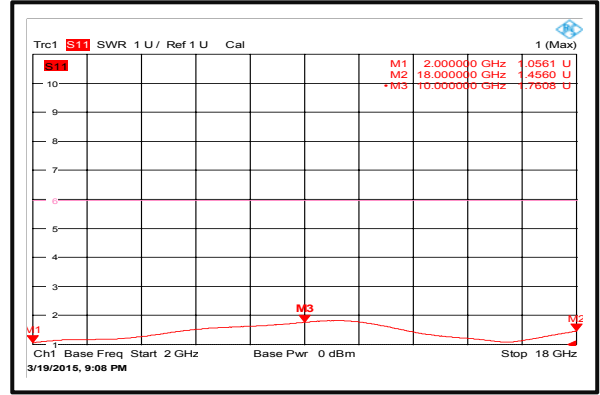

#### Output VSWR

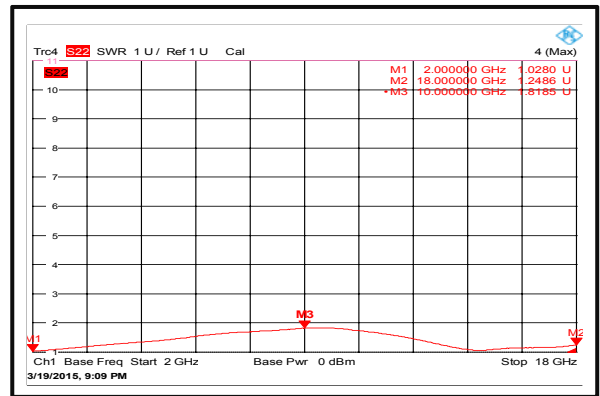

### Outline Drawing:

All Dimensions in mm (inches)

Tolerance  $\pm 0.1$  (0.0039)

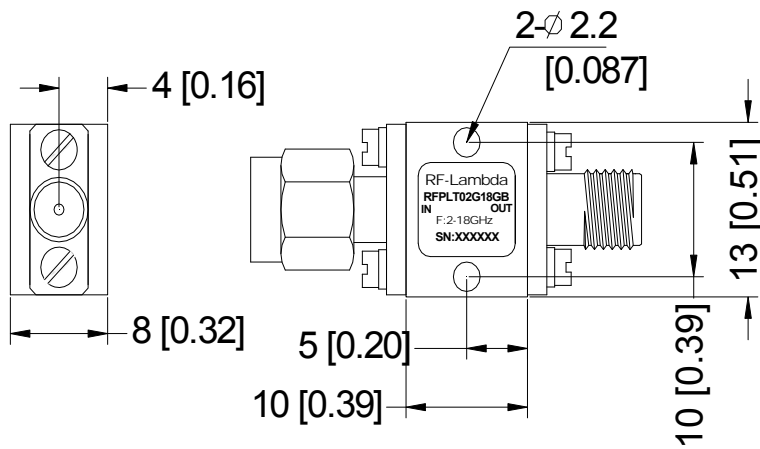

### Important Notice

The information contained herein is believed to be reliable. RF-Lambda makes no warranties regarding the information contained herein. RF-Lambda assumes no responsibility or liability whatsoever for any of the information contained herein. RF-Lambda assumes no responsibility or liability whatsoever for the use of the information contained herein. The information contained herein is provided "AS IS, WHERE IS" and with all faults, and the entire risk associated with such information is entirely with the user. All information contained herein is subject to change without notice. Customers should obtain and verify the latest relevant information before placing orders for RF-Lambda products. The information contained herein or any use of such information does not grant, explicitly or implicitly, to any party any patent rights, licenses, or any other intellectual property rights, whether with regard to such information itself or anything described by such information. RF-Lambda products are not warranted or authorized for use as critical components in medical, life-saving, or life sustaining applications, or other applications where a failure would reasonably be expected to cause severe personal injury or death.