



RF-LAMBDA

The power beyond expectations

RFDC1G4G30N

WIDE BAND 50W N TYPE DIRECTIONAL COUPLER 1.0GHZ-4.0GHZ



- Wide band performance 1.0GHz-4.0GHz
- power operation up to 50W CW
- Compact size and low loss.
- Low passive inter-modulation product.
- Customized unit available.
- Applicable for base station, repeaters of CMDA cellular network

WIDE BAND 50W SERIES DIRECTIONAL COUPLER 1.0GHZ-4.0GHZ

Electrical Specifications			
Frequency Range:	1.0-4.0GHz	Power	50W CW
Amplitude Balance	n/a	Insertion Loss / VSWR	0.4dB 1.3:1
Directivity	18dB	Coupling	30dB
Environmental Specifications			
Operational Temp.	-55°C to 85°C base plate	Storage Temp.	-55°C to 100°C base plate
Altitude	45,000 ft		
Mechanical Specifications			
Humidity	95% relative humidity, 65°C 96Hour	Mechanical shock	30G, 11mSec half sin wave, 3 axis both directions
Vibration:	14.2g RMS (15-2000Hz) functional	Connectors:	N-Female Brass, Nickel Plate
	16.2g RMS (15-2000Hz) endurance, 1 hour/axis		Beryllium Copper, Gold Plate PIN



RF-LAMBDA

The power beyond expectations

RFDC1G4G30N

DRAWING:

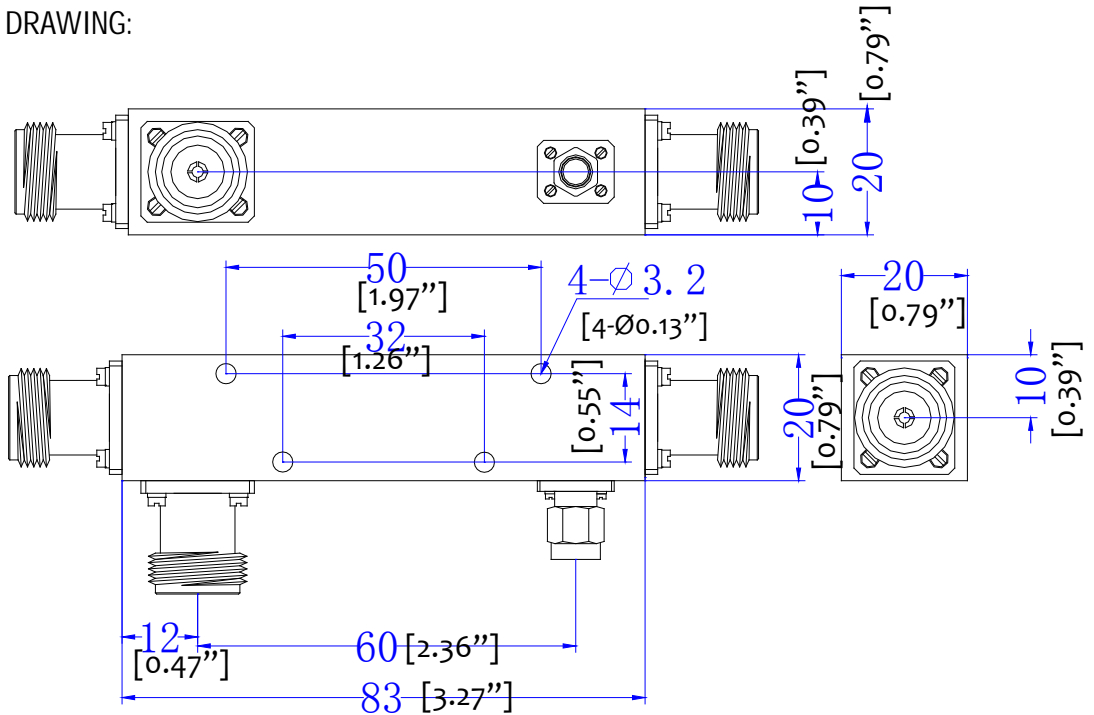

WIDE BAND 50W SERIES DIRECTIONAL COUPLER 1.0GHZ-4.0GHZ