



AC 110V/220V 9W Power Amplifier 27GHz~34GHz

- High output power up to 39dBm Psat
- Aerospace and military application
- High Peak to average handle capability
- High Linearity and low noise figure
- All specifications can be modified upon request



Parameter	Min	Type	Max	Units
Frequency Range	27 ~ 34			GHz
Gain	30	35	43	dB
Gain Variation Over Temperature		6	8	dB
Input Return Loss		10		
Output Return Loss		20		
Output Power For 1dB Compression (P-1dB)	36	37	38	dBm
Output Power For dB Compression (P-3dB)	36	38	39.5	
IM3 @ Pout/Tone = 33 dBm		-42		dBc
IM5 @ Pout/Tone = 33 dBm		-42		dBc
Supply Current (Idd) (Vdd=+28V)		400		mA
Power Supply		24		V
Isolation S12		70		dB
Input Max		22dBm		dBm
Weight	365			g
Impedance	50			Ohms
Input /Output Connector	2.92-Female			
Finishing	Gold plating			
Material	Aluminum/copper			

AC 110V/220V 9W Power Amplifier 27GHz~34GHz



RF-LAMBDA

The power beyond expectations

RAMP27G31GA

Absolute Maximum Ratings	
Biassing	110V /220V AC
Input continuous wave power	22dBm
Storage Temperature (C°)	-50 ~ +125

Ordering Information		
Part No	ECCN	Description
RAMP27G31GA	3A001.b.2.c	27GHz~34GHz Power Amplifier

Biassing Up Procedure	
Step 1	Connect input and output
Step 2	Connect Ground Pin
Step 3	Connect AC

Power OFF Procedure	
Step 1	Turn off AC
Step 2	Remove RF connection
Step 3	Remove Ground.

Environment specifications	
Operational Temperature (C°)	-45 ~ +85 (Case Temperature must be less than 85C all time)
Storage Temperature (C°)	-50 ~ +125
Altitude	30,000 ft (Controlled environment) 60,000 ft 1.0psi min (Hermetically Seal Un-controlled environment)
Vibration	35g rms (15 degree 2KHz)
Humidity	100% RH at 35c, 95%RH at 40 deg c
Shock	20G for 11msc

AC 110V/220V 9W Power Amplifier 27GHz~34GHz

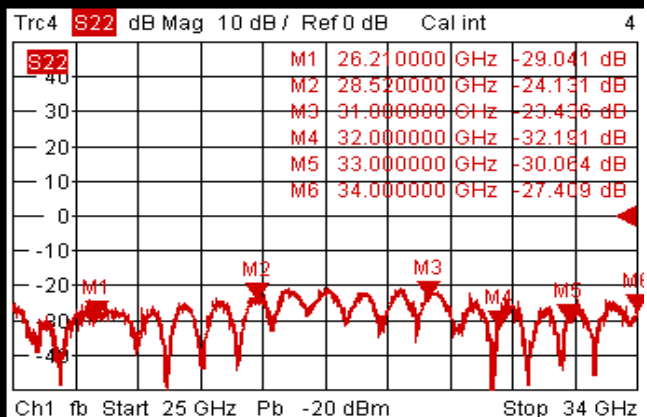
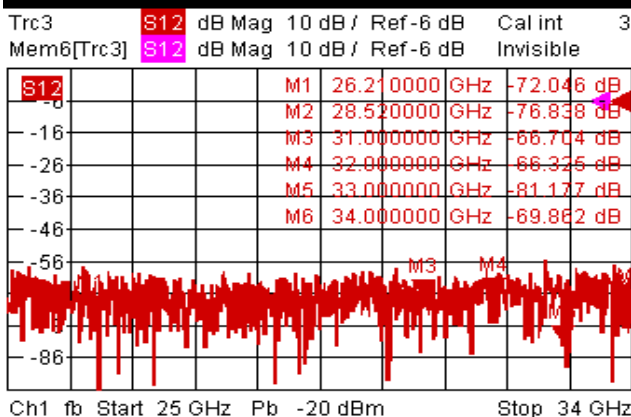
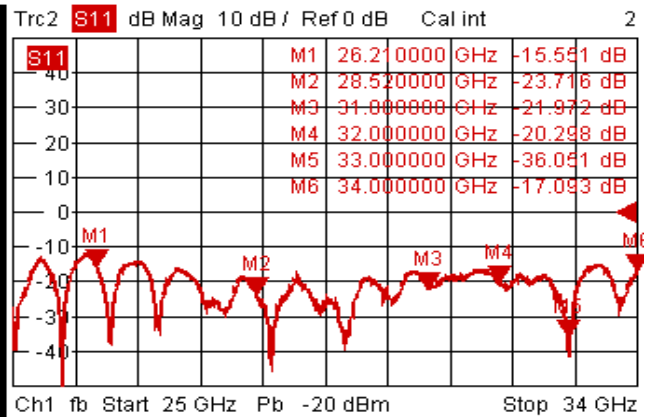
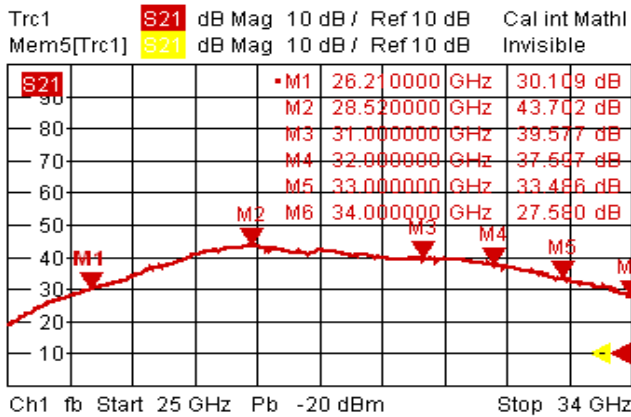



RF-LAMBDA

The power beyond expectations

RAMP27G31GA

Gain vs. output power

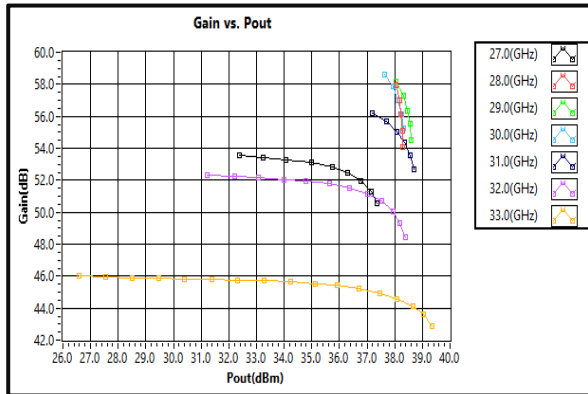

P1dB vs. Frequency

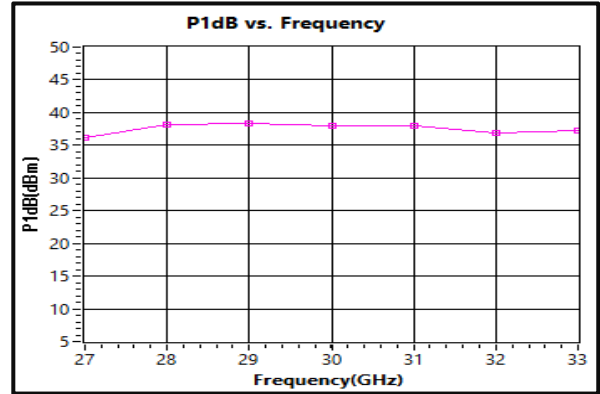

Output Third Order Intercept (IP3)

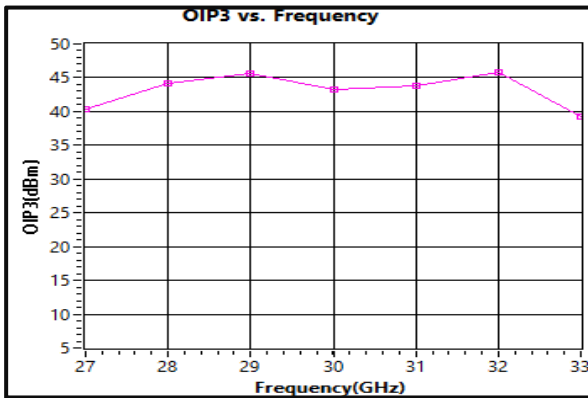

P3dB vs. Frequency

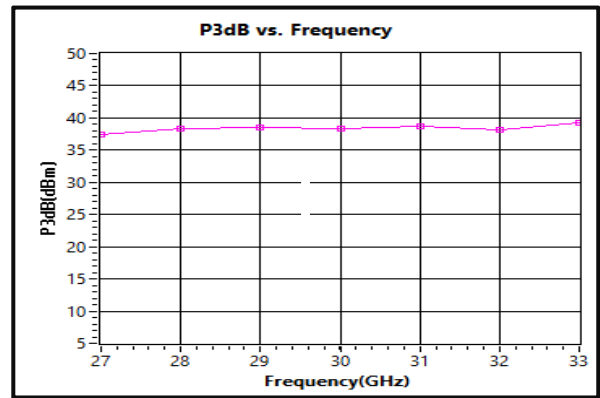

AC 110V/220V 9W Power Amplifier 27GHz~34GHz



Outline Drawing:

All Dimensions in mm (inches)

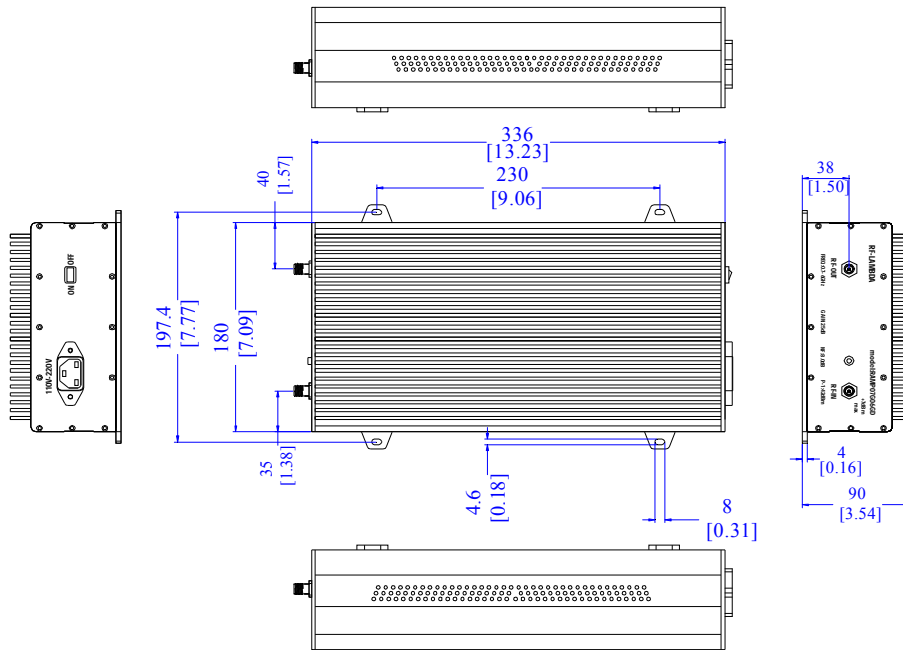

Important Notice

The information contained herein is believed to be reliable. RF-Lambda makes no warranties regarding the information contained herein. RF-Lambda assumes no responsibility or liability whatsoever for any of the information contained herein. RF-Lambda assumes no responsibility or liability whatsoever for the use of the information contained herein. The information contained herein is provided "AS IS, WHERE IS" and with all faults, and the entire risk associated with such information is entirely with the user. All information contained herein is subject to change without notice. Customers should obtain and verify the latest relevant information before placing orders for RF-Lambda products. The information contained herein or any use of such information does not grant, explicitly or implicitly, to any party any patent rights, licenses, or any other intellectual property rights, whether with regard to such information itself or anything described by such information.

RF-Lambda products are not warranted or authorized for use as critical components in medical, life-saving, or life sustaining applications, or other applications where a failure would reasonably be expected to cause severe personal injury or death.

AC 110V/220V 9W Power Amplifier 27GHz~34GHz